



# DOOR TECH MANUAL

2025



# TABLE OF CONTENTS

## FIBERGLASS DOORS SPECIFICATIONS OVERVIEW

|                             |    |
|-----------------------------|----|
| Features                    | 04 |
| Build Type Options          | 05 |
| Reinforced Blocking Options | 06 |
| Edge Prep Details           | 08 |
| Hardware Locations          | 11 |
| Embossment Profiles         | 12 |

## ESTATE

|                 |    |
|-----------------|----|
| 6'8" Doors      | 14 |
| 6'8" Sidelights | 25 |
| 7'0" Doors      | 31 |
| 8'0" Doors      | 34 |
| 8'0" Sidelights | 38 |

## SHAKER

|                |    |
|----------------|----|
| 6'8" Doors     | 43 |
| 6'8" Sidelight | 48 |
| 8'0" Doors     | 49 |
| 8'0" Sidelight | 54 |

## CONTEMPORARY

|            |    |
|------------|----|
| 6'8" Doors | 56 |
| 8'0" Doors | 64 |

## ESTATE FLUSH GLAZED

|                 |    |
|-----------------|----|
| 6'8" Doors      | 73 |
| 6'8" Sidelights | 77 |
| 8'0" Doors      | 79 |
| 8'0" Sidelights | 82 |

## SHAKER FLUSH GLAZED

|                 |    |
|-----------------|----|
| 6'8" Doors      | 85 |
| 6'8" Sidelights | 88 |
| 8'0" Doors      | 90 |
| 8'0" Sidelights | 92 |

## PRO OAK

|                 |     |
|-----------------|-----|
| 6'8" Doors      | 95  |
| 6'8" Sidelights | 100 |

## STEEL DOORS SPECIFICATIONS OVERVIEW

|                     |     |
|---------------------|-----|
| Features            |     |
| Wood Edge           | 102 |
| Steel Edge          | 103 |
| Edge Prep Details   | 104 |
| Hardware Locations  | 105 |
| Embossment Profiles | 106 |

## STEEL MARK & STEEL MARK PLUS

|                |     |
|----------------|-----|
| 6'8" Door      | 108 |
| 6'8" Sidelight | 120 |
| 7'0" Door      | 128 |
| 7'0" Sidelight | 132 |
| 8'0" Door      | 133 |
| 8'0" Sidelight | 138 |

## STEEL PRO

|            |     |
|------------|-----|
| 6'8" Doors | 140 |
|------------|-----|

## ADDITIONAL RESOURCES

|  |     |
|--|-----|
| Shaped Doorglass Cutout Dimensions       | 144 |
| Fire Rated Options                       | 146 |
| ADA Options                              | 148 |
| Fiberglass Door Accessories              |     |
| SDL Kits                                 | 149 |
| Dentil Shelves                           | 150 |
| Cleaning and Finishing Instructions      | 151 |
| Steel-Edge Adjustable Hinge Instructions | 153 |

# FIBERGLASS DOORS



# FEATURES

## FIBERGLASS DOORS

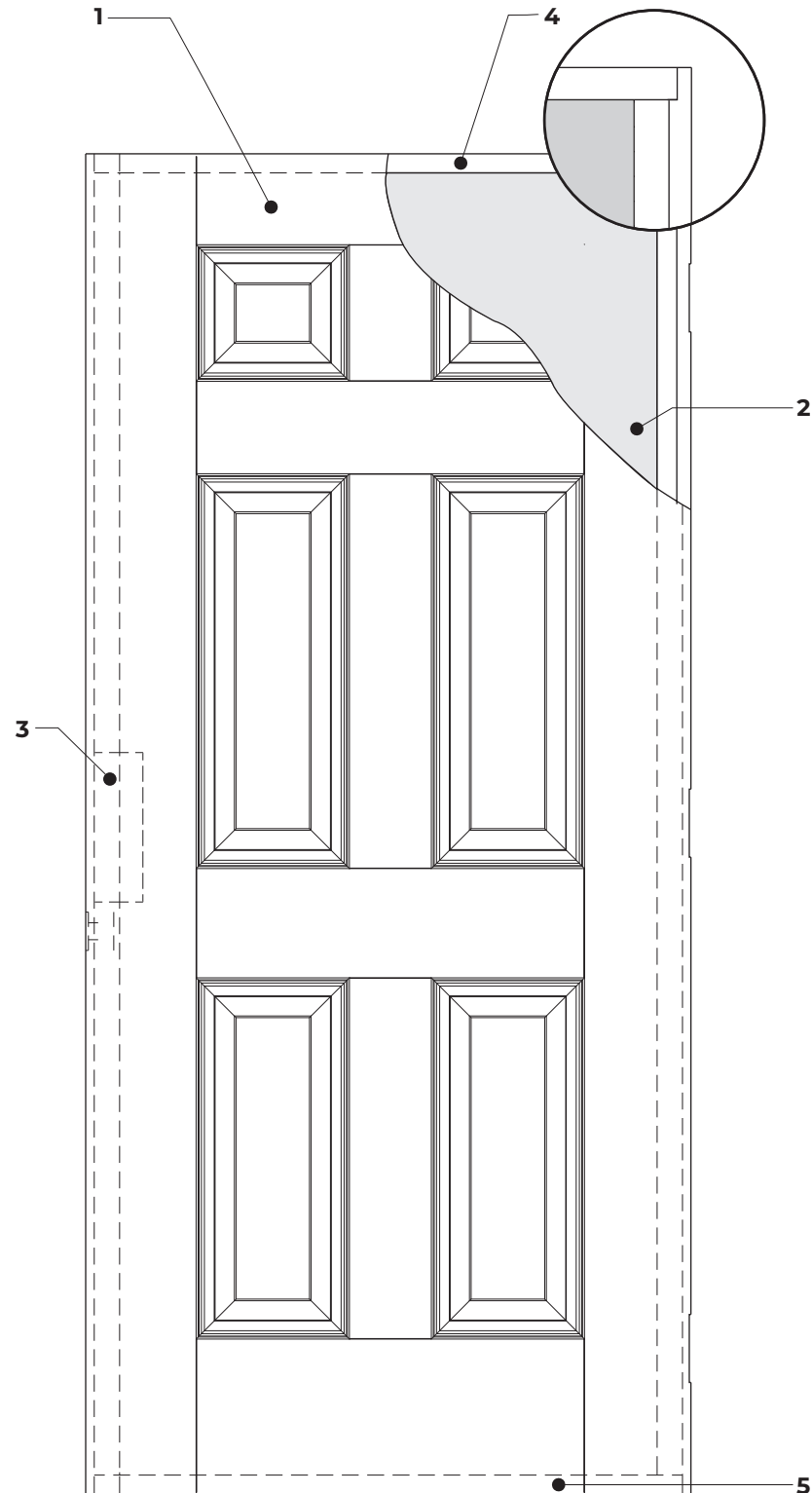

### 1.0 FIBERGLASS SKINS

- 1.1 Fine Grain | Tan
- 1.2 Rift Cut | Tan
- 1.3 Satin Smooth | White
- 1.4 Oak | White and Tan

### 2.0 FOAM CORE

- 2.1 Material: Polyurethane
- 2.2 Density: 2.2 lbs/cu.ft

### 3.0 SIDE STILES

- 3.1 Material: LVL w/Composite PVC cap
- 3.2 Pine lock block

### 4.0 TOP RAIL

- 4.1 Material: Composite

### 5.0 BOTTOM RAIL

- 5.1 Material: Composite
- 5.2 Kerfed for drive in sweep

### PACKAGING

- Paneled Doors per pallet: 27
- Flush Glazed Doors per pallet: 12
- Paneled Sidelights per pallet: 30
- Flush Glazed Sidelights per pallet: 12
- Banding: Metal (x2)
- Other: Corner boards (x4)
- Polyfilm wrap
- Product identification all four sides
- Four way access pallet

### STANDARD FEATURES

- Hinge prep
- Cylindrical lock locations
- Square edge design
- 1 3/4" door width

# BUILD TYPE OPTIONS

## FIBERGLASS DOORS

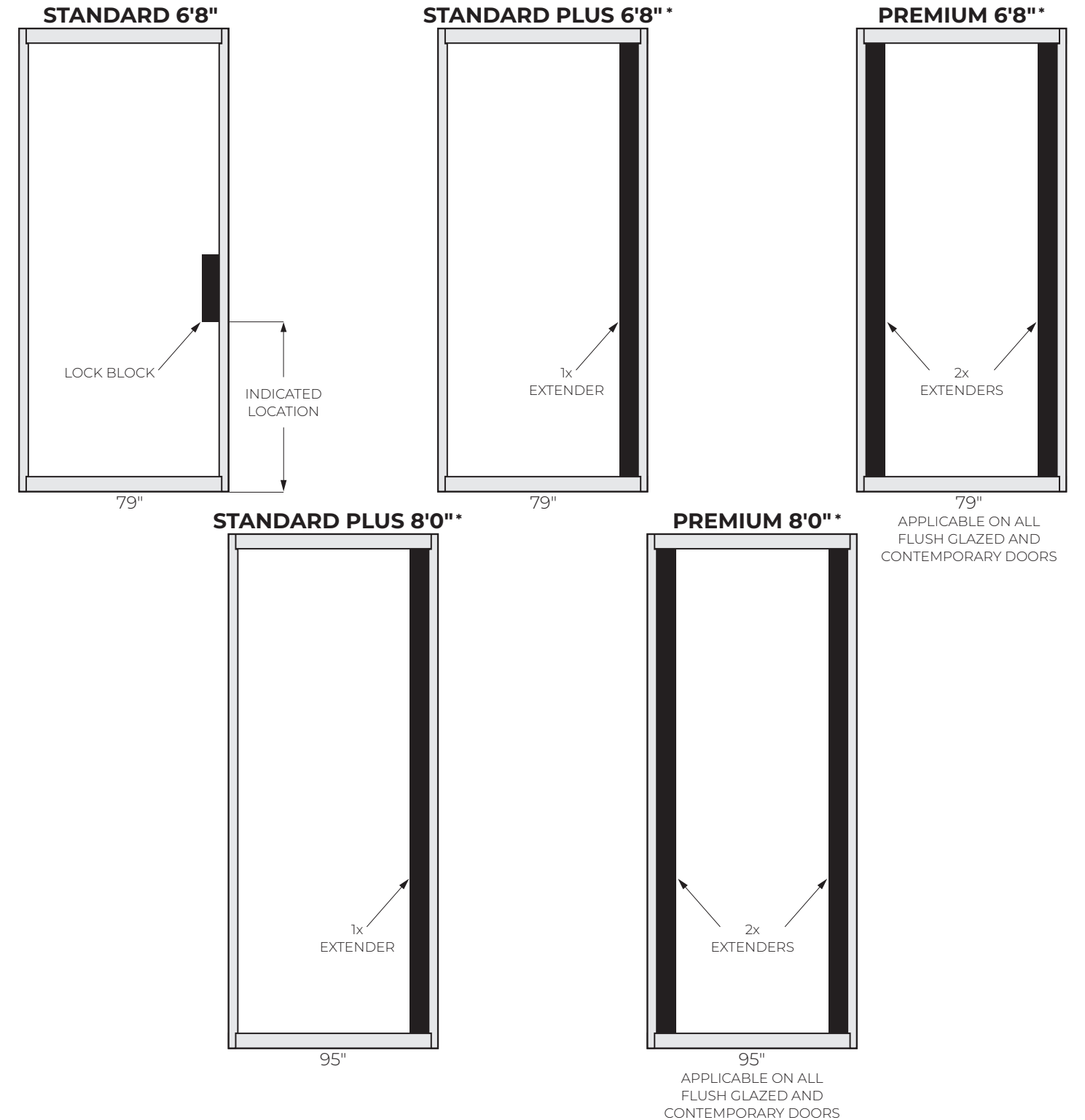

# REINFORCED BLOCKING OPTIONS

FOR PANIC PREP | 6'8", 7'0", AND 8'0" DOORS

**STANDARD 6'8" AND 7'0"**

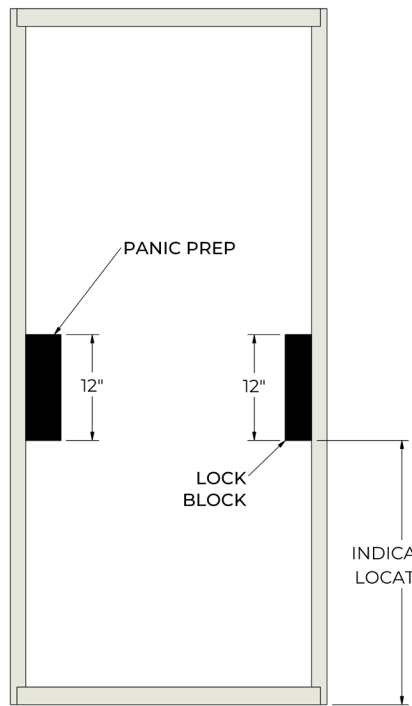

**STANDARD PLUS 6'8" AND 7'0"**

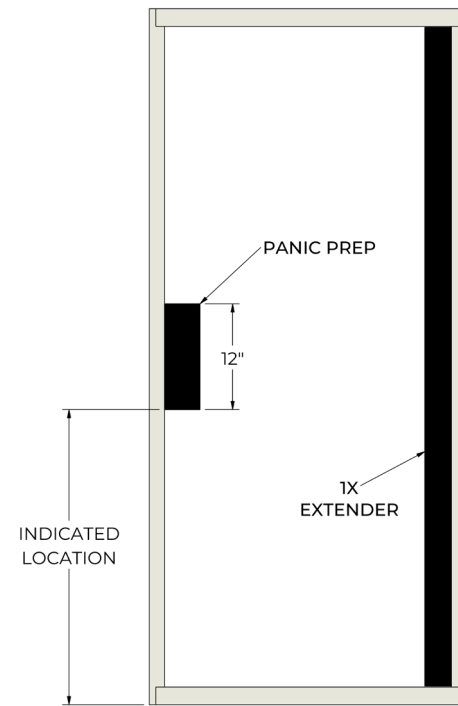

**PREMIUM 6'8" AND 7'0"**

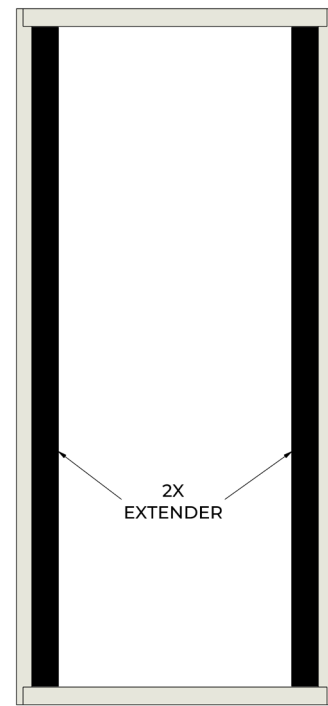

**STANDARD PLUS 8'0"**

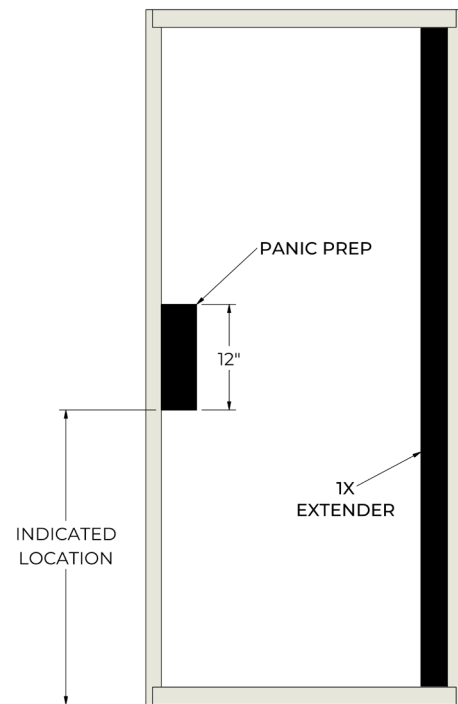

**PREMIUM 8'0"**

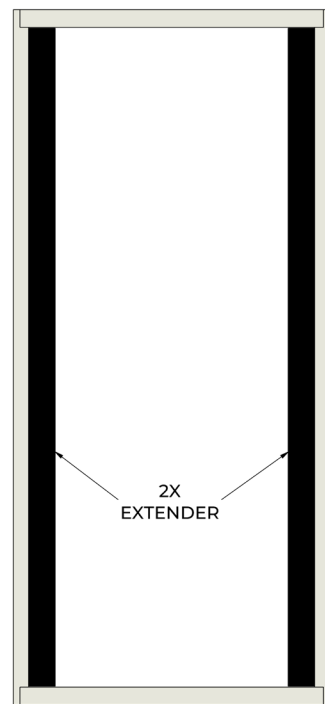

# REINFORCED BLOCKING OPTIONS

FOR CLOSER PREP | 6'8", 7'0", AND 8'0" DOORS

**STANDARD 6'8" AND 7'0"**

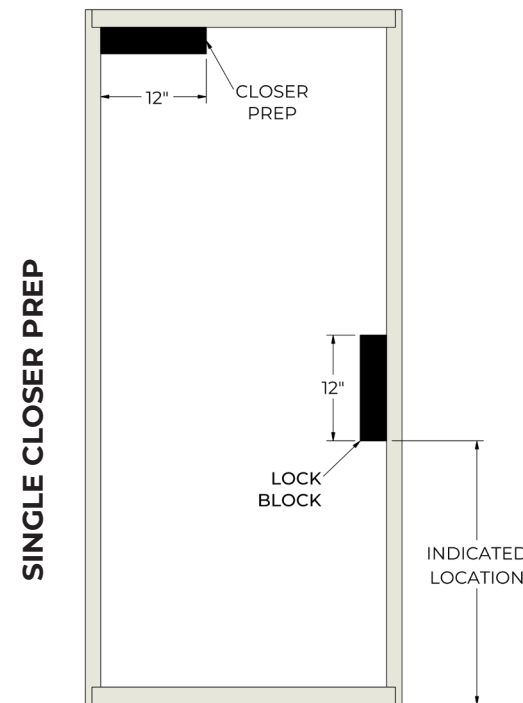

**STANDARD PLUS 6'8" 7'0" AND 8'0"**

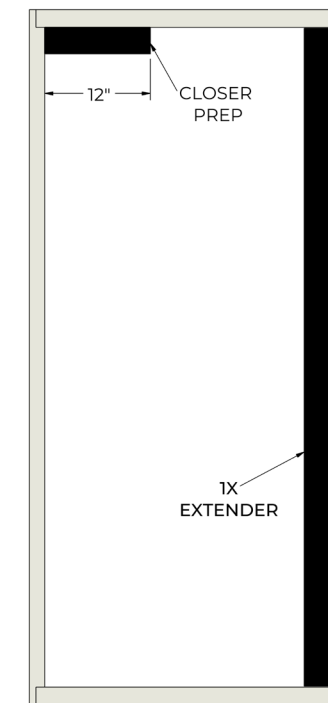

**PREMIUM 6'8" 7'0" AND 8'0"**

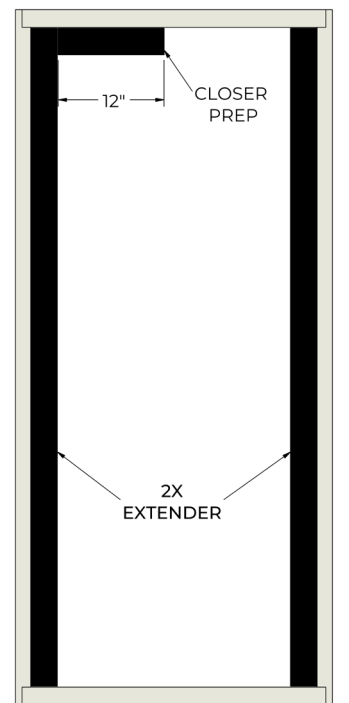

**STANDARD 6'8" AND 7'0"**

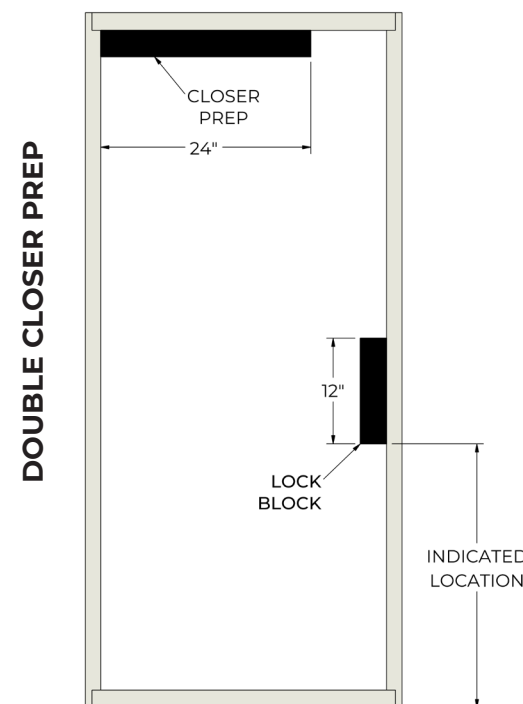

**STANDARD PLUS 6'8" 7'0" AND 8'0"**

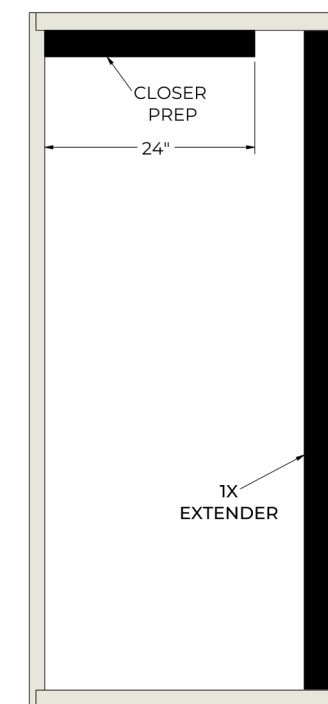

**PREMIUM 6'8" 7'0" AND 8'0"**

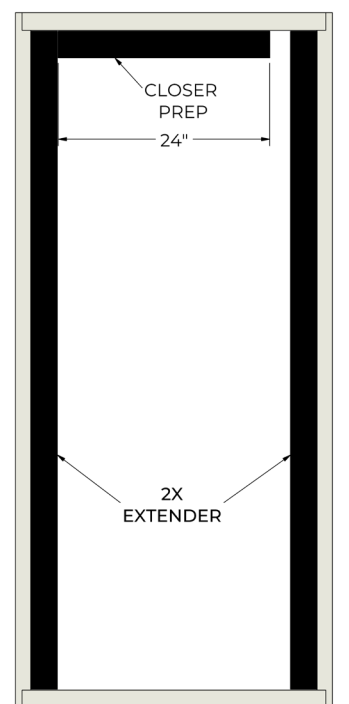

# EDGE PREP DETAILS

## FIBERGLASS DOORS-STANDARD BUILD

### LATCH PREP

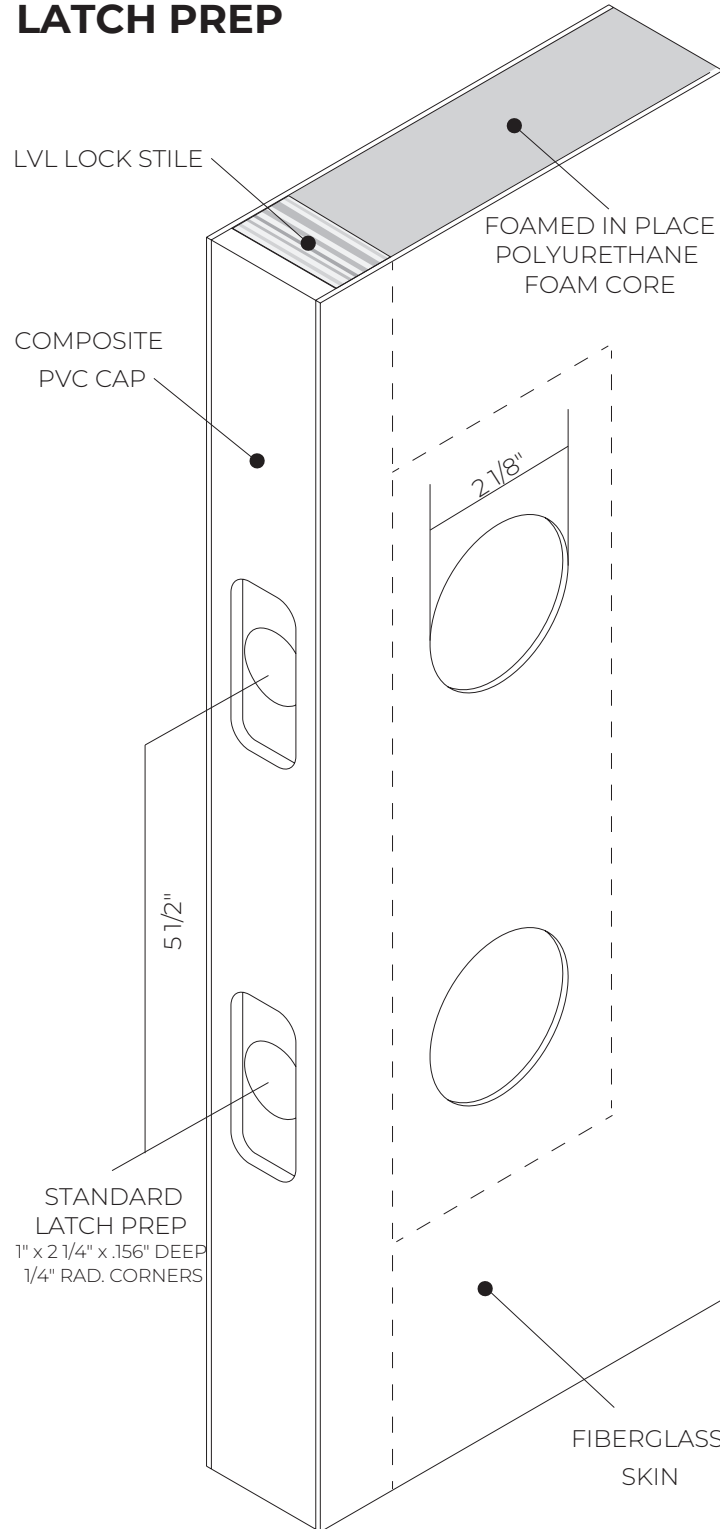

### HINGE PREP

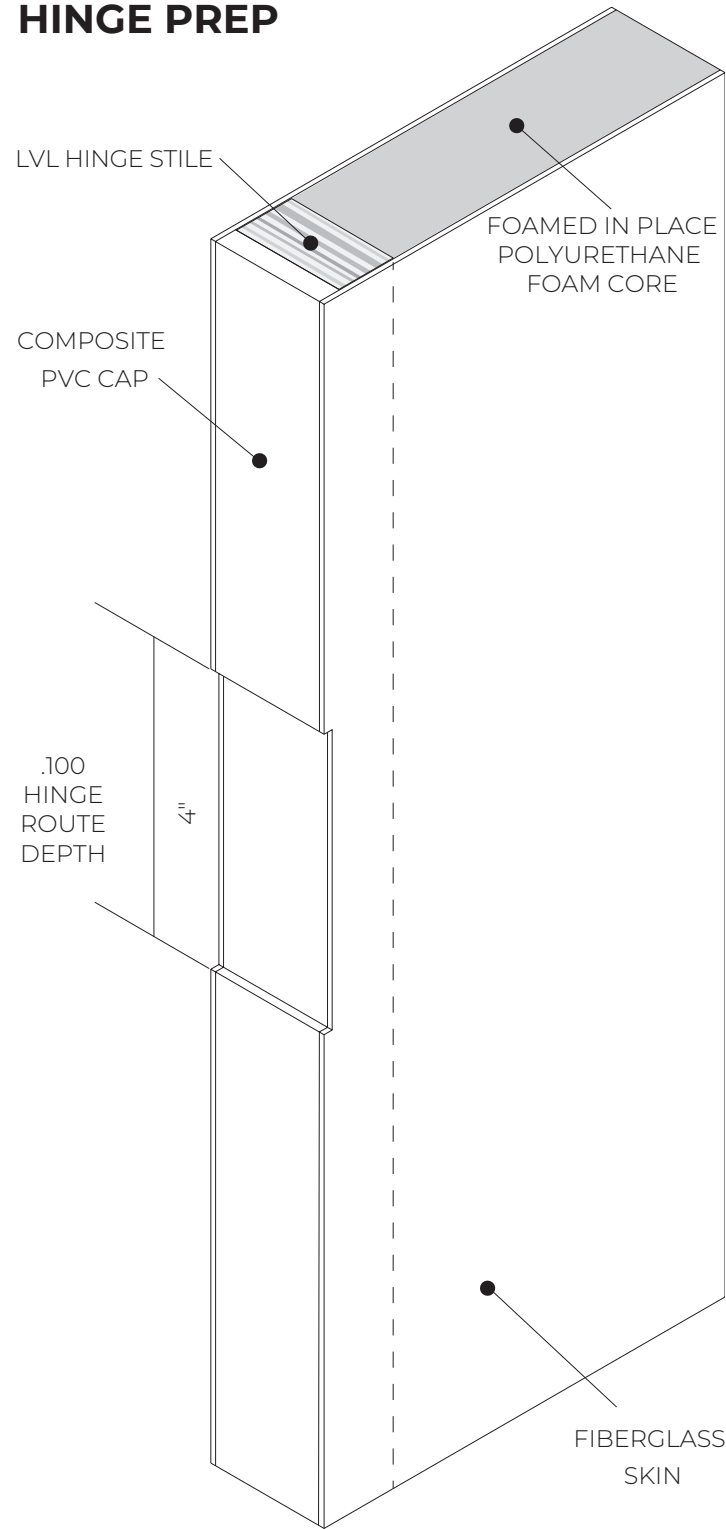

# EDGE PREP DETAILS

## FIBERGLASS DOORS-STANDARD PLUS BUILD

### LATCH PREP

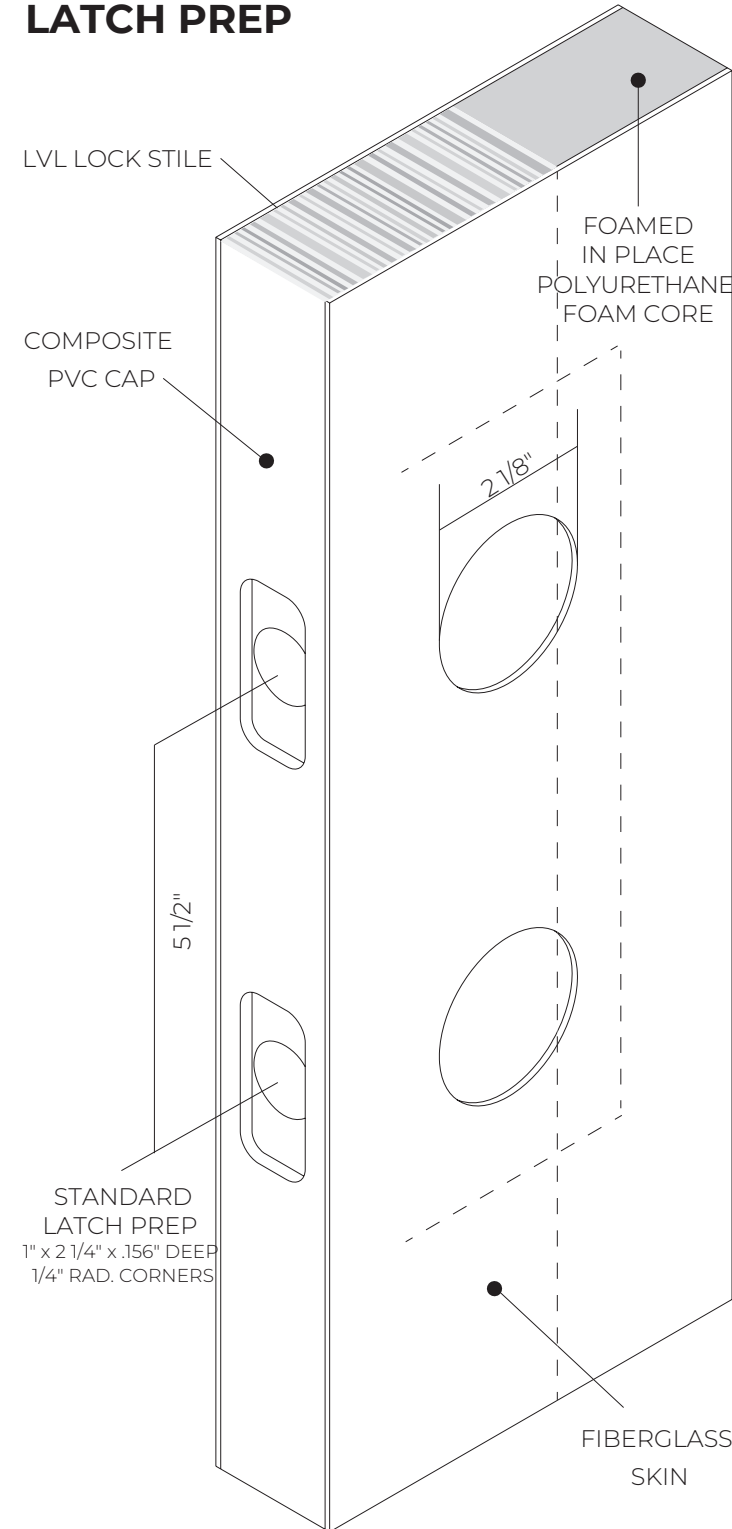

### HINGE PREP

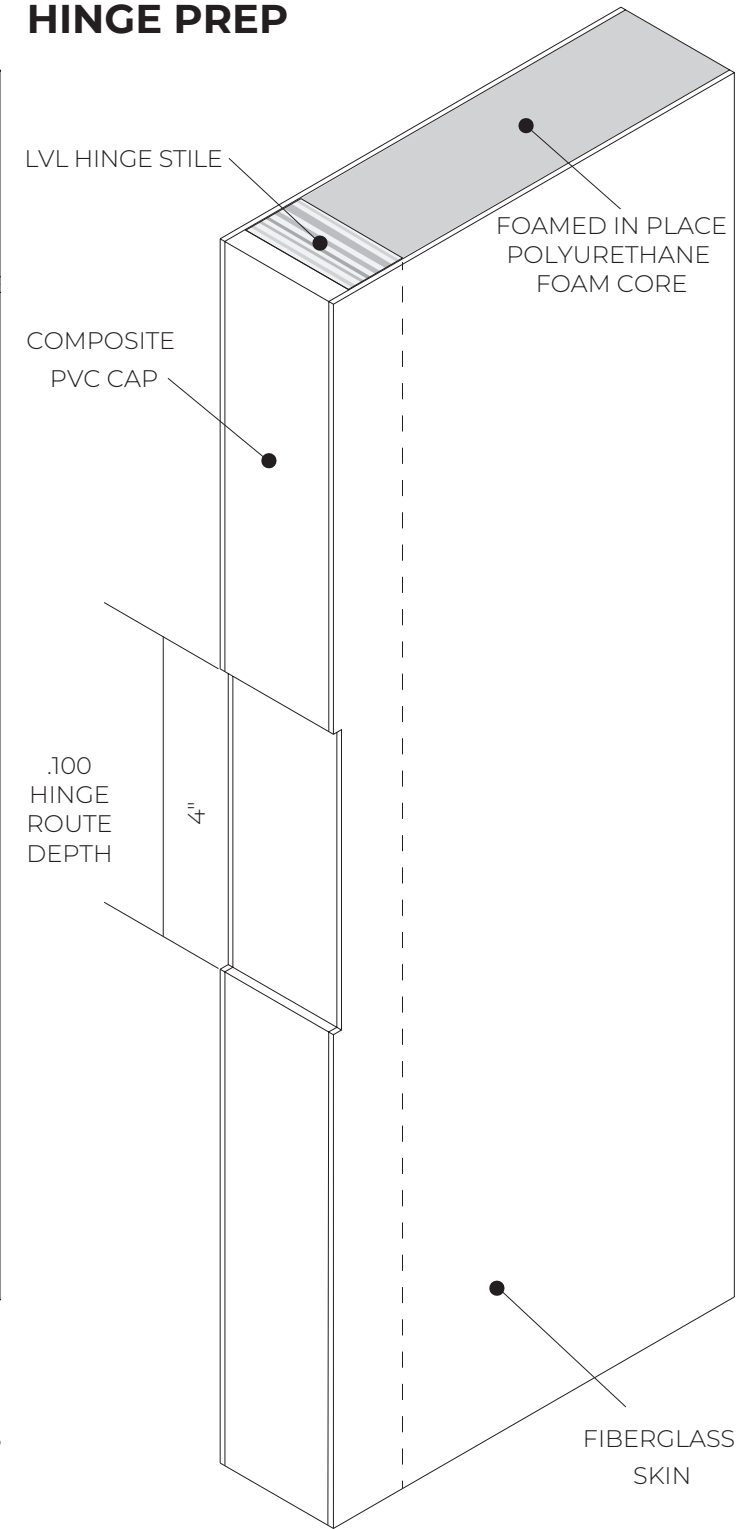

# EDGE PREP DETAILS

FIBERGLASS DOORS-PREMIUM BUILD

## LATCH PREP

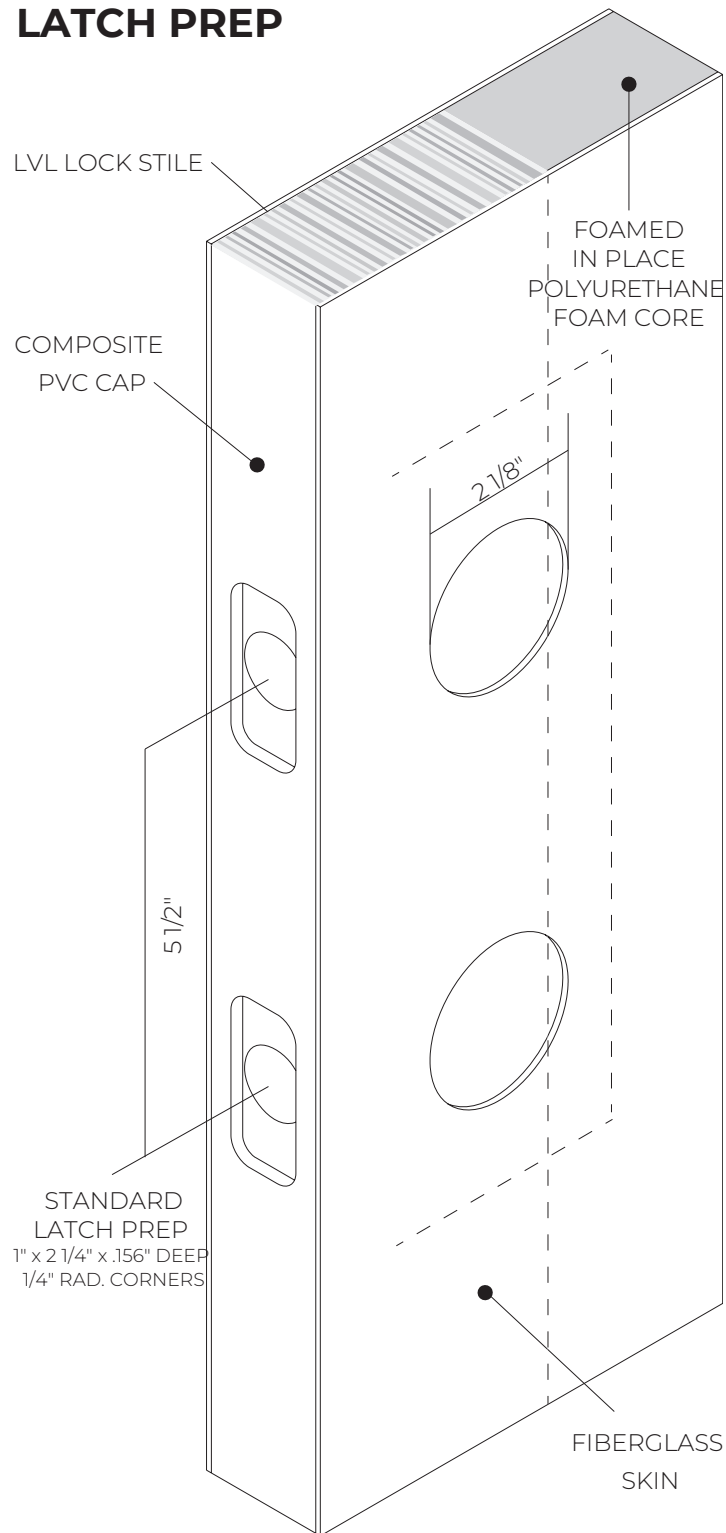

## HINGE PREP

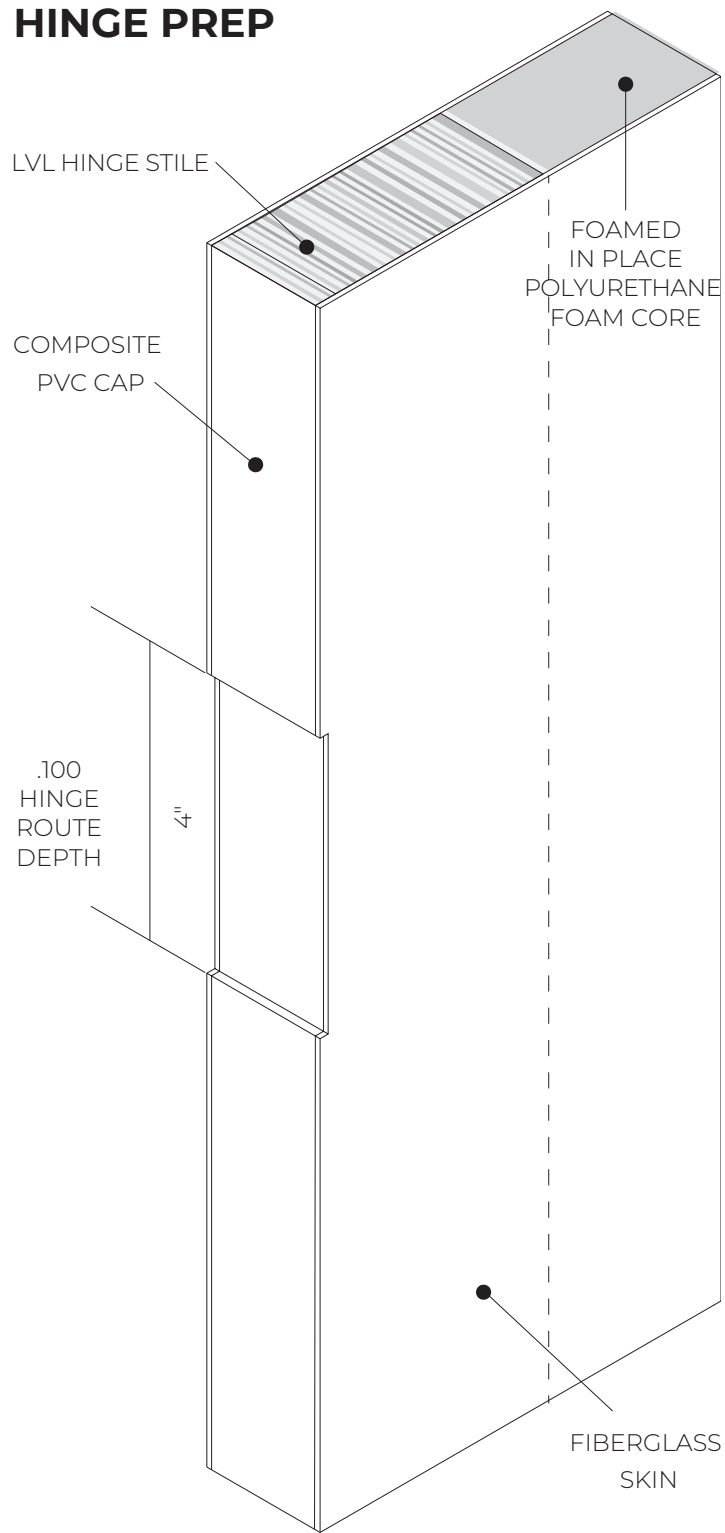

# HARDWARE LOCATIONS

FOR SMOOTH AND TEXTURED FIBERGLASS DOORS

## 6'8" LOCATIONS

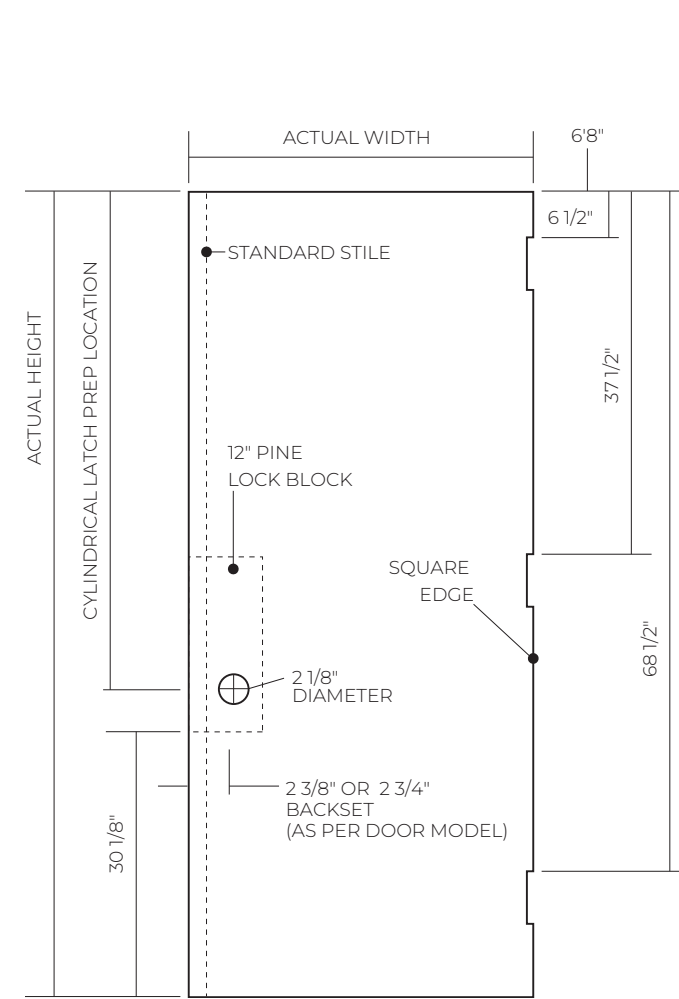

| DOOR HEIGHT |        |                                 |
|-------------|--------|---------------------------------|
| NOMINAL     | ACTUAL | CYLINDRICAL LATCH PREP LOCATION |
| 6-8         | 79"    | 45 7/8"                         |

## 8'0" LOCATIONS

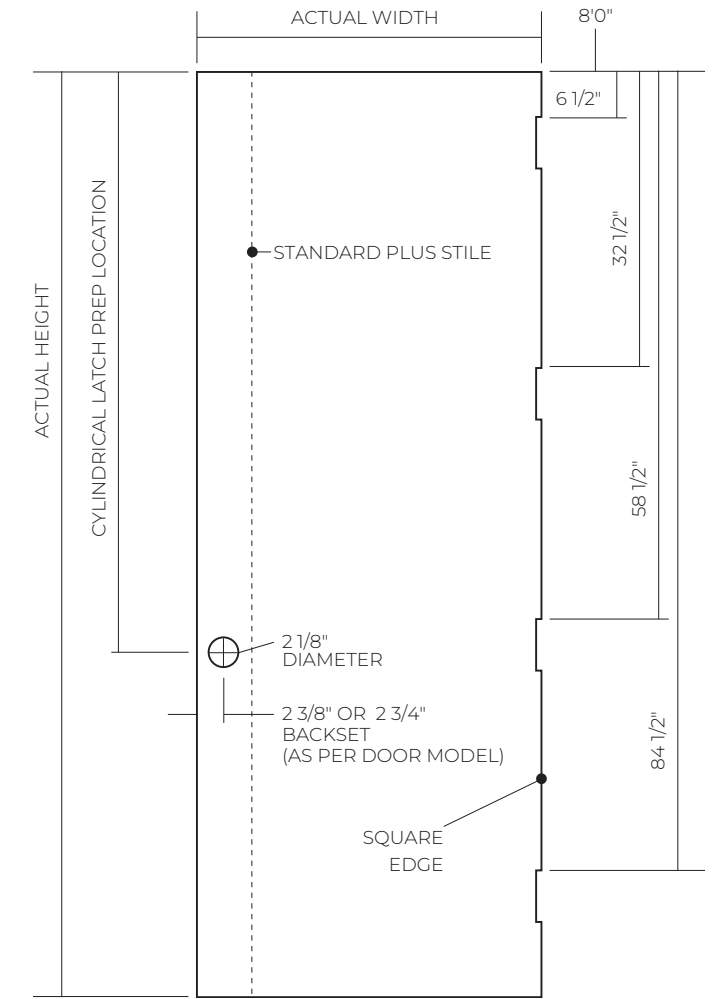

| DOOR HEIGHT |        |                                 |
|-------------|--------|---------------------------------|
| NOMINAL     | ACTUAL | CYLINDRICAL LATCH PREP LOCATION |
| 8-0         | 95"    | 59"                             |

# EMBOSSMENT PROFILES

FIBERGLASS DOORS AND SIDELIGHTS



**EDGE** (ESTATE PANEL DOORS)

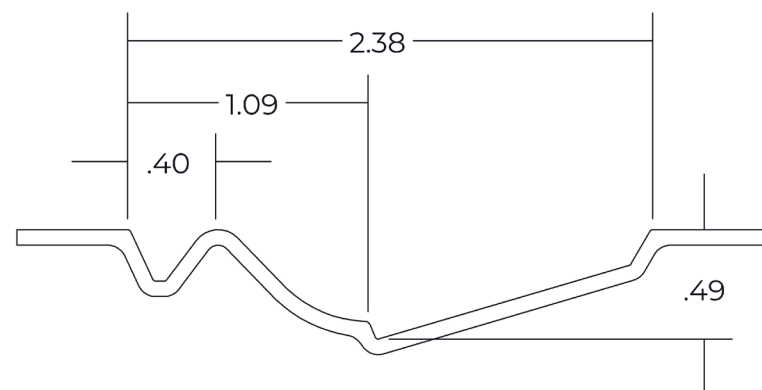

**EDGE PLUS** (ESTATE PLANK DOORS)

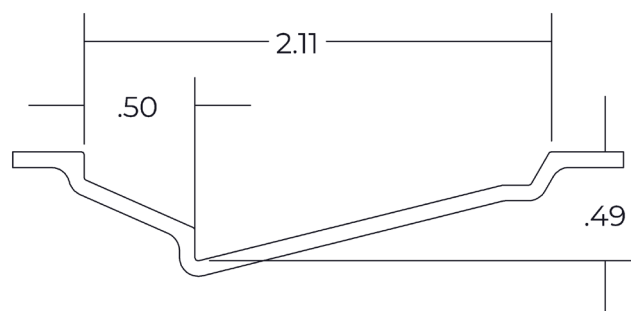

**SHAKER** (SHAKER PANEL DOORS)

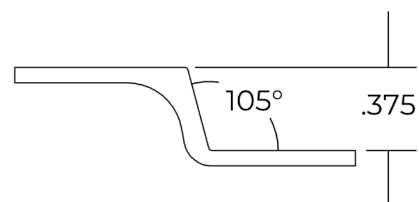

**CLASSIC** (PRO OAK DOORS)

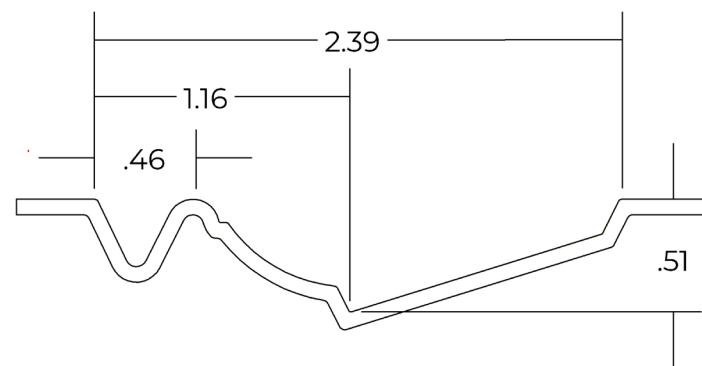

# ESTATE

FIBERGLASS DOORS AND SIDELIGHTS



# 6'8" FLUSH FIBERGLASS DOOR

FINE GRAIN | TAN

RIFT CUT | TAN

SATIN SMOOTH | WHITE

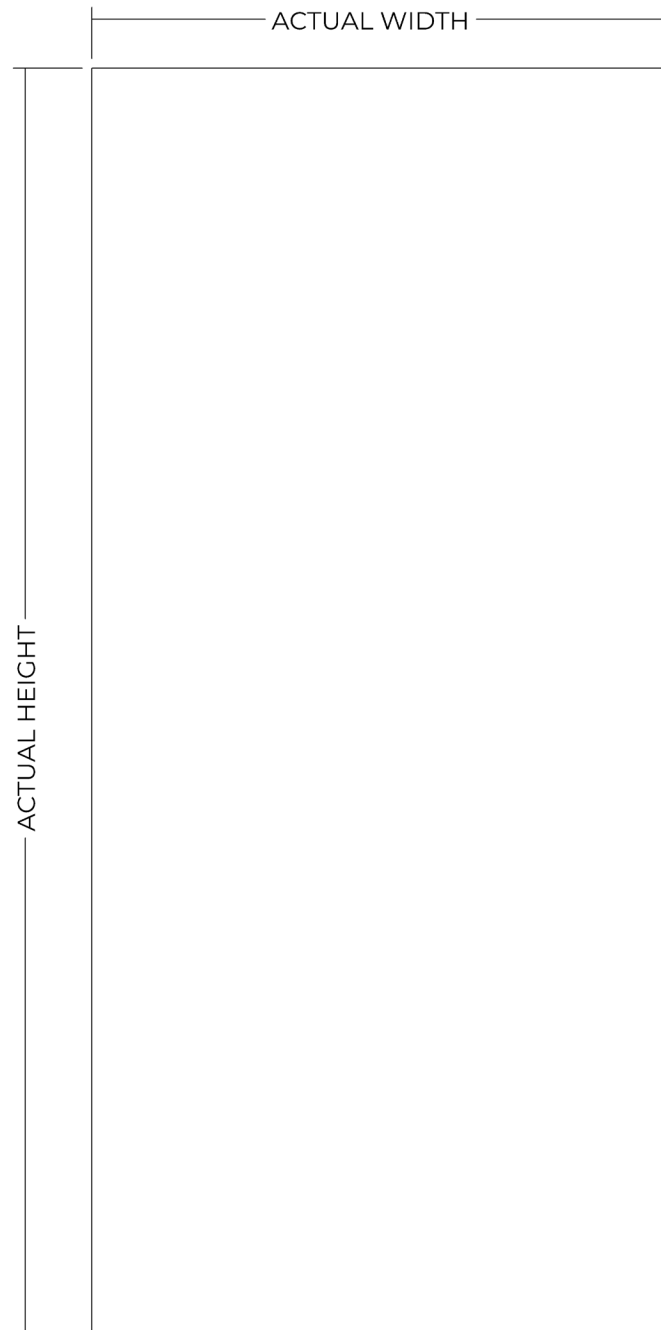

### DOOR WIDTH

| NOMINAL | ACTUAL  |
|---------|---------|
| 2-6     | 29 3/4" |
| 2-8     | 31 3/4" |
| 2-10    | 33 3/4" |
| 3-0     | 35 3/4" |
| 3-6     | 41 3/4" |

### DOOR HEIGHT

| NOMINAL | ACTUAL |
|---------|--------|
| 6-8     | 79"    |

### GLASS OPTIONS

| SIZE           | CUTOUT       |
|----------------|--------------|
| 7 x 64         | 8 x 65       |
| 8 x 64         | 9 x 65       |
| 11 x 5 3L      | 12 x 6 3L    |
| 12 x 12 3L     | 13 x 13 3L   |
| 14 x 64        | 15 x 65      |
| 20 x 56 oval** | 21 x 57 oval |
| 22 x 3.5 5L    | 13 x 4.5 5L  |
| 22 x 10 3L     | 23 x 11 3L   |
| 22 x 17 3L     | 23 x 18      |
| 22 x 36        | 23 x 37      |
| 22 x 60*       | 23 x 61      |
| 22 x 64        | 23 x 65      |
| 22 x 64 RT**   | 23 x 65 RT   |

\*\*Refer to page 144-145 for non-rectangular cutout dimensions



# 6'8" 6 PANEL FIBERGLASS DOOR

RIFT CUT | TAN

SATIN SMOOTH | WHITE

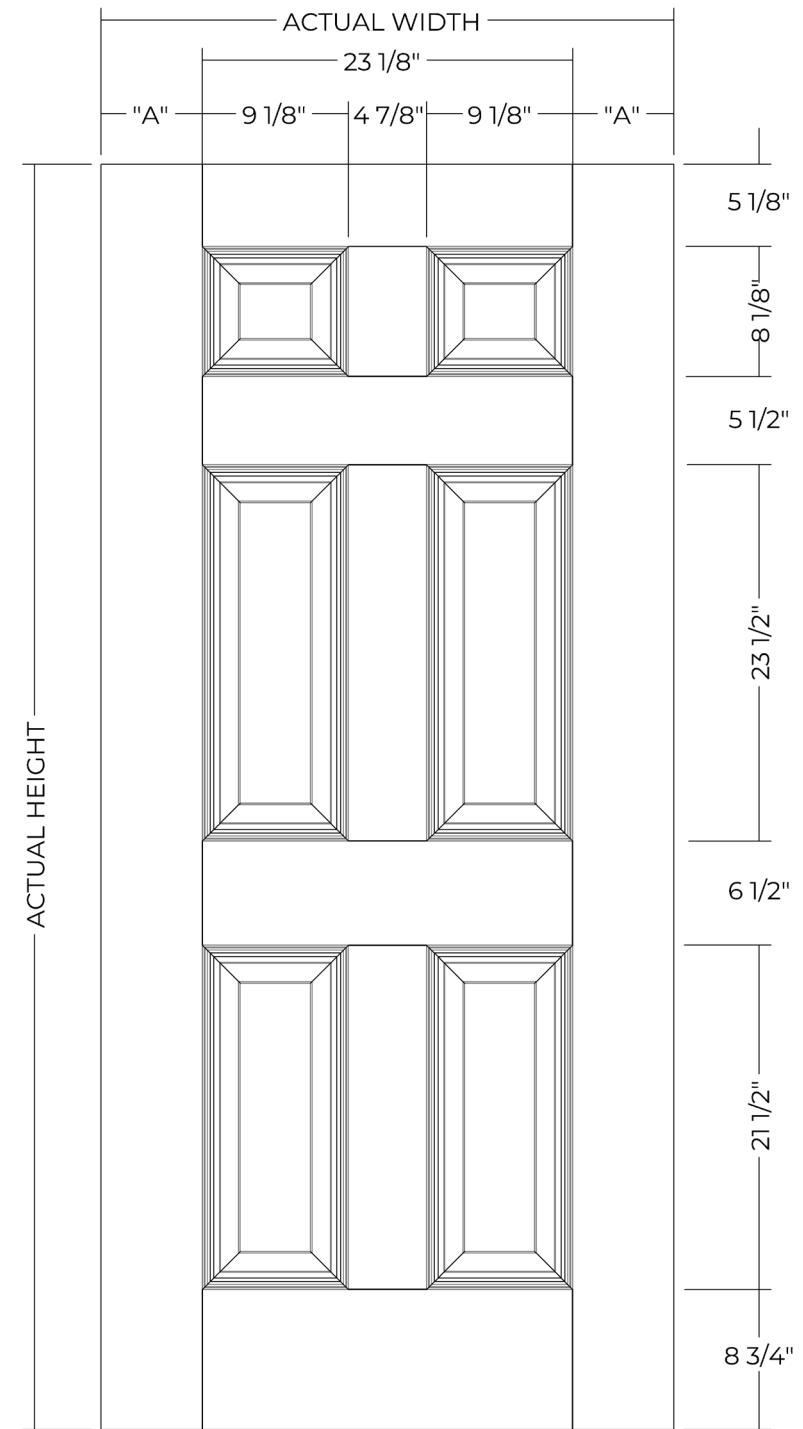

### DOOR WIDTH

| NOMINAL | ACTUAL  | "A"     |
|---------|---------|---------|
| 2-8     | 31 3/4" | 4 5/16" |
| 2-10    | 33 3/4" | 5 5/16" |
| 3-0     | 35 3/4" | 6 5/16" |

### DOOR HEIGHT

| NOMINAL | ACTUAL |
|---------|--------|
| 6-8     | 79"    |

### GLASS OPTIONS

| SIZE    | CUTOUT  |
|---------|---------|
| 22 x 10 | 23 x 11 |
| 22 x 36 | 23 x 37 |
| 22 x 64 | 23 x 65 |

Note: The dimension shown from bottom of door to bottom of embossment is 1/4" larger on 79 1/4" and 95 1/4" doors.

ESTATE

ESTATE



# 6'8" 6 PANEL NARROW

FIBERGLASS DOOR

SATIN SMOOTH | WHITE

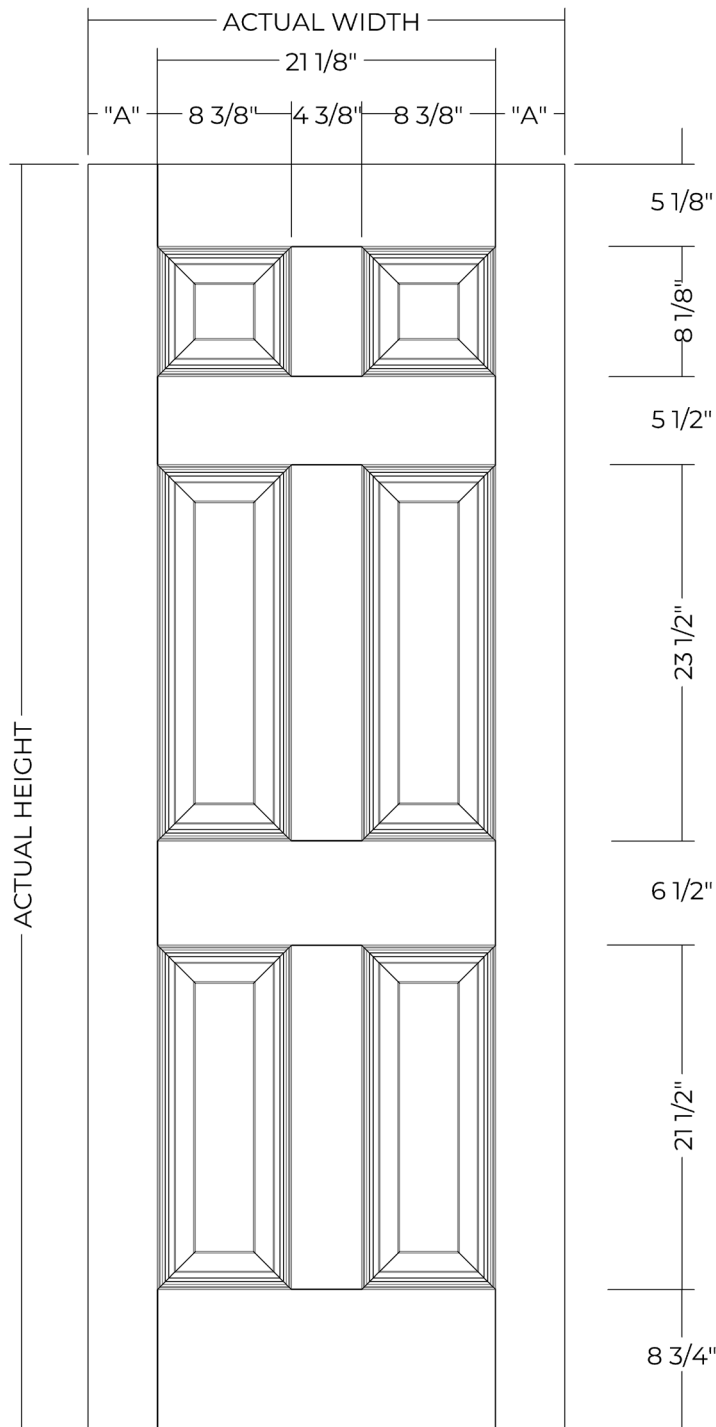

### DOOR WIDTH

| NOMINAL | ACTUAL  | "A"     |
|---------|---------|---------|
| 2-6*    | 29 3/4" | 4 5/16" |

### DOOR HEIGHT

| NOMINAL | ACTUAL |
|---------|--------|
| 6-8     | 79"    |

### GLASS OPTIONS

| SIZE    | CUTOUT  |
|---------|---------|
| 20 x 36 | 21 x 37 |
| 20 x 64 | 21 x 65 |

\* 2 3/8" Backset Only

Note: The dimension shown from bottom of door to bottom of embossment is 1/4" larger on 79 1/4" and 95 1/4" doors.

# 6'8" ADA 6 PANEL

FIBERGLASS DOOR

SATIN SMOOTH | WHITE

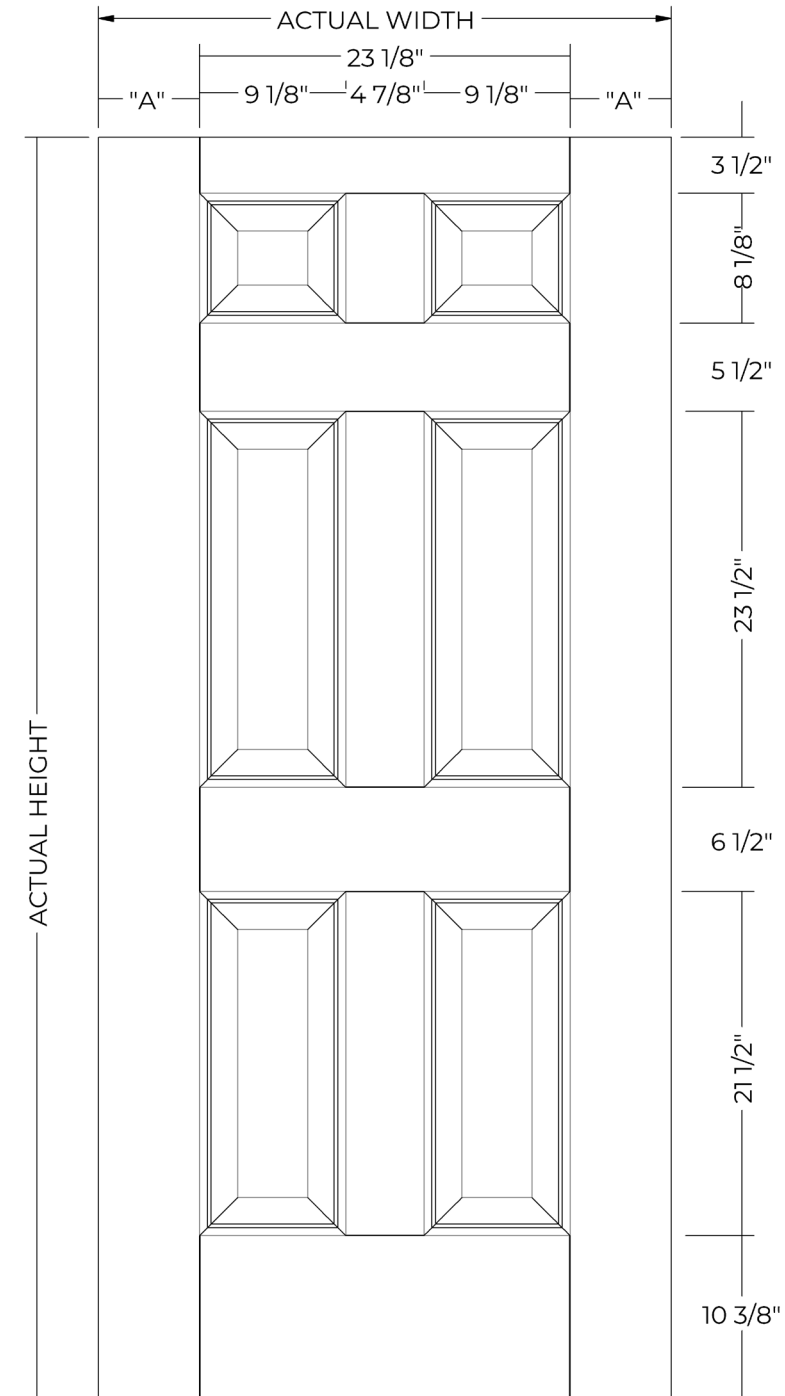

### DOOR WIDTH

| NOMINAL | ACTUAL  | "A"     |
|---------|---------|---------|
| 2-8     | 31 3/4" | 4 5/16" |
| 2-10    | 33 3/4" | 5 5/16" |
| 3-0     | 35 3/4" | 6 5/16" |

### DOOR HEIGHT

| NOMINAL | ACTUAL |
|---------|--------|
| 6-8     | 79"    |

### GLASS OPTIONS

| SIZE    | CUTOUT  |
|---------|---------|
| 22 x 36 | 23 x 37 |
| 22 x 64 | 23 x 65 |

 ADA COMPLIANT

Note: The dimension shown from bottom of door to bottom of embossment is 1/4" larger on 79 1/4" and 95 1/4" doors.

ESTATE

ESTATE

# 6'8" 4 PANEL BLANK TOP

FIBERGLASS DOOR

SATIN SMOOTH | WHITE

### DOOR WIDTH

| NOMINAL | ACTUAL  | "A"     |
|---------|---------|---------|
| 2-8     | 31 3/4" | 4 5/16" |
| 2-10    | 33 3/4" | 5 5/16" |
| 3-0     | 35 3/4" | 6 5/16" |

### DOOR HEIGHT

| NOMINAL | ACTUAL |
|---------|--------|
| 6-8     | 79"    |

### GLASS OPTIONS

| SIZE         | CUTOUT      |
|--------------|-------------|
| 9 X 21 SUN** | 10 x 22 SUN |
| 22 x 10      | 23 x 11     |
| 22 x 10 AT** | 23 x 11 AT  |
| 22 x 36      | 23 x 37     |
| 22 x 36 RT** | 23 x 37 RT  |
| 22 x 38 AT** | 23 x 39 AT  |
| 22 x 64      | 23 x 65     |
| 22 x 64 RT*  | 23 x 65 RT  |

\*\*Refer to page 144-145 for non-rectangular cutout dimensions

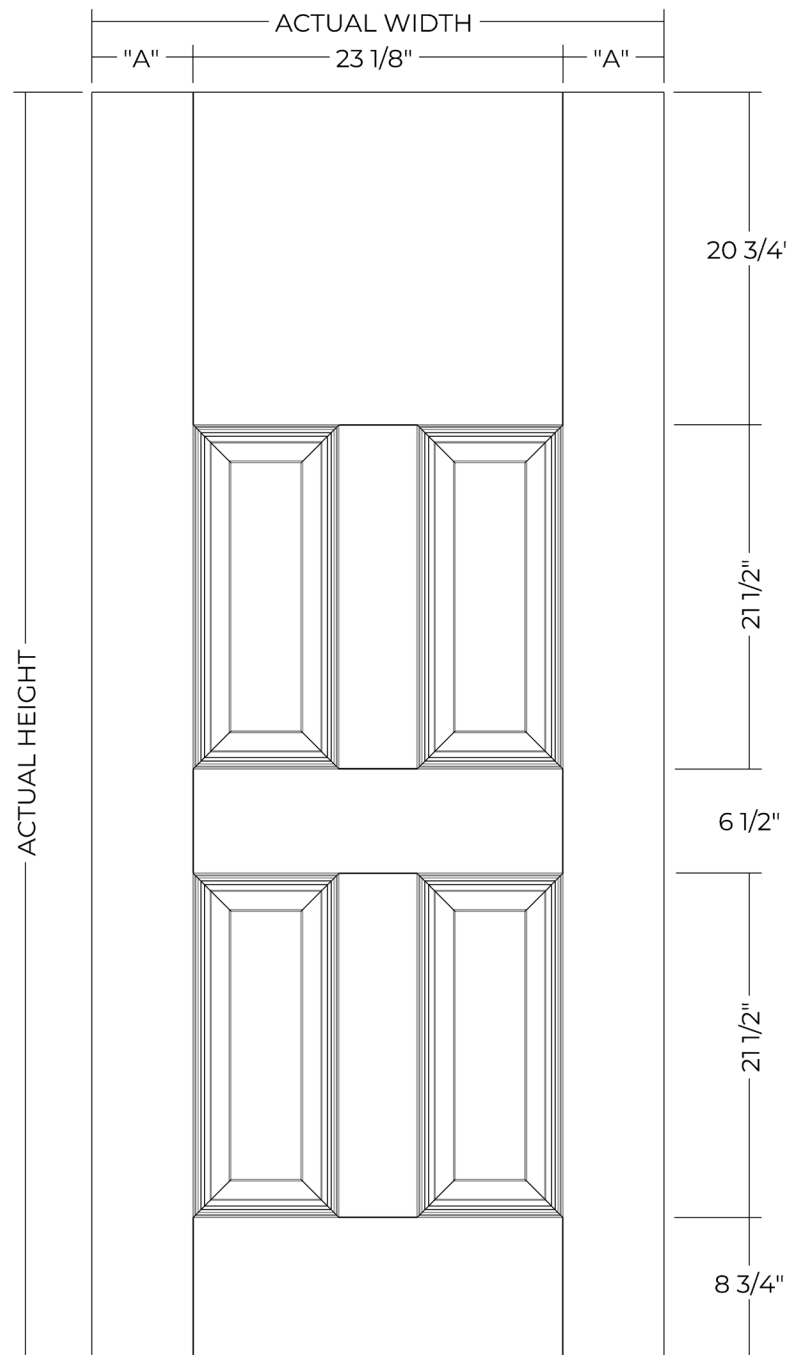

Note: The dimension shown from bottom of door to bottom of embossment is 1/4" larger on 79 1/4" and 95 1/4" doors.

# 6'8" 2 PANEL 3/4 TOP

FIBERGLASS DOOR

RIFT CUT | TAN | SATIN SMOOTH | WHITE

### DOOR WIDTH

| NOMINAL | ACTUAL  | "A"     |
|---------|---------|---------|
| 2-8     | 31 3/4" | 4 5/16" |
| 2-10    | 33 3/4" | 5 5/16" |
| 3-0     | 35 3/4" | 6 5/16" |

### DOOR HEIGHT

| NOMINAL | ACTUAL |
|---------|--------|
| 6-8     | 79"    |

### GLASS OPTIONS

| SIZE           | CUTOUT       |
|----------------|--------------|
| 15 x 39 oval** | 16 x 40 oval |
| 22 x 48        | 23 x 49      |
| 22 x 64        | 23 x 65      |

\*\*Refer to page 144-145 for non-rectangular cutout dimensions

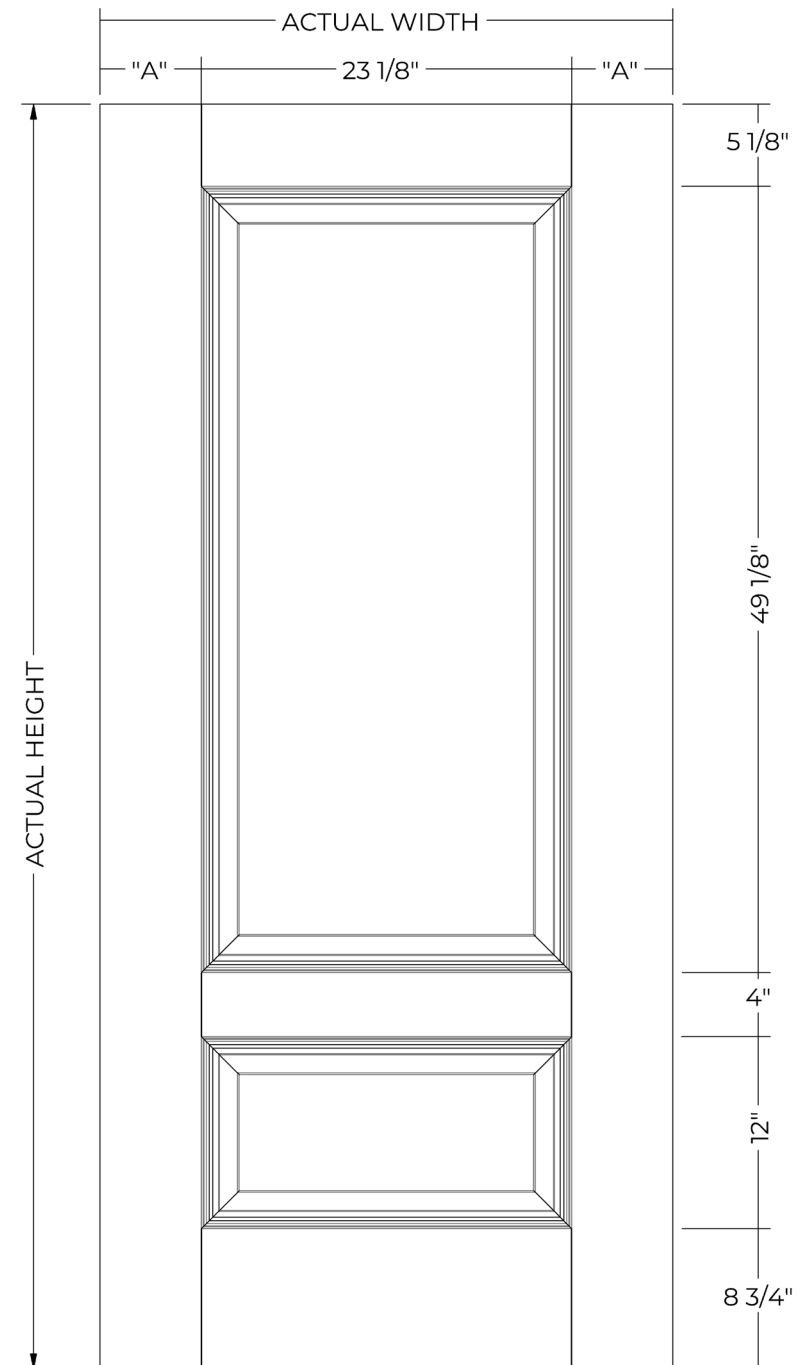

Note: The dimension shown from bottom of door to bottom of embossment is 1/4" larger on 79 1/4" and 95 1/4" doors.

ESTATE

ESTATE

# 6'8" 3 PANEL 3/4 TOP

FIBERGLASS DOOR

SATIN SMOOTH | WHITE

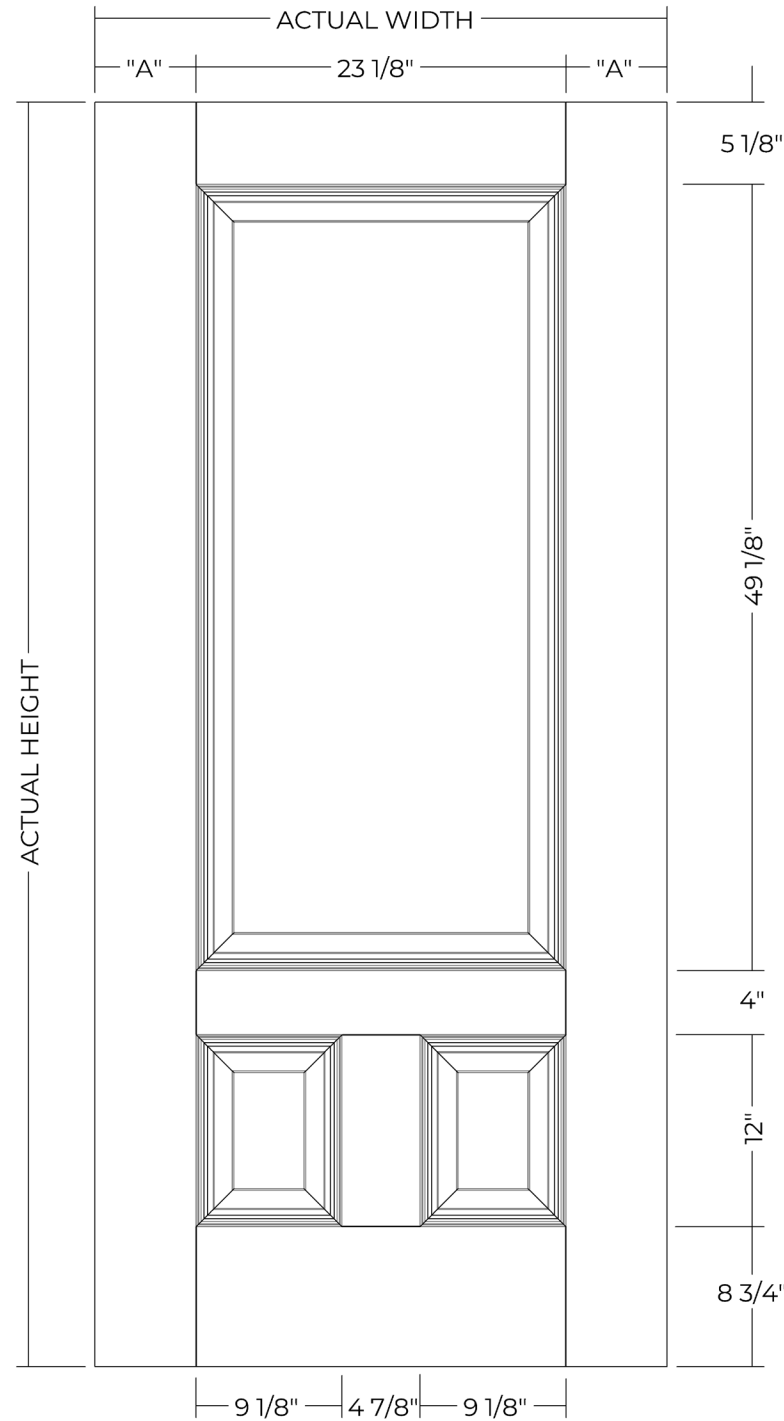

| DOOR WIDTH |         |         |
|------------|---------|---------|
| NOMINAL    | ACTUAL  | "A"     |
| 2-8        | 31 3/4" | 4 5/16" |
| 2-10       | 33 3/4" | 5 5/16" |
| 3-0        | 35 3/4" | 6 5/16" |

| DOOR HEIGHT |        |
|-------------|--------|
| NOMINAL     | ACTUAL |
| 6-8         | 79"    |

| GLASS OPTIONS  |              |
|----------------|--------------|
| SIZE           | CUTOUT       |
| 15 x 39 oval** | 16 x 40 oval |
| 22 x 48        | 23 x 49      |
| 22 x 64        | 23 x 65      |

\*\*Refer to page 144-145 for non-rectangular cutout dimensions

Note: The dimension shown from bottom of door to bottom of embossment is 1/4" larger on 79 1/4" and 95 1/4" doors.

# 6'8" 2 PANEL SQUARE

FIBERGLASS DOOR

RIFT CUT | TAN | SATIN SMOOTH | WHITE

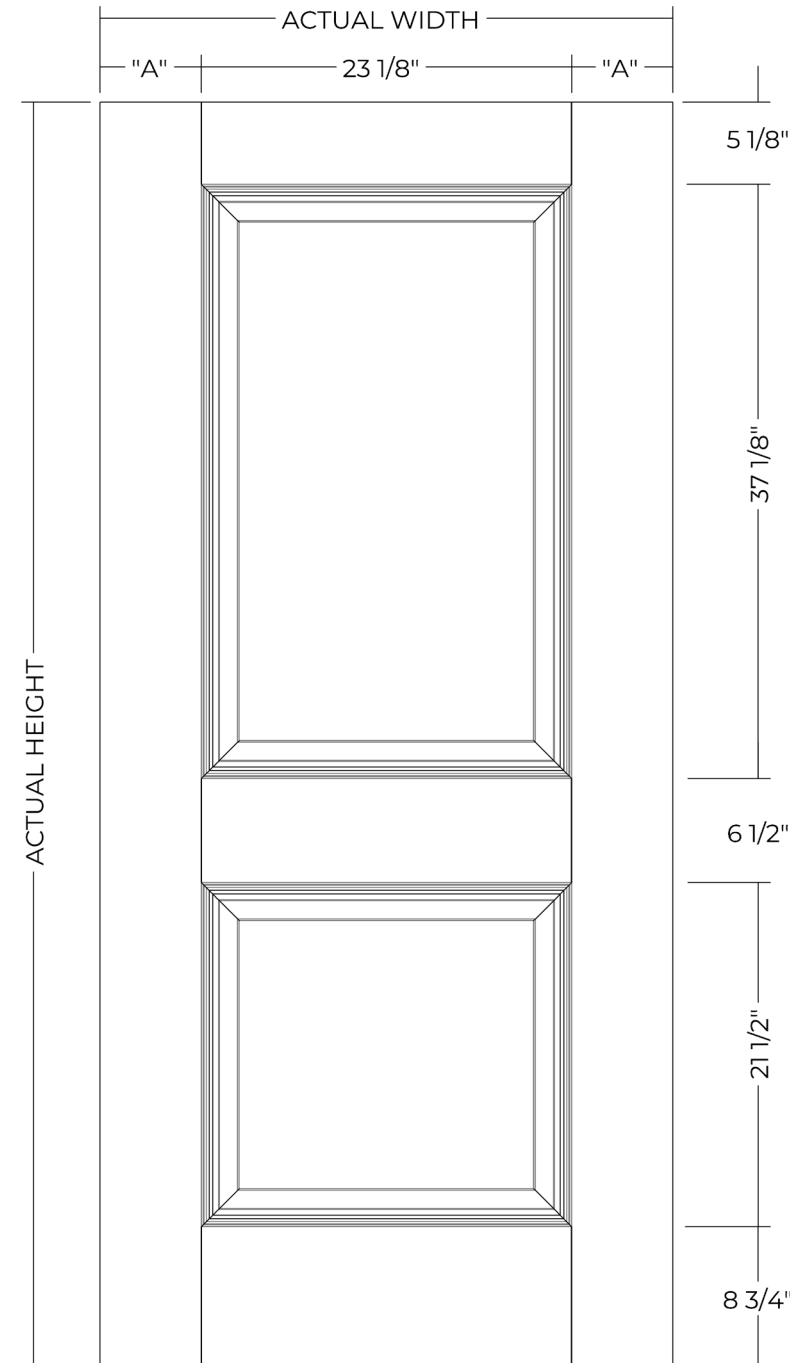

| DOOR WIDTH |         |         |
|------------|---------|---------|
| NOMINAL    | ACTUAL  | "A"     |
| 2-8        | 31 3/4" | 4 5/16" |
| 2-10       | 33 3/4" | 5 5/16" |
| 3-0        | 35 3/4" | 6 5/16" |

| DOOR HEIGHT |        |
|-------------|--------|
| NOMINAL     | ACTUAL |
| 6-8         | 79"    |

| GLASS OPTIONS |         |
|---------------|---------|
| SIZE          | CUTOUT  |
| 22 x 36       | 23 x 37 |
| 22 x 64       | 23 x 65 |

Note: The dimension shown from bottom of door to bottom of embossment is 1/4" larger on 79 1/4" and 95 1/4" doors.

ESTATE

ESTATE

# 6'8" ADA 2 PANEL SQUARE

FIBERGLASS DOOR

SATIN SMOOTH | WHITE

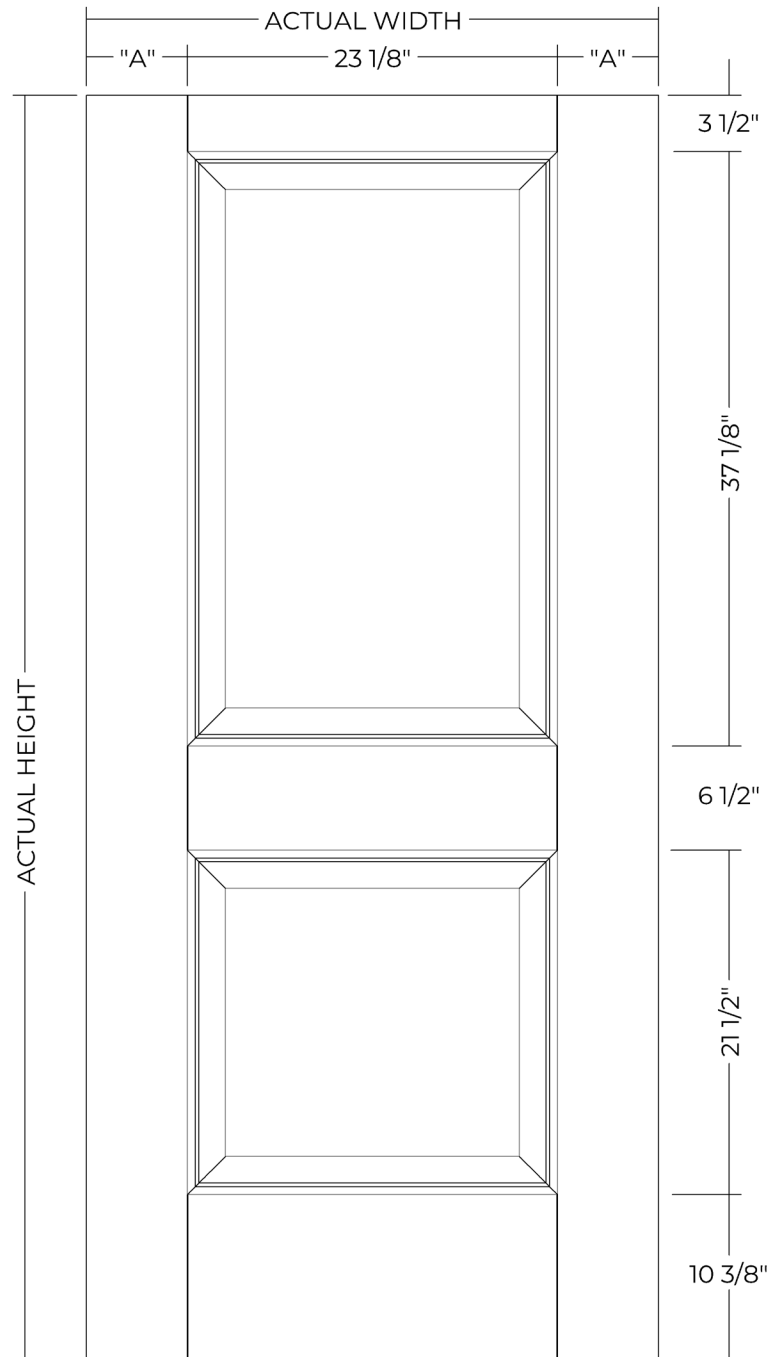

| DOOR WIDTH |         |         |
|------------|---------|---------|
| NOMINAL    | ACTUAL  | "A"     |
| 2-8        | 31 3/4" | 4 5/16" |
| 2-10       | 33 3/4" | 5 5/16" |
| 3-0        | 35 3/4" | 6 5/16" |

| DOOR HEIGHT |        |
|-------------|--------|
| NOMINAL     | ACTUAL |
| 6-8         | 79"    |

| GLASS OPTIONS |         |
|---------------|---------|
| SIZE          | CUTOUT  |
| 22 x 36*      | 23 x 37 |
| 22 x 64*      | 23 x 65 |



Note: The dimension shown from bottom of door to bottom of embossment is 1/4" larger on 79 1/4" and 95 1/4" doors.

# 6'8" 2 PANEL CAMBER

FIBERGLASS DOOR

SATIN SMOOTH | WHITE

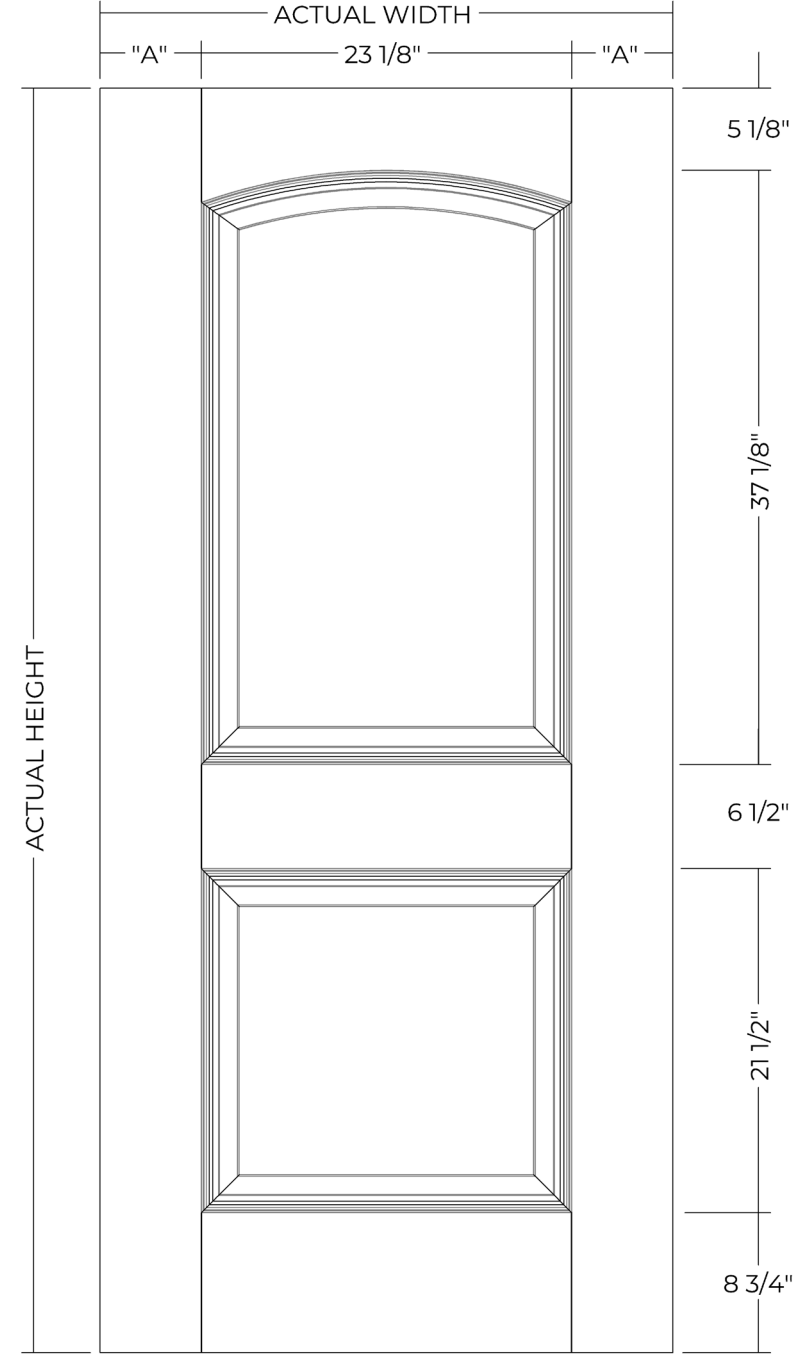

| DOOR WIDTH |         |         |
|------------|---------|---------|
| NOMINAL    | ACTUAL  | "A"     |
| 2-8        | 31 3/4" | 4 5/16" |
| 2-10       | 33 3/4" | 5 5/16" |
| 3-0        | 35 3/4" | 6 5/16" |

| DOOR HEIGHT |        |
|-------------|--------|
| NOMINAL     | ACTUAL |
| 6-8         | 79"    |

| GLASS OPTIONS |            |
|---------------|------------|
| SIZE          | CUTOUT     |
| 22 x 36       | 23 x 37    |
| 22 x 38 AT**  | 24 x 39 AT |
| 22 x 64       | 23 x 65    |

\*\*Refer to page 144-145 for non-rectangular cutout dimensions

Note: The dimension shown from bottom of door to bottom of embossment is 1/4" larger on 79 1/4" and 95 1/4" doors.

# 6'8" 2 PANEL CAMBER PLANK

FIBERGLASS DOOR

SATIN SMOOTH | WHITE

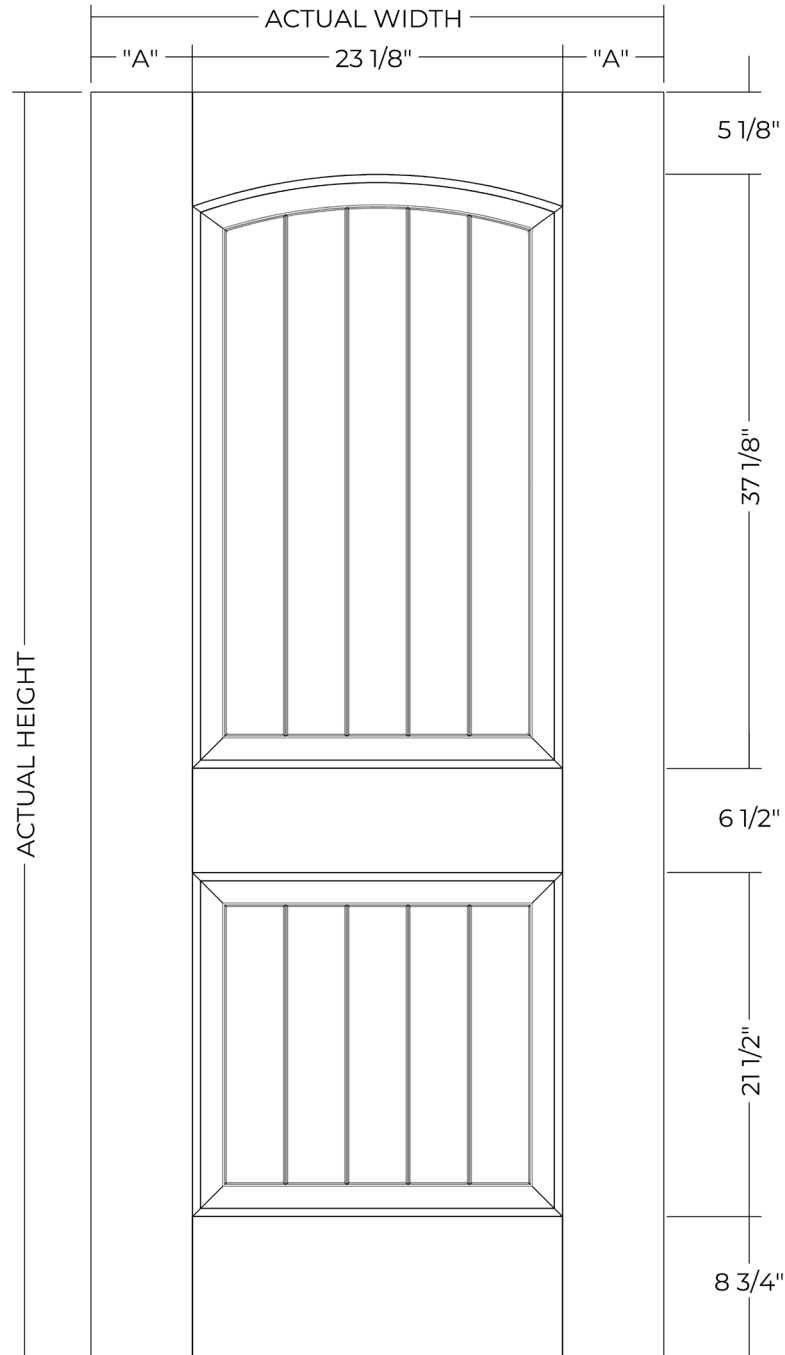

| DOOR WIDTH |         |         |
|------------|---------|---------|
| NOMINAL    | ACTUAL  | "A"     |
| 2-8        | 31 3/4" | 4 5/16" |
| 2-10       | 33 3/4" | 5 5/16" |
| 3-0        | 35 3/4" | 6 5/16" |

| DOOR HEIGHT |        |
|-------------|--------|
| NOMINAL     | ACTUAL |
| 6-8         | 79"    |

| GLASS OPTIONS |            |
|---------------|------------|
| SIZE          | CUTOUT     |
| 22 x 36       | 23 x 37    |
| 22 x 38 AT**  | 24 x 39 AT |
| 22 x 64       | 23 x 65    |

\*\*Refer to page 144-145 for non-rectangular cutout dimensions

Note: The dimension shown from bottom of door to bottom of embossment is 1/4" larger on 79 1/4" and 95 1/4" doors.

# 6'8" FLUSH

FIBERGLASS SIDELIGHT

FINE GRAIN | TAN

RIFT CUT | TAN

SATIN SMOOTH | WHITE

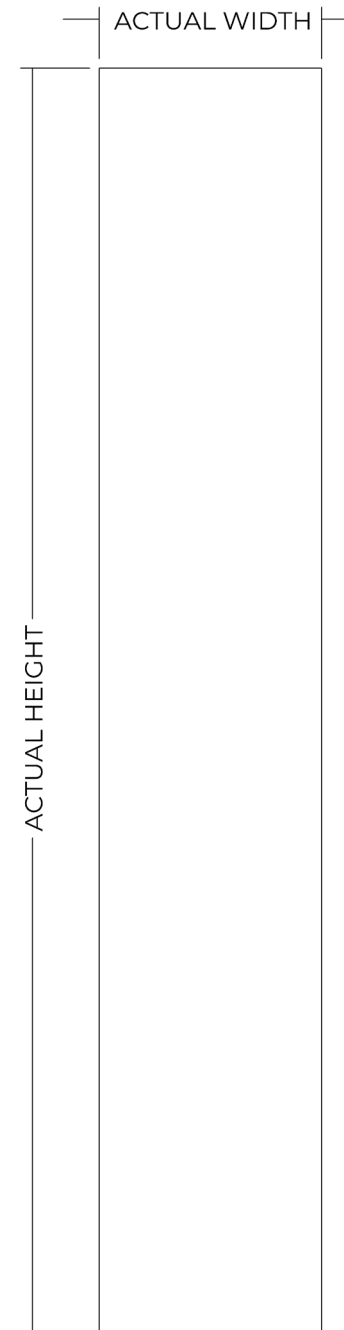

| SIDELIGHT WIDTH |         |
|-----------------|---------|
| NOMINAL         | ACTUAL  |
| 1-0             | 11 7/8" |
| 1-2             | 13 7/8" |

| SIDELIGHT HEIGHT |        |
|------------------|--------|
| NOMINAL          | ACTUAL |
| 6-8              | 79"    |

| GLASS OPTIONS |        |
|---------------|--------|
| SIZE          | CUTOUT |
| 7 x 64        | 8 x 65 |
| 8 x 64        | 9 x 65 |

ESTATE

ESTATE

# 6'8" 2 PANEL REVERSE

FIBERGLASS SIDELIGHT

RIFT CUT | TAN | SATIN SMOOTH | WHITE

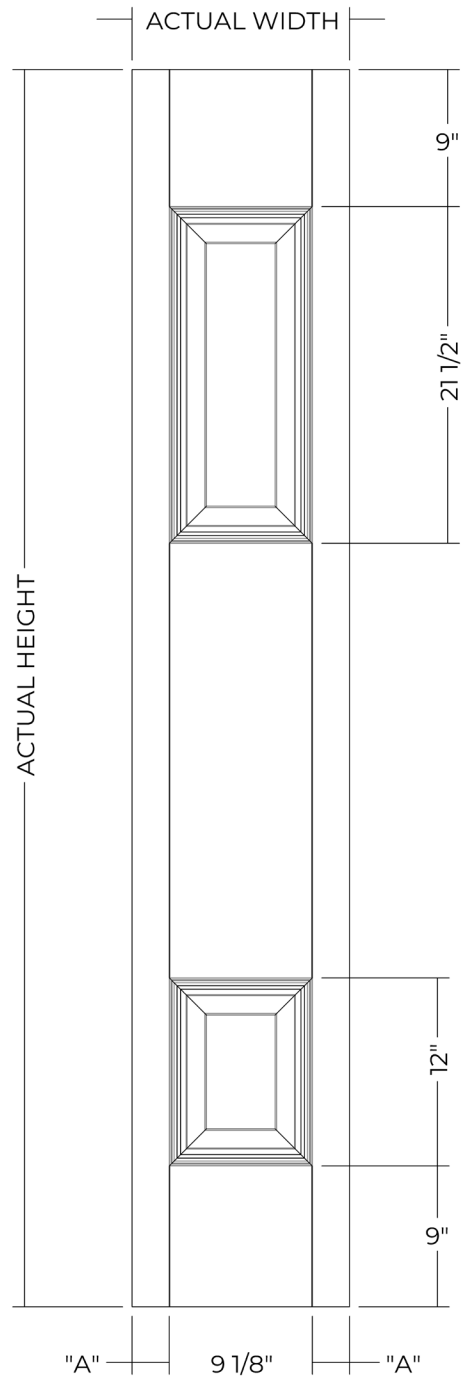

| SIDELIGHT WIDTH |         |          |
|-----------------|---------|----------|
| NOMINAL         | ACTUAL  | "A"      |
| 1-0             | 11 7/8" | 17 1/16" |
| 1-2             | 13 7/8" | 27 1/16" |

| SIDELIGHT HEIGHT |        |
|------------------|--------|
| NOMINAL          | ACTUAL |
| 6-8              | 79"    |

| GLASS OPTIONS |        |
|---------------|--------|
| SIZE          | CUTOUT |
| 8 x 64        | 9 x 65 |
| 8 x 48        | 9 x 49 |

Note: The dimension shown from bottom of door to bottom of embossment is 1/4" larger on 79 1/4" and 95 1/4" doors.

# 6'8" 2 PANEL REVERSE

FIBERGLASS SIDELIGHT

RIFT CUT | TAN | SATIN SMOOTH | WHITE

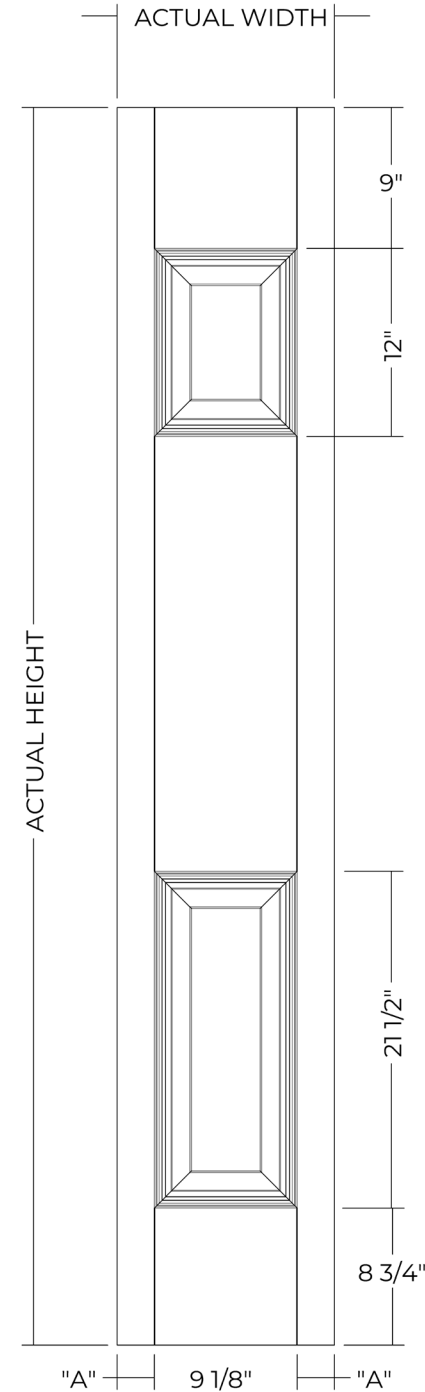

| SIDELIGHT WIDTH |         |          |
|-----------------|---------|----------|
| NOMINAL         | ACTUAL  | "A"      |
| 1-0             | 11 7/8" | 17 1/16" |
| 1-2             | 13 7/8" | 27 1/16" |

| SIDELIGHT HEIGHT |        |
|------------------|--------|
| NOMINAL          | ACTUAL |
| 6-8              | 79"    |

| GLASS OPTIONS |        |
|---------------|--------|
| SIZE          | CUTOUT |
| 8 x 64        | 9 x 65 |
| 8 x 36        | 9 x 37 |

Note: The dimension shown from bottom of door to bottom of embossment is 1/4" larger on 79 1/4" and 95 1/4" doors.

# 6'8" FLUSH 1 LIGHT w/CUTOUT

FIBERGLASS SIDELIGHT

FINE GRAIN | TAN

RIFT CUT | TAN

SATIN SMOOTH | WHITE

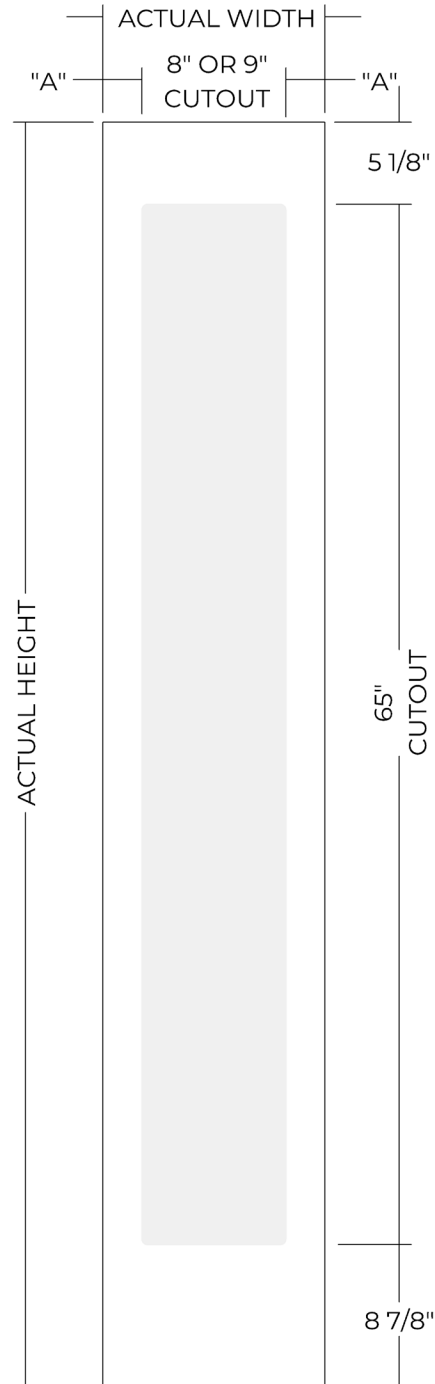

6'8" FLUSH W/ 8"X65" CUTOUT

| SIDELIGHT WIDTH |         |          |
|-----------------|---------|----------|
| NOMINAL         | ACTUAL  | "A"      |
| 1-0             | 11 7/8" | 1 15/16" |
| 1-2             | 13 7/8" | 2 15/16" |

| SIDELIGHT HEIGHT |        |
|------------------|--------|
| NOMINAL          | ACTUAL |
| 6-8              | 79"    |

6'8" FLUSH W/ 9"X65" CUTOUT

| SIDELIGHT WIDTH |         |         |
|-----------------|---------|---------|
| NOMINAL         | ACTUAL  | "A"     |
| 1-0             | 11 7/8" | 1 7/16" |
| 1-2             | 13 7/8" | 2 7/16" |

| SIDELIGHT HEIGHT |        |
|------------------|--------|
| NOMINAL          | ACTUAL |
| 6-8              | 79"    |

| GLASS OPTIONS |        |
|---------------|--------|
| SIZE          | CUTOUT |
| 7 x 64        | 8 x 65 |
| 8 x 64        | 9 x 65 |

# 6'8" 3/4 LIGHT w/9x49 CUTOUT

FIBERGLASS SIDELIGHT

RIFT CUT | TAN

SATIN SMOOTH | WHITE

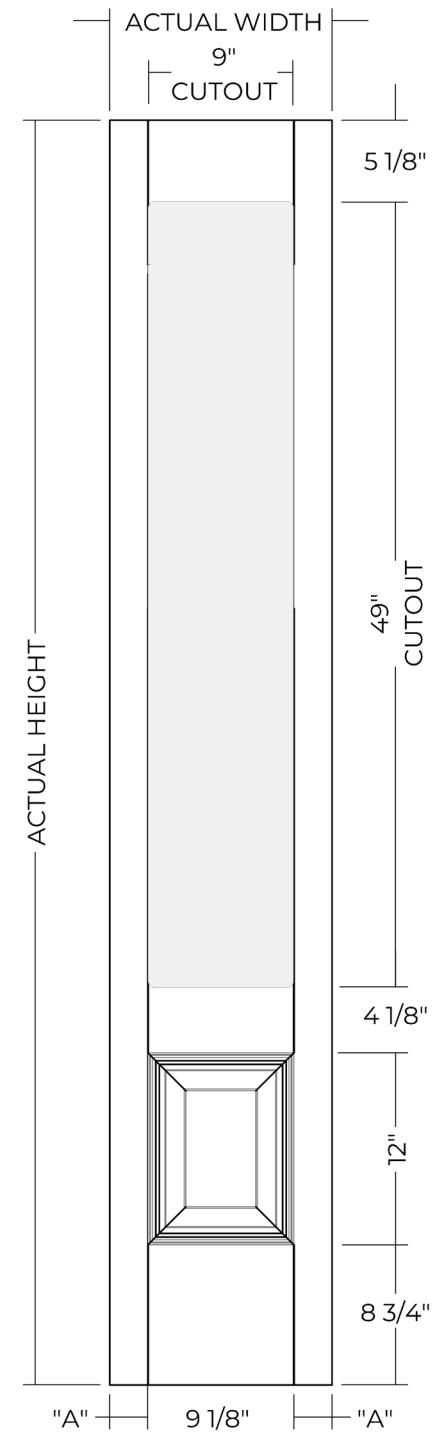

| SIDELIGHT WIDTH |         |         |
|-----------------|---------|---------|
| NOMINAL         | ACTUAL  | "A"     |
| 1-0             | 11 7/8" | 1 7/16" |
| 1-2             | 13 7/8" | 2 7/16" |

| SIDELIGHT HEIGHT |        |
|------------------|--------|
| NOMINAL          | ACTUAL |
| 6-8              | 79"    |

| GLASS OPTIONS |        |
|---------------|--------|
| SIZE          | CUTOUT |
| 8 x 64        | 9 x 65 |
| 8 x 48        | 9 x 49 |

Note: The dimension shown from bottom of door to bottom of embossment is 1/4" larger on 79 1/4" and 95 1/4" doors.

ESTATE

ESTATE

# 6'8" 1/2 LIGHT w/9x37 CUTOUT

FIBERGLASS SIDELIGHT

RIFT CUT | TAN | SATIN SMOOTH | WHITE

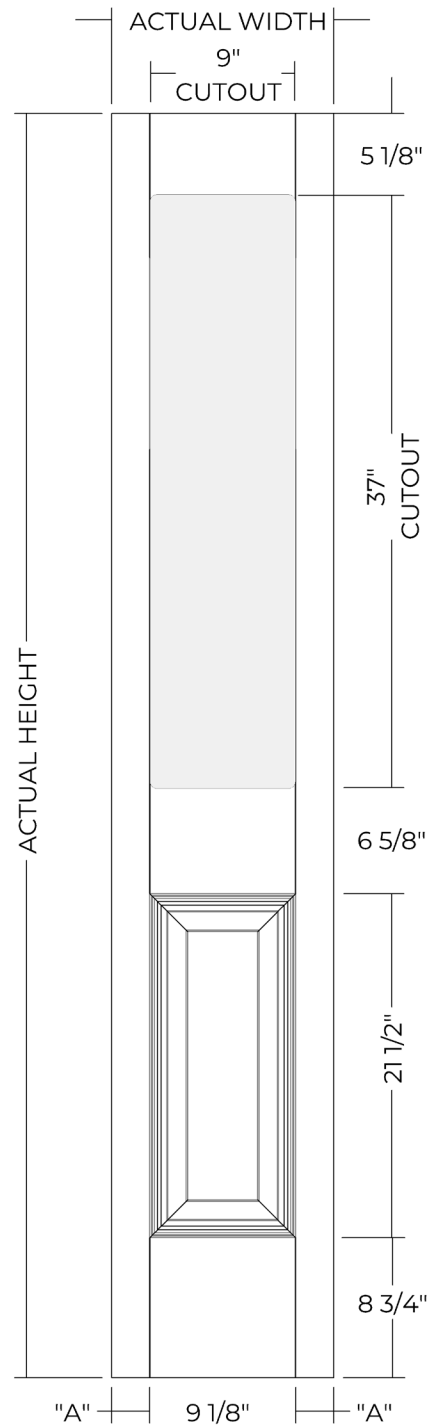

| SIDELIGHT WIDTH |         |          |
|-----------------|---------|----------|
| NOMINAL         | ACTUAL  | "A"      |
| 1-0             | 11 7/8" | 17 1/16" |
| 1-2             | 13 7/8" | 27 1/16" |

| SIDELIGHT HEIGHT |        |
|------------------|--------|
| NOMINAL          | ACTUAL |
| 6-8              | 79"    |

| GLASS OPTIONS |        |
|---------------|--------|
| SIZE          | CUTOUT |
| 8 x 64        | 9 x 65 |
| 8 x 36        | 9 x 37 |

Note: The dimension shown from bottom of door to bottom of embossment is 1/4" larger on 79 1/4" and 95 1/4" doors.

# 7'0" FLUSH

FIBERGLASS DOOR

FINE GRAIN | TAN | RIFT CUT | TAN | SATIN SMOOTH | WHITE

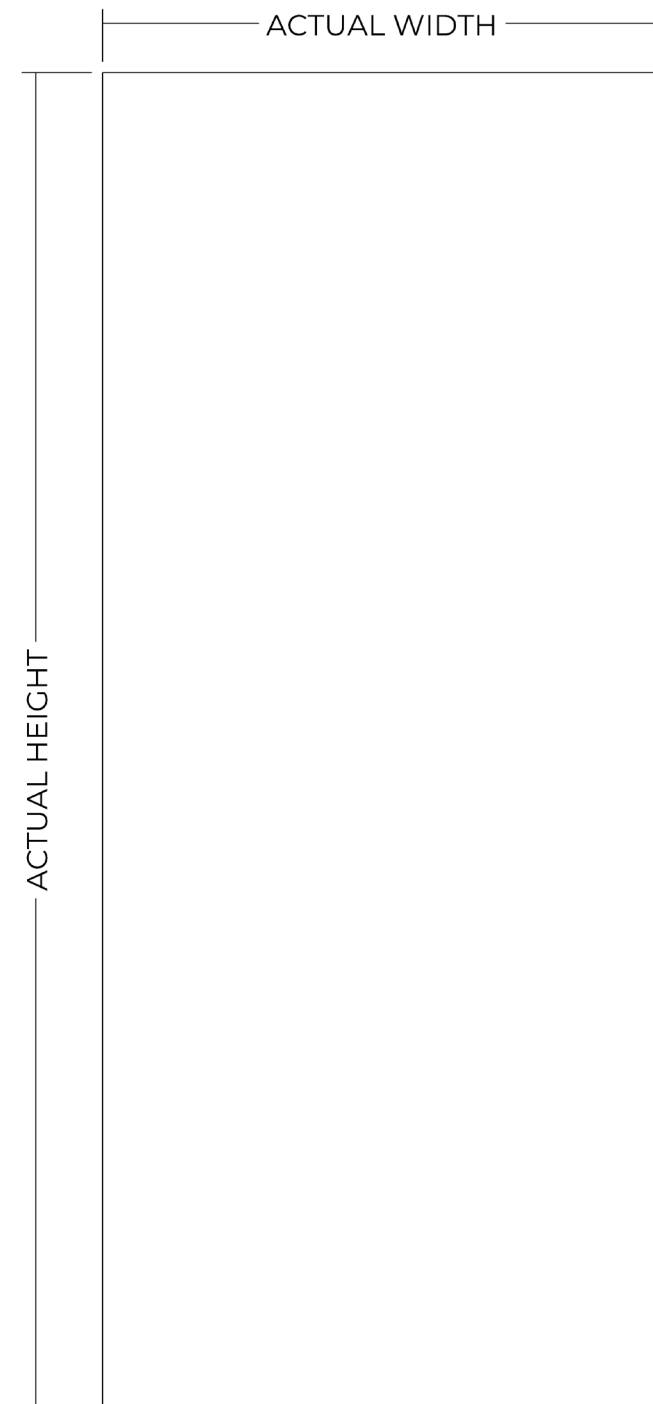

| DOOR WIDTH |         |
|------------|---------|
| NOMINAL    | ACTUAL  |
| 2-6        | 29 3/4" |
| 2-8        | 31 3/4" |
| 2-10       | 33 3/4" |
| 3-0        | 35 3/4" |
| 3-6        | 41 3/4" |

| DOOR HEIGHT |        |
|-------------|--------|
| NOMINAL     | ACTUAL |
| 7-0         | 83"    |

| GLASS OPTIONS |         |
|---------------|---------|
| SIZE          | CUTOUT  |
| 8 x 64        | 9 x 65  |
| 22 x 36       | 23 x 37 |
| 22 x 64       | 23 x 61 |
| 22 x 17 3L    | 23 x 18 |



ESTATE

ESTATE



# 7'0" ADA 6 PANEL

FIBERGLASS DOOR

SATIN SMOOTH | WHITE

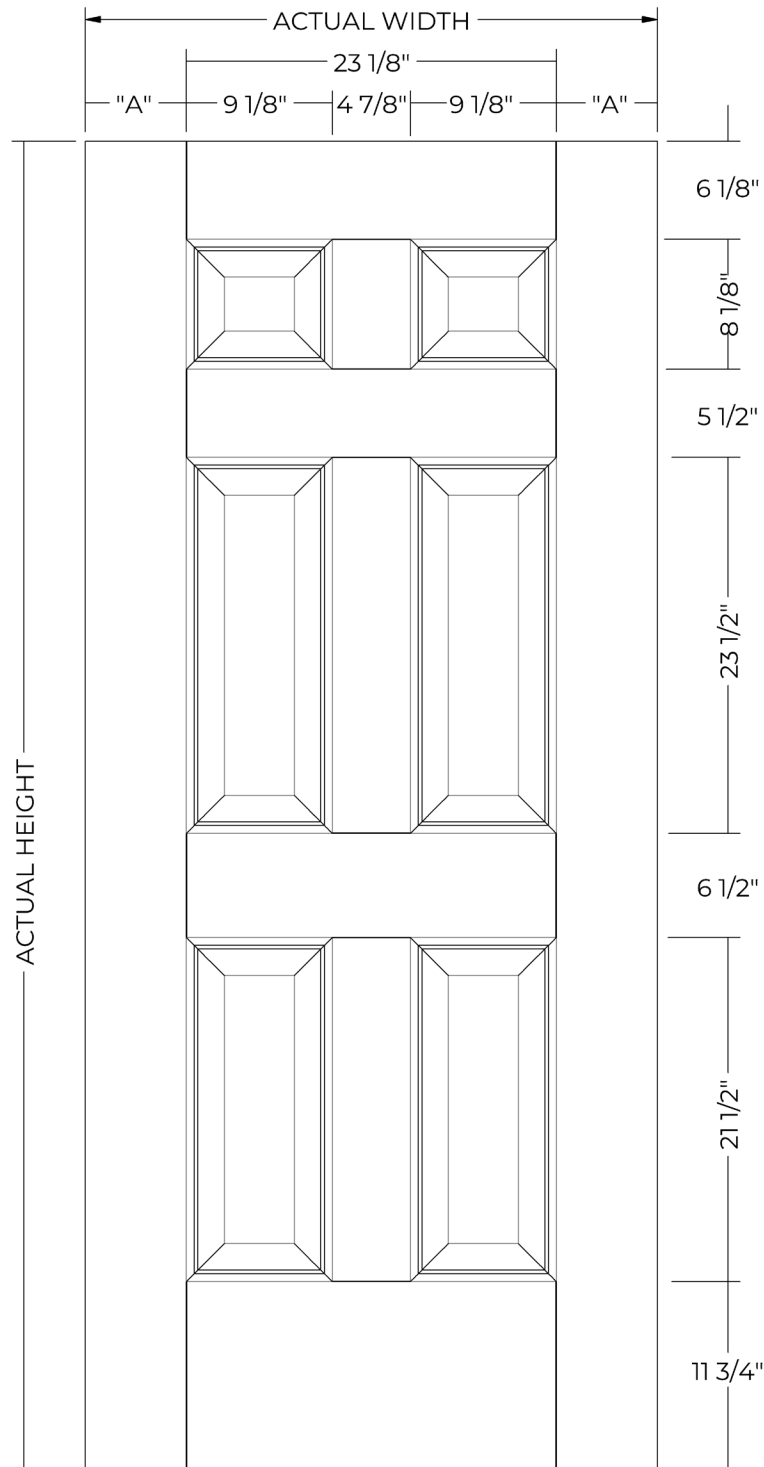

### DOOR WIDTH

| NOMINAL | ACTUAL  | "A"     |
|---------|---------|---------|
| 2-8     | 31 3/4" | 4 5/16" |
| 2-10    | 33 3/4" | 5 5/16" |
| 3-0     | 35 3/4" | 6 5/16" |

### DOOR HEIGHT

| NOMINAL | ACTUAL |
|---------|--------|
| 7-0     | 83"    |

### GLASS OPTIONS

| SIZE     | CUTOUT  |
|----------|---------|
| 22 x 36* | 23 x 37 |
| 22 x 64* | 23 x 65 |



# 7'0" ADA 2 PANEL SQUARE

FIBERGLASS DOOR

SATIN SMOOTH | WHITE

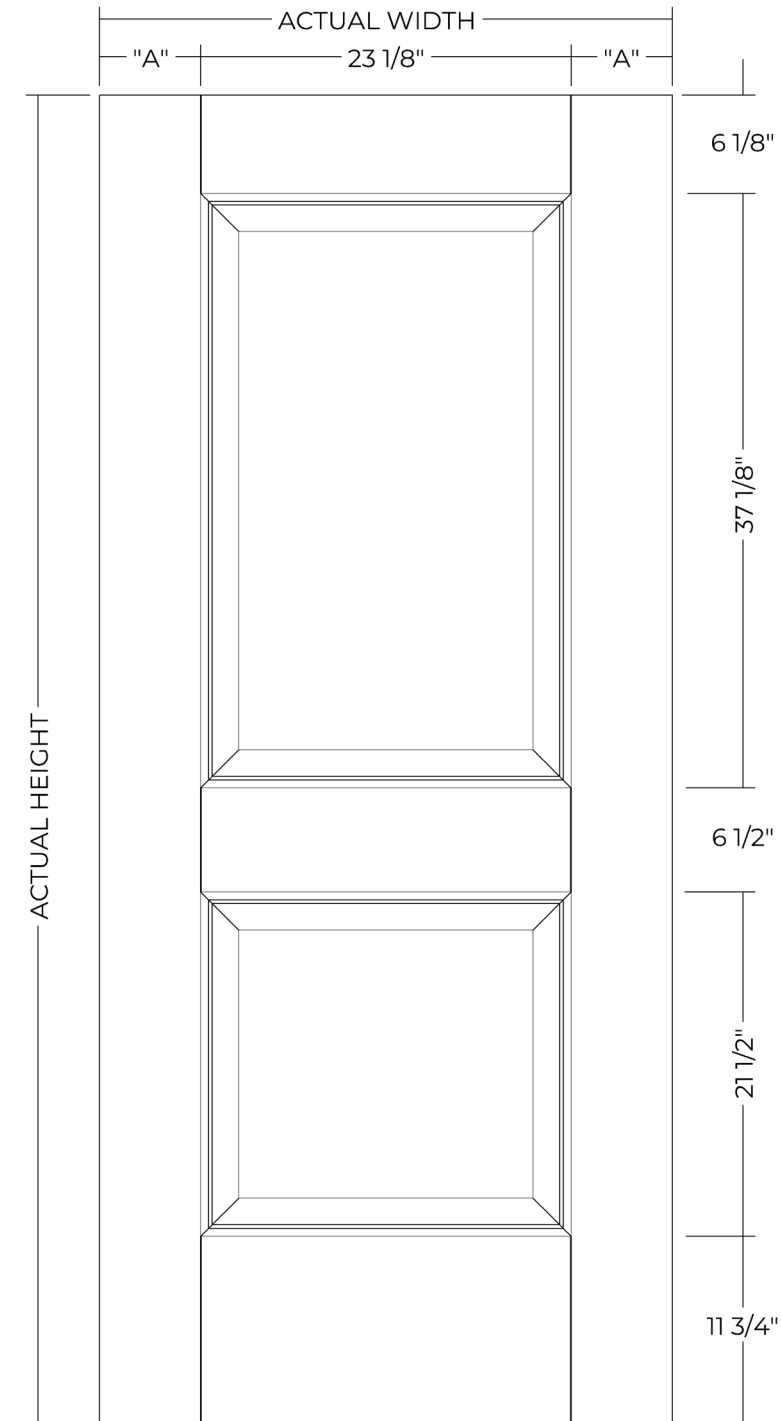

### DOOR WIDTH

| NOMINAL | ACTUAL  | "A"     |
|---------|---------|---------|
| 2-8     | 31 3/4" | 4 5/16" |
| 2-10    | 33 3/4" | 5 5/16" |
| 3-0     | 35 3/4" | 6 5/16" |

### DOOR HEIGHT

| NOMINAL | ACTUAL |
|---------|--------|
| 7-0     | 83"    |

### GLASS OPTIONS

| SIZE     | CUTOUT  |
|----------|---------|
| 22 x 36* | 23 x 37 |
| 22 x 64* | 23 x 65 |



ESTATE

ESTATE

# 8'0" FLUSH FIBERGLASS DOOR

FINE GRAIN | TAN

RIFT CUT | TAN

SATIN SMOOTH | WHITE

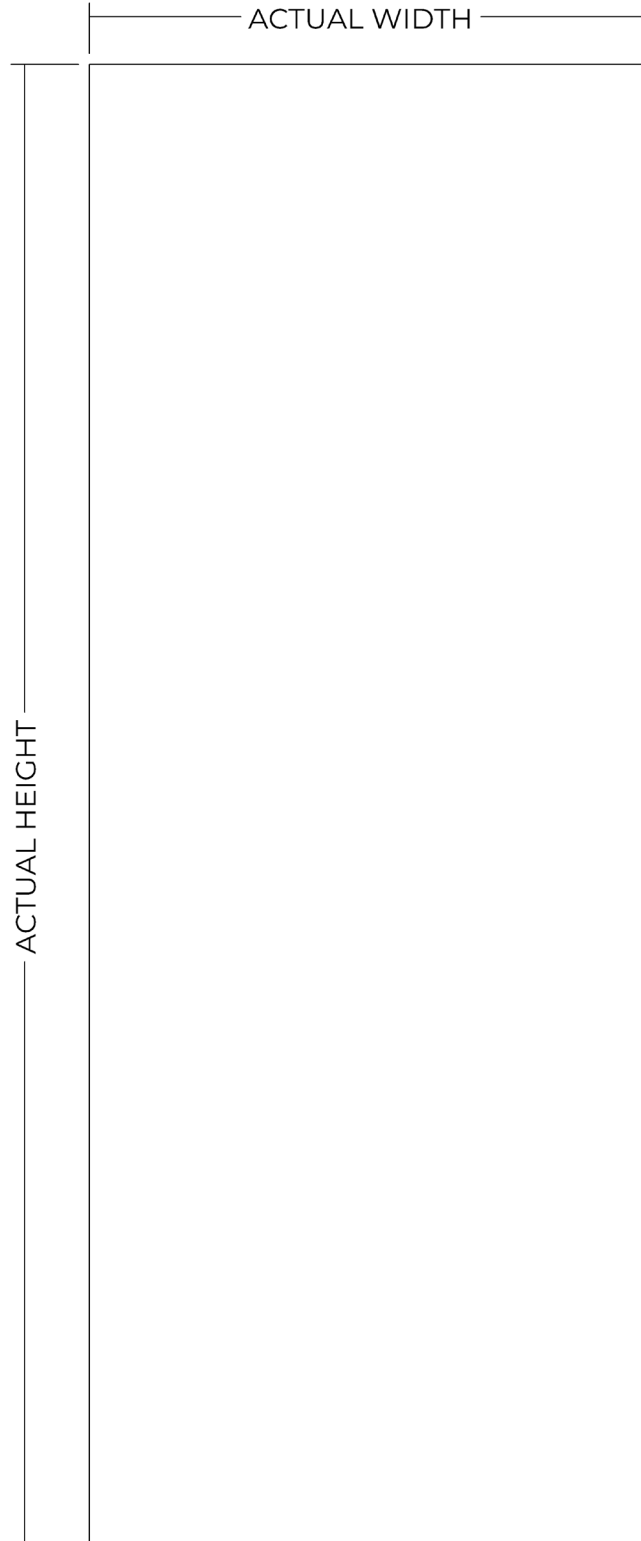

| DOOR WIDTH |         |
|------------|---------|
| NOMINAL    | ACTUAL  |
| 2-6        | 29 3/4" |
| 2-8        | 31 3/4" |
| 2-10       | 33 3/4" |
| 3-0        | 35 3/4" |
| 3-6        | 41 3/4" |

| DOOR HEIGHT |        |
|-------------|--------|
| NOMINAL     | ACTUAL |
| 8-0         | 95"    |

| GLASS OPTIONS |         |
|---------------|---------|
| SIZE          | CUTOUT  |
| 8 x 80        | 9 x 81  |
| 22 x 76*      | 23 x 77 |
| 22 x 80       | 23 x 81 |
| 22 x 17       | 23 x 18 |
| 7 x 64        | 8 x 64  |
| 8 x 64        | 9 x 65  |
| 22 x 17 3L    | 23 x 18 |
| 14 x 80       | 15 x 81 |

 ADA COMPLIANT\*

# 8'0" 6 PANEL FIBERGLASS DOOR

RIFT CUT | TAN

SATIN SMOOTH | WHITE

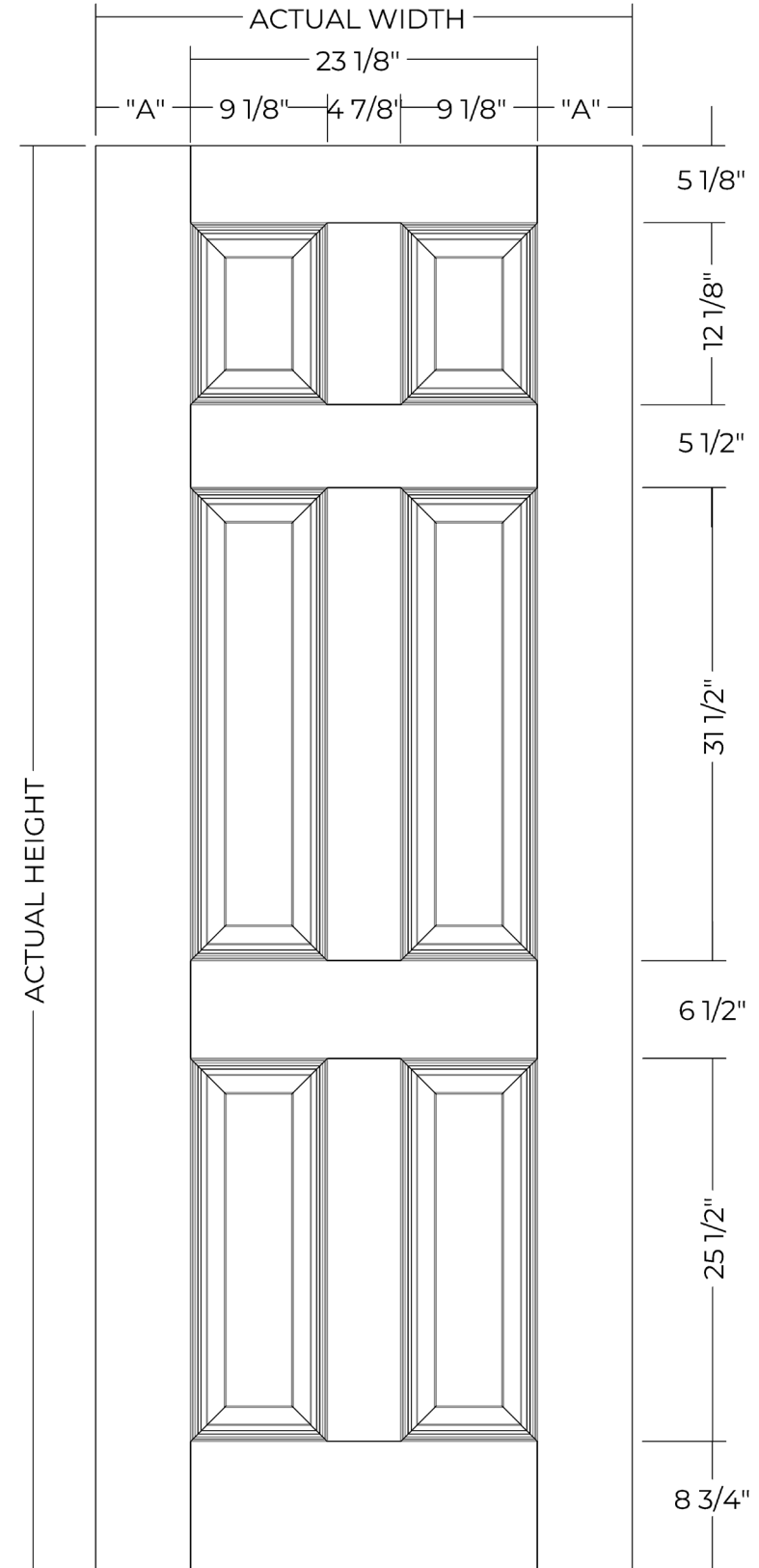

| DOOR WIDTH |         |         |
|------------|---------|---------|
| NOMINAL    | ACTUAL  | "A"     |
| 2-8        | 31 3/4" | 4 5/16" |
| 2-10       | 33 3/4" | 5 5/16" |
| 3-0        | 35 3/4" | 6 5/16" |

| DOOR HEIGHT |        |
|-------------|--------|
| NOMINAL     | ACTUAL |
| 8-0         | 95"    |

| GLASS OPTIONS |         |
|---------------|---------|
| SIZE          | CUTOUT  |
| 22 x 48       | 23 x 49 |
| 22 x 80       | 23 x 81 |

Note: The dimension shown from bottom of door to bottom of embossment is 1/4" larger on 79 1/4" and 95 1/4" doors.

ESTATE

ESTATE

# 8'0" 2 PANEL 3/4 TOP

FIBERGLASS DOOR

RIFT CUT | TAN | SATIN SMOOTH | WHITE

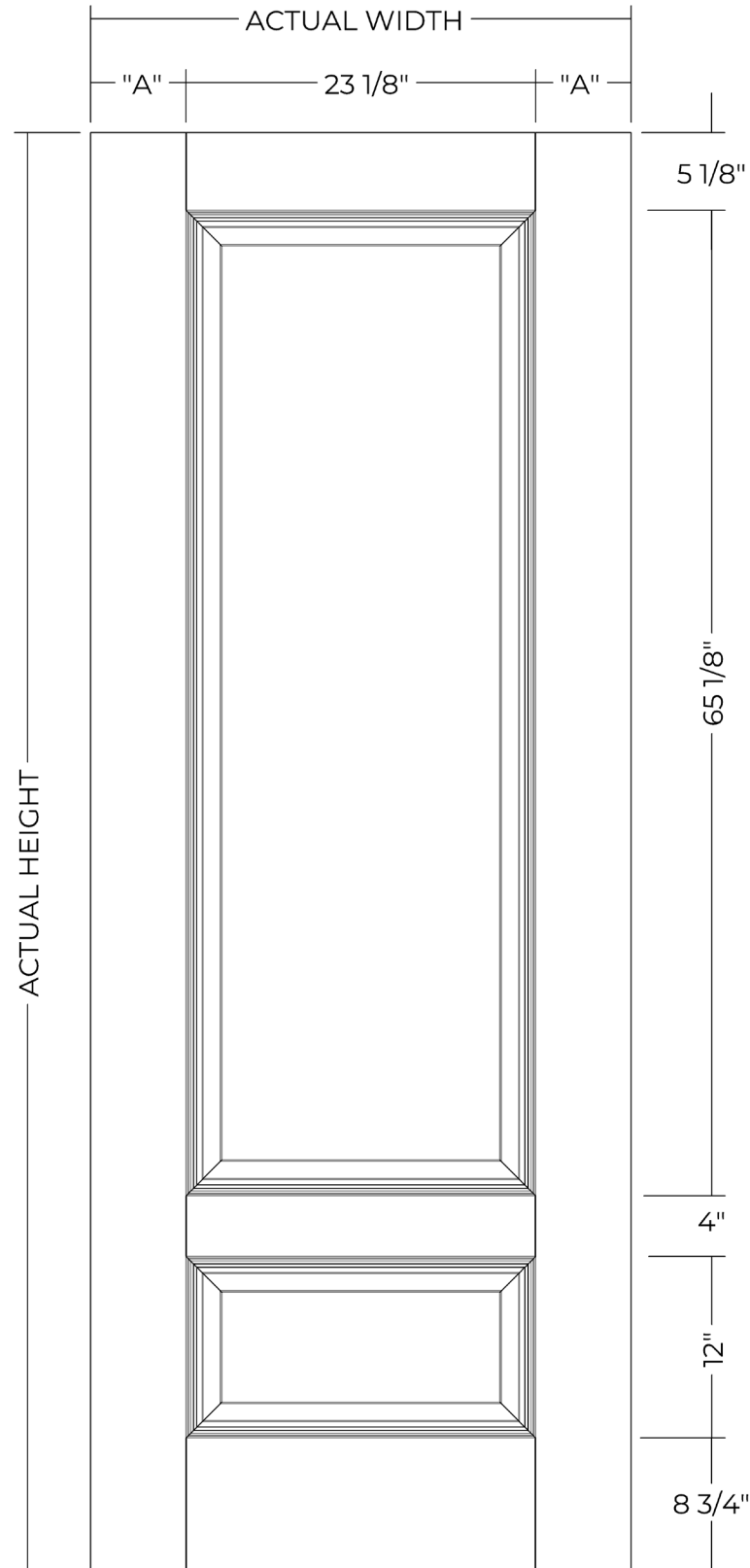

### DOOR WIDTH

| NOMINAL | ACTUAL  | "A"     |
|---------|---------|---------|
| 2-8     | 31 3/4" | 4 5/16" |
| 2-10    | 33 3/4" | 5 5/16" |
| 3-0     | 35 3/4" | 6 5/16" |

### DOOR HEIGHT

| NOMINAL | ACTUAL |
|---------|--------|
| 8-0     | 95"    |

### GLASS OPTIONS

| SIZE    | CUTOUT  |
|---------|---------|
| 22 x 64 | 23 x 65 |
| 22 x 80 | 23 x 81 |

Note: The dimension shown from bottom of door to bottom of embossment is 1/4" larger on 79 1/4" and 95 1/4" doors.

# 8'0" 2 PANEL SQUARE

FIBERGLASS DOOR

RIFT CUT | TAN | SATIN SMOOTH | WHITE

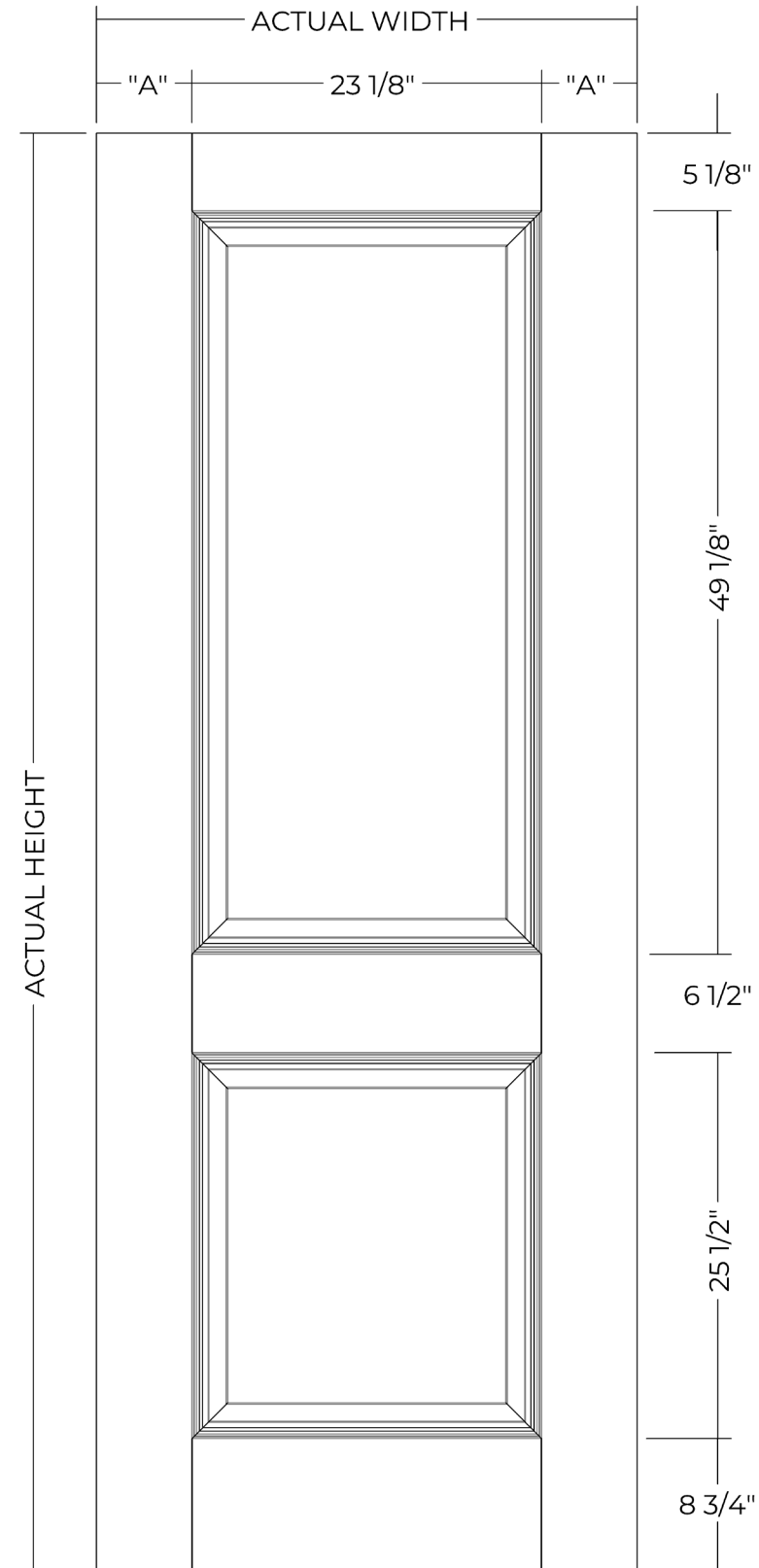

### DOOR WIDTH

| NOMINAL | ACTUAL  | "A"     |
|---------|---------|---------|
| 2-8     | 31 3/4" | 4 5/16" |
| 2-10    | 33 3/4" | 5 5/16" |
| 3-0     | 35 3/4" | 6 5/16" |

### DOOR HEIGHT

| NOMINAL | ACTUAL |
|---------|--------|
| 8-0     | 95"    |

### GLASS OPTIONS

| SIZE    | CUTOUT  |
|---------|---------|
| 22 x 48 | 23 x 49 |
| 22 x 80 | 23 x 81 |

Note: The dimension shown from bottom of door to bottom of embossment is 1/4" larger on 79 1/4" and 95 1/4" doors.

# 8'0" FLUSH

FIBERGLASS SIDELIGHT

FINE GRAIN | TAN

RIFT CUT | TAN

SATIN SMOOTH | WHITE

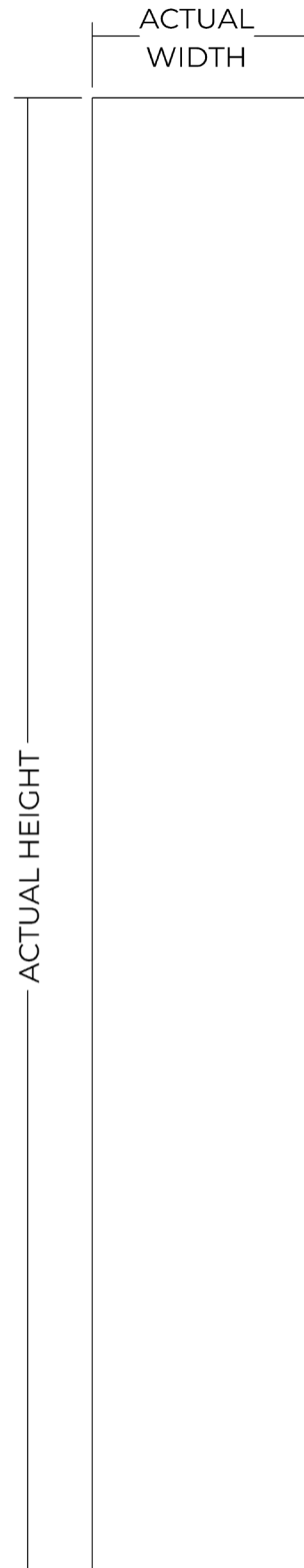

| SIDELIGHT WIDTH |         |
|-----------------|---------|
| NOMINAL         | ACTUAL  |
| 1-0             | 11 7/8" |
| 1-2             | 13 7/8" |

| SIDELIGHT HEIGHT |        |
|------------------|--------|
| NOMINAL          | ACTUAL |
| 8-0              | 95"    |

| GLASS OPTIONS |        |
|---------------|--------|
| SIZE          | CUTOUT |
| 8 x 80        | 9 x 81 |

# 8'0" FLUSH 1 LIGHT w/CUTOUT

FIBERGLASS SIDELIGHT

FINE GRAIN | TAN

RIFT CUT | TAN

SATIN SMOOTH | WHITE

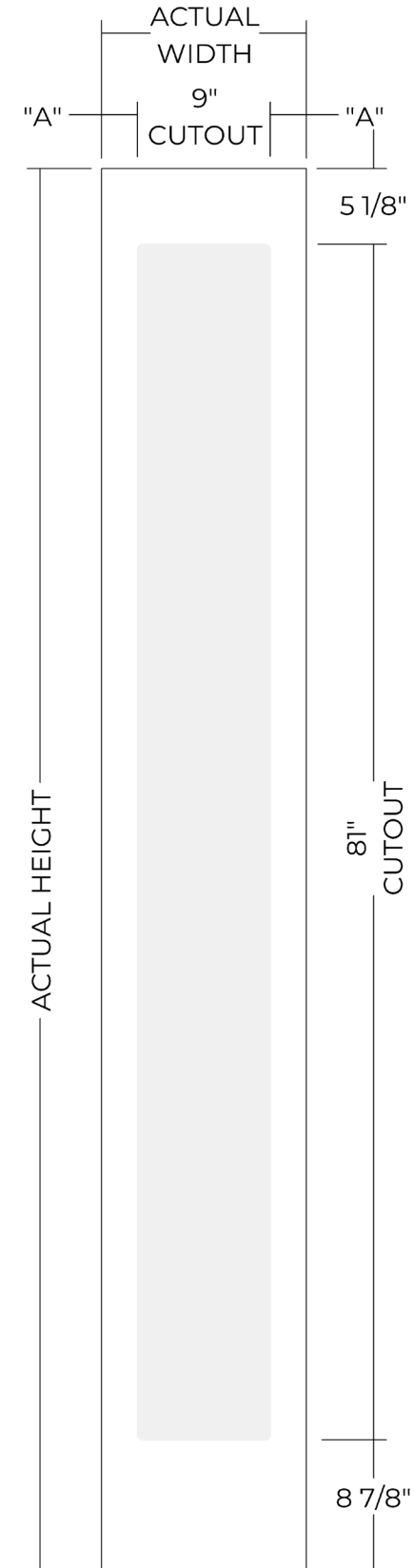

| 8'0" FLUSH W/9"x81" CUTOUT |         |          |
|----------------------------|---------|----------|
| SIDELIGHT WIDTH            |         |          |
| NOMINAL                    | ACTUAL  | "A"      |
| 1-0                        | 11 7/8" | 17 1/16" |
| 1-2                        | 13 7/8" | 27 1/16" |

| SIDELIGHT HEIGHT |        |
|------------------|--------|
| NOMINAL          | ACTUAL |
| 8-0              | 95"    |

| GLASS OPTIONS |        |
|---------------|--------|
| SIZE          | CUTOUT |
| 8 x 80        | 9 x 81 |

ESTATE

ESTATE

# 8'0" 3/4 LIGHT w/9x65 CUTOUT

FIBERGLASS SIDELIGHT

RIFT CUT | TAN

SATIN SMOOTH | WHITE

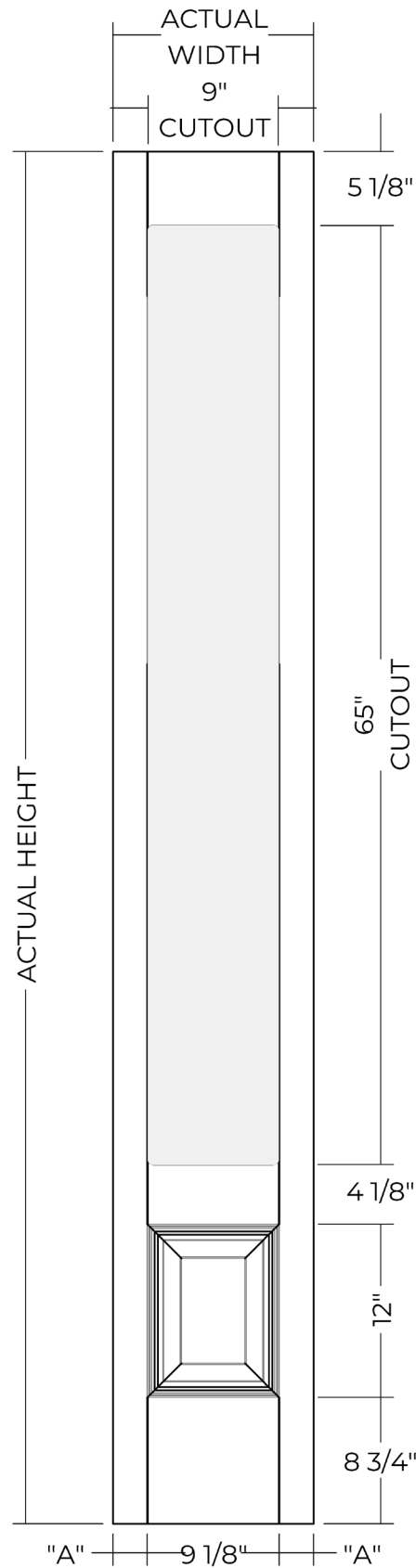

| SIDELIGHT WIDTH |         |          |
|-----------------|---------|----------|
| NOMINAL         | ACTUAL  | "A"      |
| 1-0             | 11 7/8" | 17 1/16" |
| 1-2             | 13 7/8" | 27 1/16" |

| SIDELIGHT HEIGHT |        |
|------------------|--------|
| NOMINAL          | ACTUAL |
| 8-0              | 95"    |

| GLASS OPTIONS |        |
|---------------|--------|
| SIZE          | CUTOUT |
| 8 x 80        | 9 x 81 |
| 8 x 64        | 9 x 65 |

Note: The dimension shown from bottom of door to bottom of embossment is 1/4" larger on 79 1/4" and 95 1/4" doors.

# 8'0" 1/2 LIGHT w/9x49 CUTOUT

FIBERGLASS SIDELIGHT

RIFT CUT | TAN

SATIN SMOOTH | WHITE

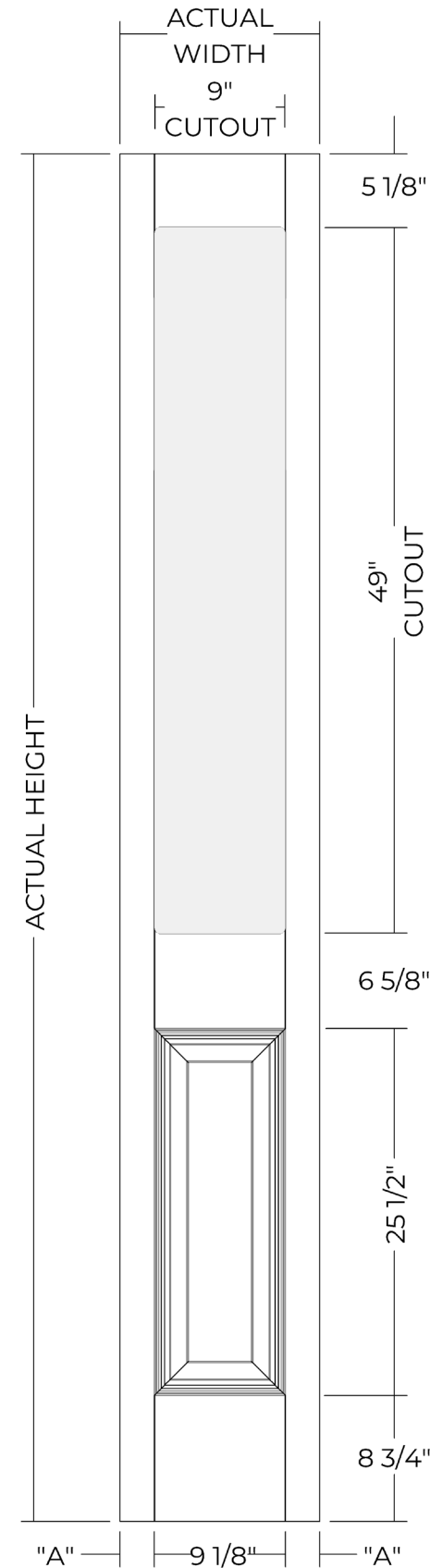

| SIDELIGHT WIDTH |         |          |
|-----------------|---------|----------|
| NOMINAL         | ACTUAL  | "A"      |
| 1-0             | 11 7/8" | 17 1/16" |
| 1-2             | 13 7/8" | 27 1/16" |

| SIDELIGHT HEIGHT |        |
|------------------|--------|
| NOMINAL          | ACTUAL |
| 8-0              | 95"    |

| GLASS OPTIONS |        |
|---------------|--------|
| SIZE          | CUTOUT |
| 8 x 80        | 9 x 81 |
| 8 x 48        | 9 x 49 |

Note: The dimension shown from bottom of door to bottom of embossment is 1/4" larger on 79 1/4" and 95 1/4" doors.

# SHAKER

FIBERGLASS DOORS AND SIDELIGHTS



# 6'8" 1 PANEL SHAKER

FIBERGLASS DOOR

RIFT CUT | TAN | SATIN SMOOTH | WHITE

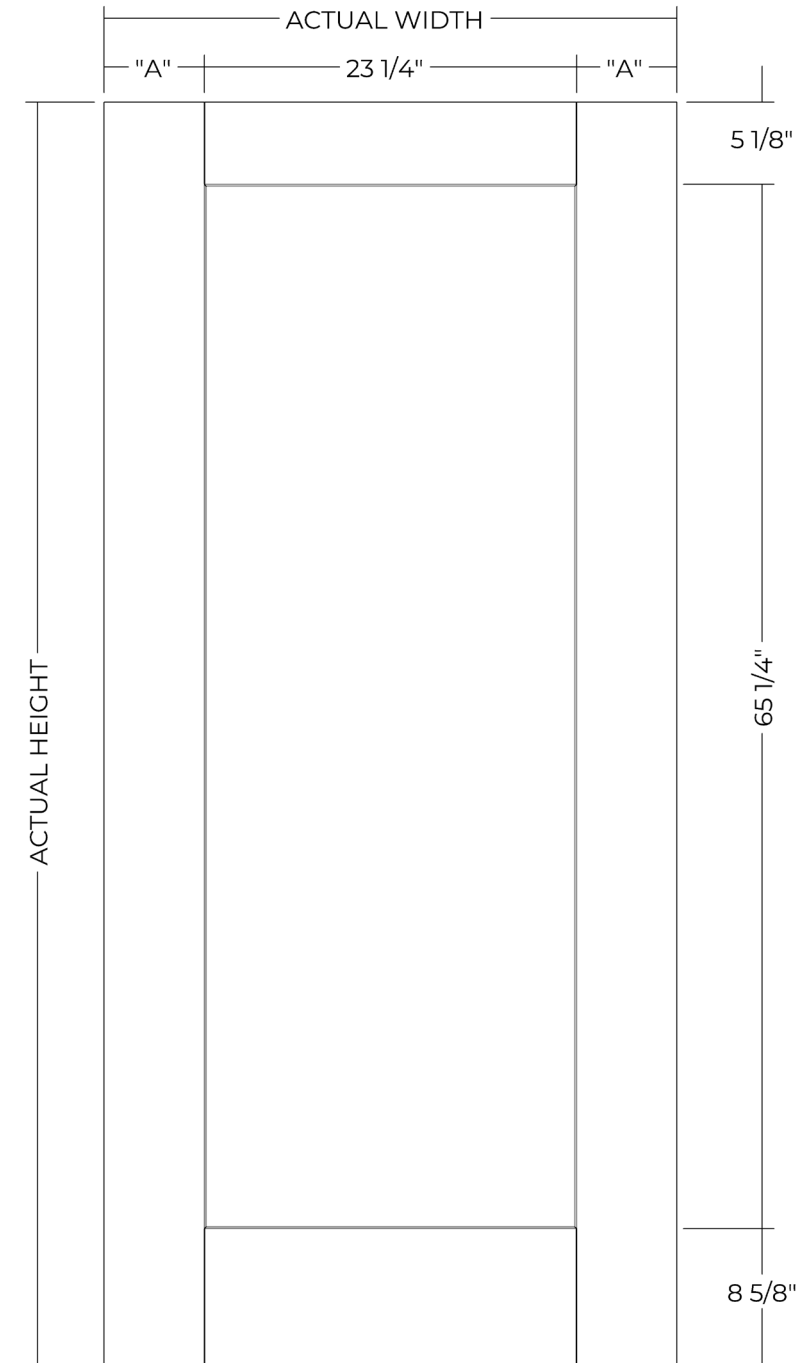

| DOOR WIDTH |         |        |
|------------|---------|--------|
| NOMINAL    | ACTUAL  | "A"    |
| 2-8        | 31 3/4" | 4 1/4" |
| 2-10       | 33 3/4" | 5 1/4" |
| 3-0        | 35 3/4" | 6 1/4" |

| DOOR HEIGHT |        |
|-------------|--------|
| NOMINAL     | ACTUAL |
| 6-8         | 79"    |

| GLASS OPTIONS |         |
|---------------|---------|
| SIZE          | CUTOUT  |
| 22 x 64       | 23 x 65 |

SHAKER

# 6'8" 2 PANEL SHAKER

FIBERGLASS DOOR

SATIN SMOOTH | WHITE

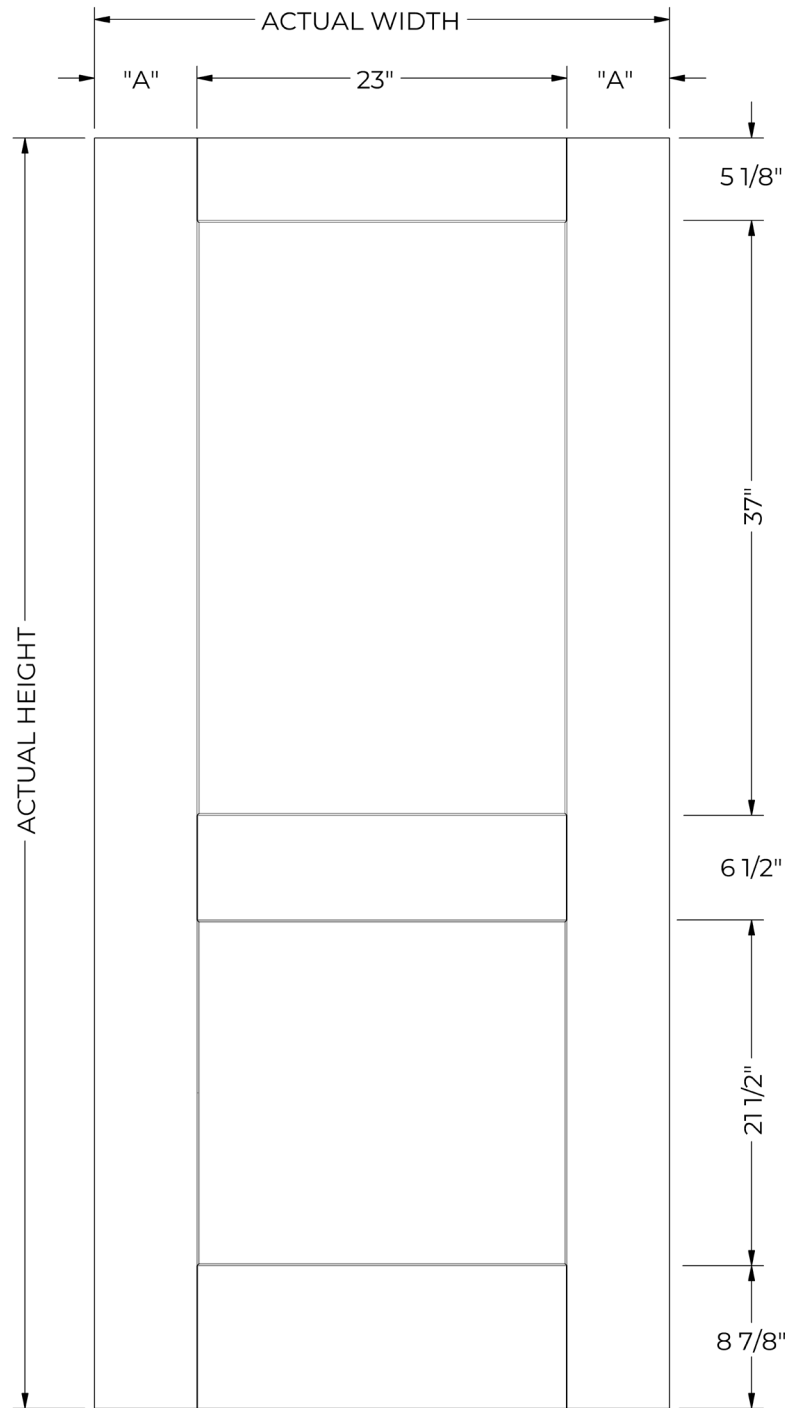

## DOOR WIDTH

| NOMINAL | ACTUAL  | "A"    |
|---------|---------|--------|
| 2-8     | 31 3/4" | 4 3/8" |
| 2-10    | 33 3/4" | 5 3/8" |
| 3-0     | 35 3/4" | 6 3/8" |

## DOOR HEIGHT

| NOMINAL | ACTUAL |
|---------|--------|
| 6-8     | 79"    |

## GLASS OPTIONS

| SIZE    | CUTOUT  |
|---------|---------|
| 22 x 36 | 23 x 37 |
| 22 x 64 | 23 x 65 |

# 6'8" 3 PANEL SHAKER

FIBERGLASS DOOR

SATIN SMOOTH | WHITE

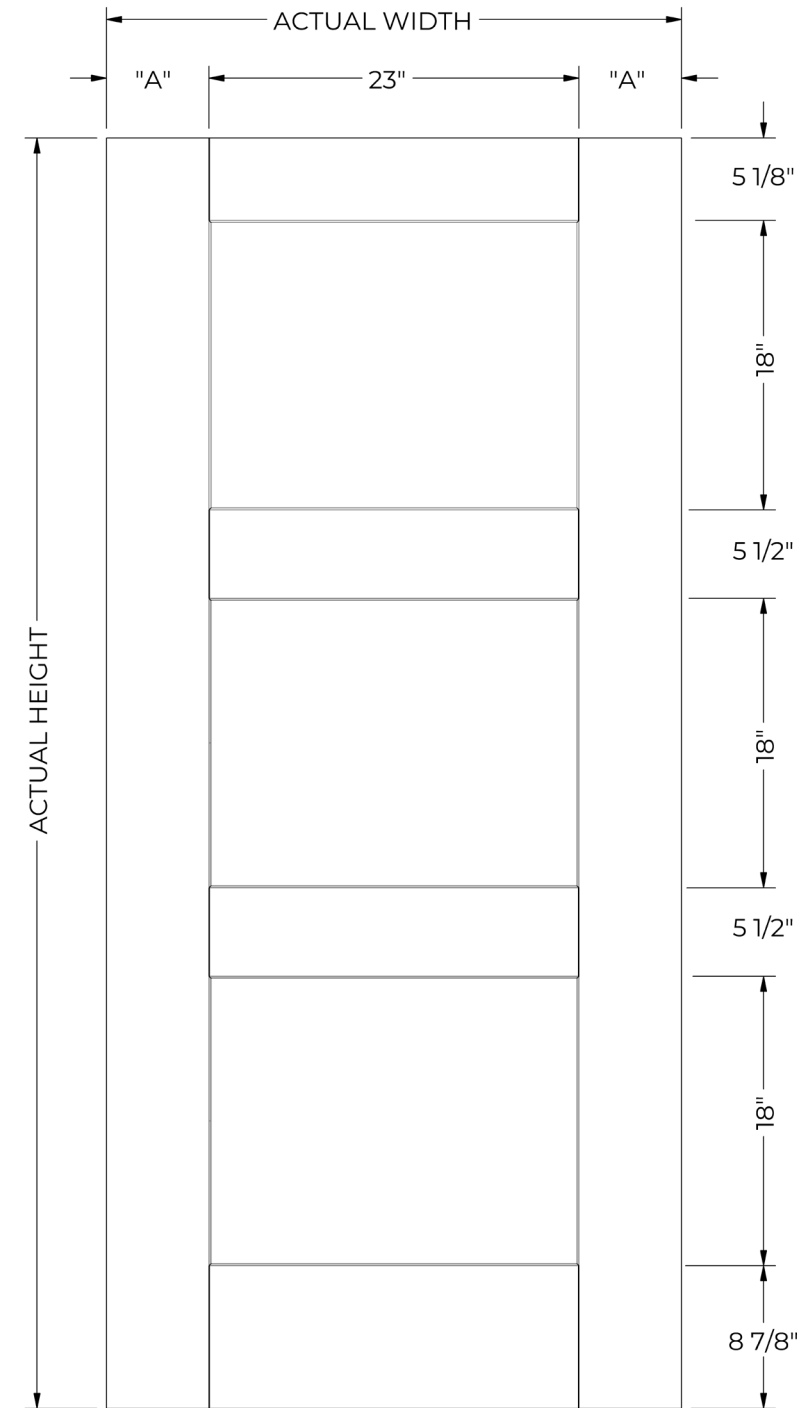

## DOOR WIDTH

| NOMINAL | ACTUAL  | "A"    |
|---------|---------|--------|
| 2-8     | 31 3/4" | 4 3/8" |
| 2-10    | 33 3/4" | 5 3/8" |
| 3-0     | 35 3/4" | 6 3/8" |

## DOOR HEIGHT

| NOMINAL | ACTUAL |
|---------|--------|
| 6-8     | 79"    |

## GLASS OPTIONS

| SIZE       | CUTOUT  |
|------------|---------|
| 22 x 17 3L | 23 x 18 |
| 22 x 64    | 23 x 65 |

SHAKER

SHAKER

# 6'8" 5 PANEL SHAKER

FIBERGLASS DOOR

SATIN SMOOTH | WHITE

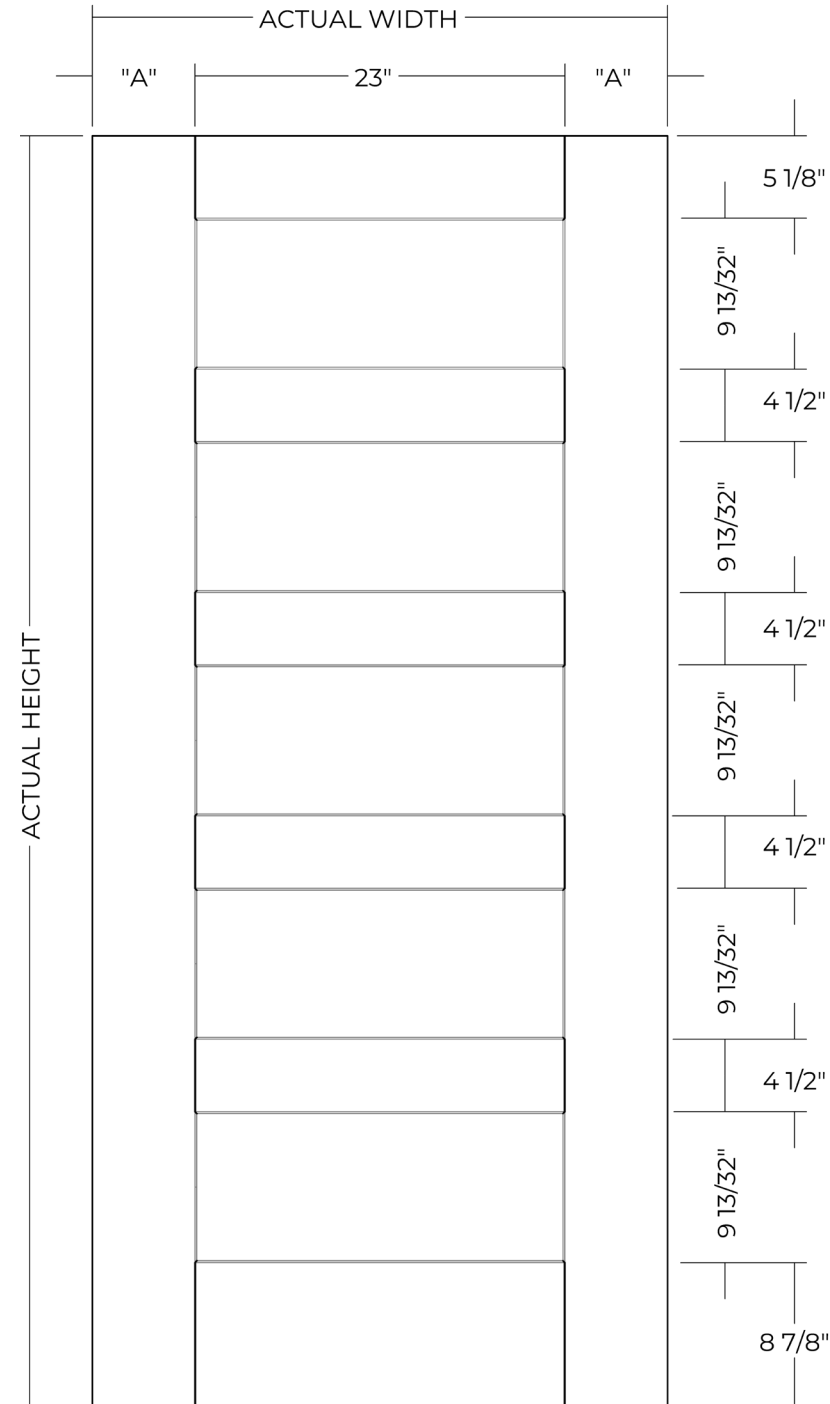

## DOOR WIDTH

| NOMINAL | ACTUAL  | "A"    |
|---------|---------|--------|
| 2-8     | 31 3/4" | 4 3/8" |
| 2-10    | 33 3/4" | 5 3/8" |
| 3-0     | 35 3/4" | 6 3/8" |

## DOOR HEIGHT

| NOMINAL | ACTUAL |
|---------|--------|
| 6-8     | 79"    |

## GLASS OPTIONS

| SIZE    | CUTOUT  |
|---------|---------|
| 22 x 64 | 23 x 65 |

# 6'8" 3 PANEL CRAFTSMAN

FIBERGLASS DOOR

RIFT CUT | TAN | SATIN SMOOTH | WHITE

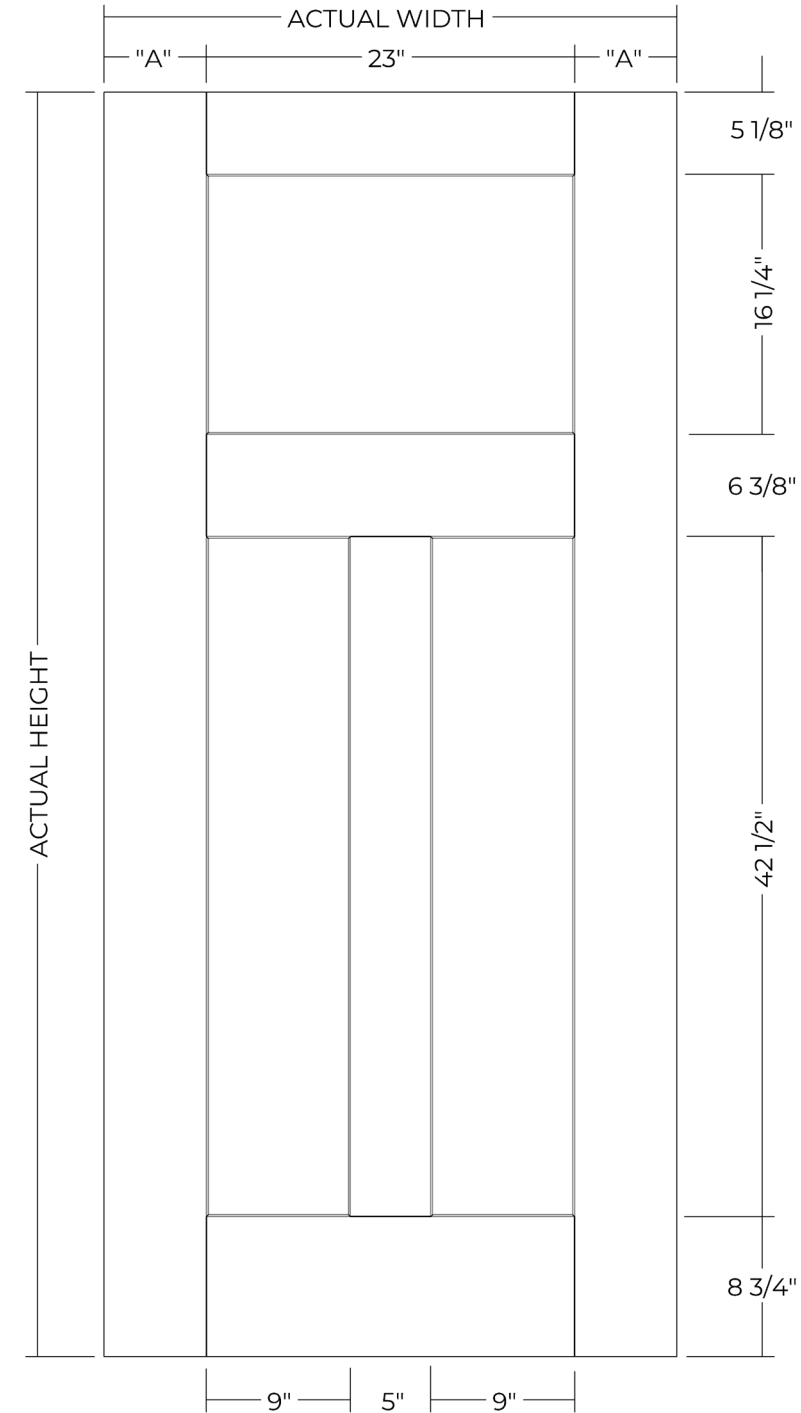

## DOOR WIDTH

| NOMINAL | ACTUAL  | "A"     |
|---------|---------|---------|
| 2-8     | 31 3/4" | 4 5/16" |
| 2-10    | 33 3/4" | 5 5/16" |
| 3-0     | 35 3/4" | 6 5/16" |

## DOOR HEIGHT

| NOMINAL | ACTUAL |
|---------|--------|
| 6-8     | 79"    |

## GLASS OPTIONS

| SIZE    | CUTOUT  |
|---------|---------|
| 22 x 17 | 23 x 18 |
| 22 x 64 | 23 x 65 |

SHAKER

SHAKER



# 6'8" CRAFTSMAN

FIBERGLASS SIDELIGHT

RIFT CUT | TAN

SATIN SMOOTH | WHITE

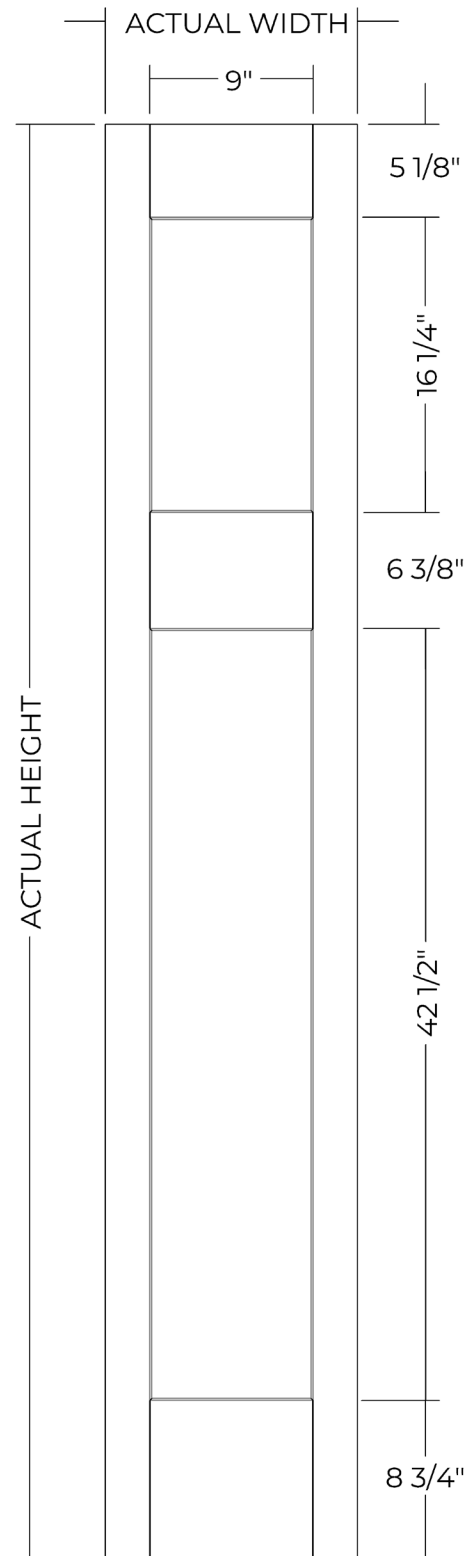

### SIDELIGHT WIDTH

| NOMINAL | ACTUAL  | "A"      |
|---------|---------|----------|
| 1-0     | 11 7/8" | 1 13/16" |
| 1-2     | 13 7/8" | 2 13/16" |

### SIDELIGHT HEIGHT

| NOMINAL | ACTUAL |
|---------|--------|
| 6-8     | 79"    |

### GLASS OPTIONS

| SIZE   | CUTOUT |
|--------|--------|
| 8 x 17 | 9 x 18 |

# 8'0" 1 PANEL SHAKER

FIBERGLASS DOOR

RIFT CUT | TAN

SATIN SMOOTH | WHITE

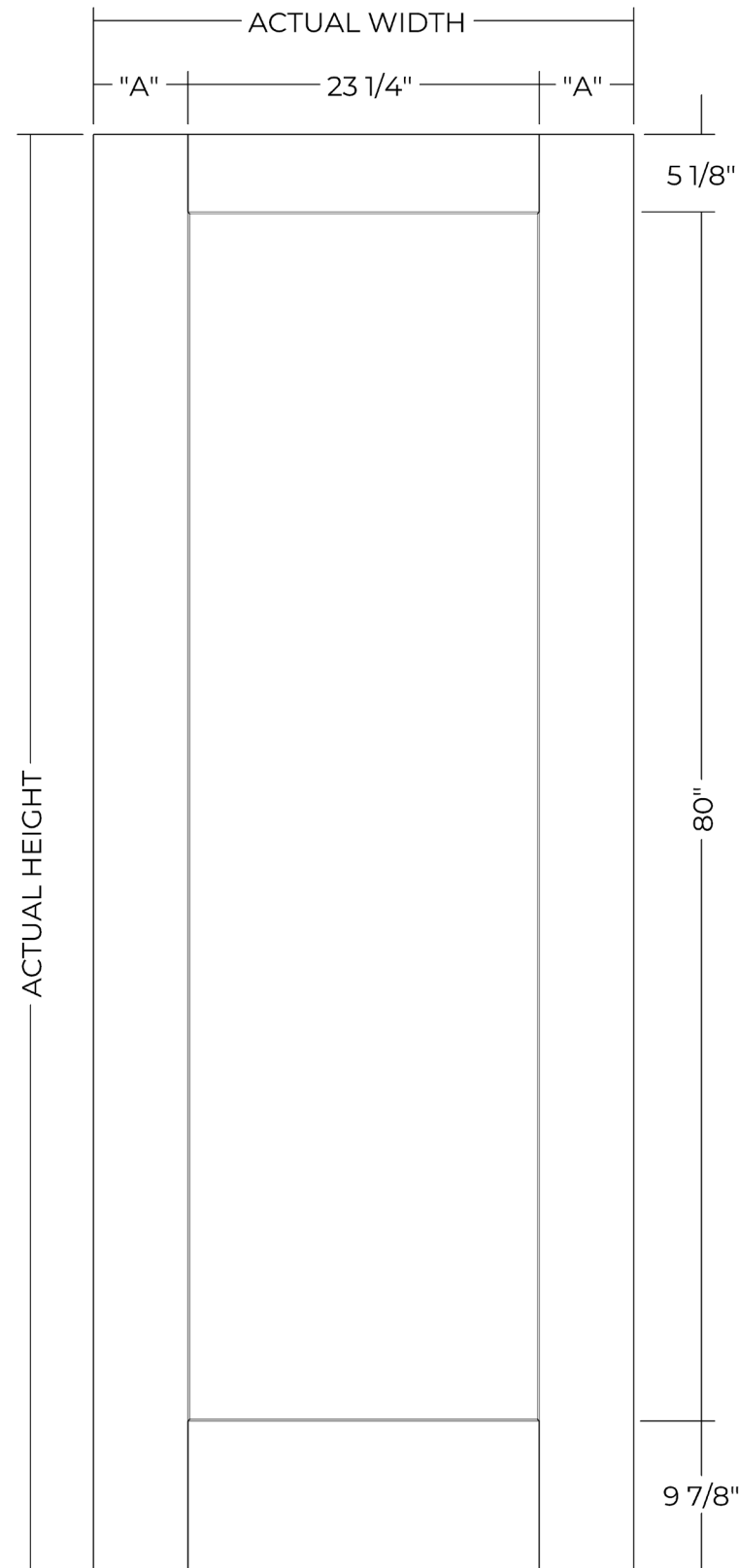

### DOOR WIDTH

| NOMINAL | ACTUAL  | "A"    |
|---------|---------|--------|
| 2-8     | 31 3/4" | 4 1/4" |
| 2-10    | 33 3/4" | 5 1/4" |
| 3-0     | 35 3/4" | 6 1/4" |

### DOOR HEIGHT

| NOMINAL | ACTUAL |
|---------|--------|
| 8-0     | 95"    |

### GLASS OPTIONS

| SIZE    | CUTOUT  |
|---------|---------|
| 22 x 80 | 23 x 81 |

SHAKER

SHAKER

# 8'0" 2 PANEL SHAKER

FIBERGLASS DOOR

SATIN SMOOTH | WHITE

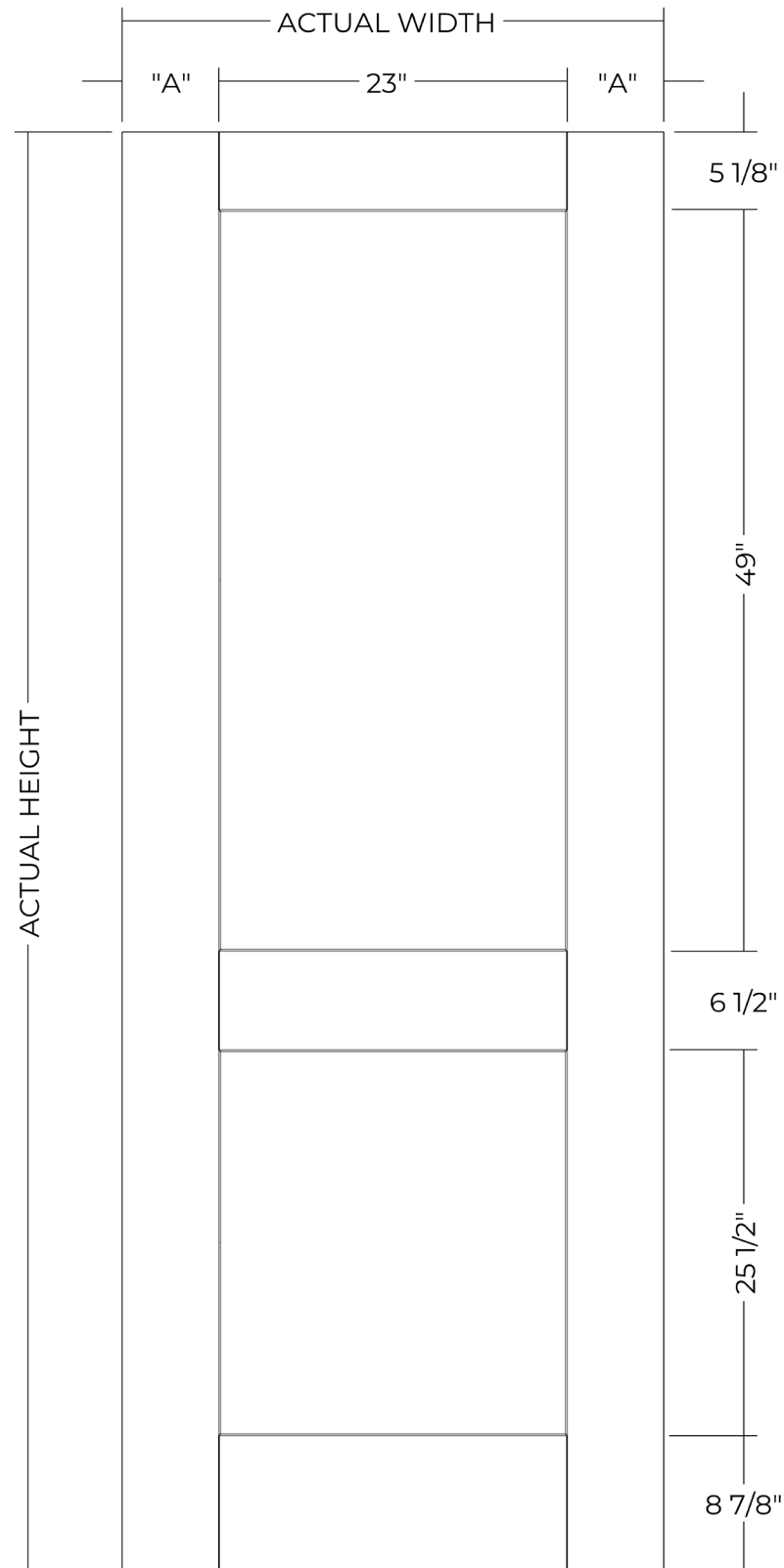

| DOOR WIDTH |         |        |
|------------|---------|--------|
| NOMINAL    | ACTUAL  | "A"    |
| 2-8        | 31 3/4" | 4 3/8" |
| 2-10       | 33 3/4" | 5 3/8" |
| 3-0        | 35 3/4" | 6 3/8" |

| DOOR HEIGHT |        |
|-------------|--------|
| NOMINAL     | ACTUAL |
| 8-0         | 95"    |

| GLASS OPTIONS |         |
|---------------|---------|
| SIZE          | CUTOUT  |
| 22 x 48       | 23 x 49 |
| 22 x 80       | 23 x 81 |

# 8'0" 3 PANEL SHAKER

FIBERGLASS DOOR

SATIN SMOOTH | WHITE

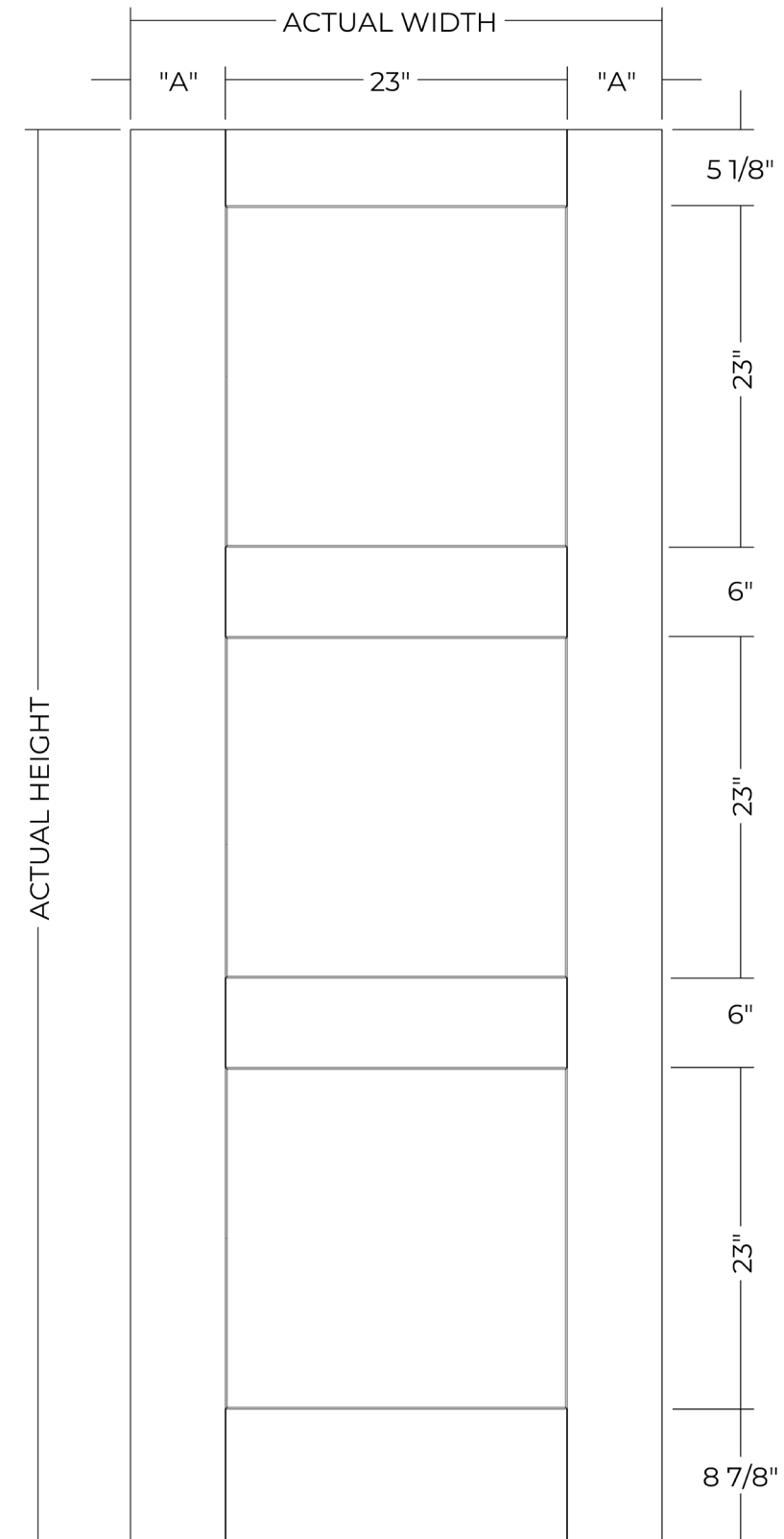

| DOOR WIDTH |         |        |
|------------|---------|--------|
| NOMINAL    | ACTUAL  | "A"    |
| 2-8        | 31 3/4" | 4 3/8" |
| 2-10       | 33 3/4" | 5 3/8" |
| 3-0        | 35 3/4" | 6 3/8" |

| DOOR HEIGHT |        |
|-------------|--------|
| NOMINAL     | ACTUAL |
| 8-0         | 95"    |

| GLASS OPTIONS |         |
|---------------|---------|
| SIZE          | CUTOUT  |
| 22 x 80       | 23 x 81 |

SHAKER

SHAKER

# 8'0" 5 PANEL SHAKER

FIBERGLASS DOOR

SATIN SMOOTH | WHITE

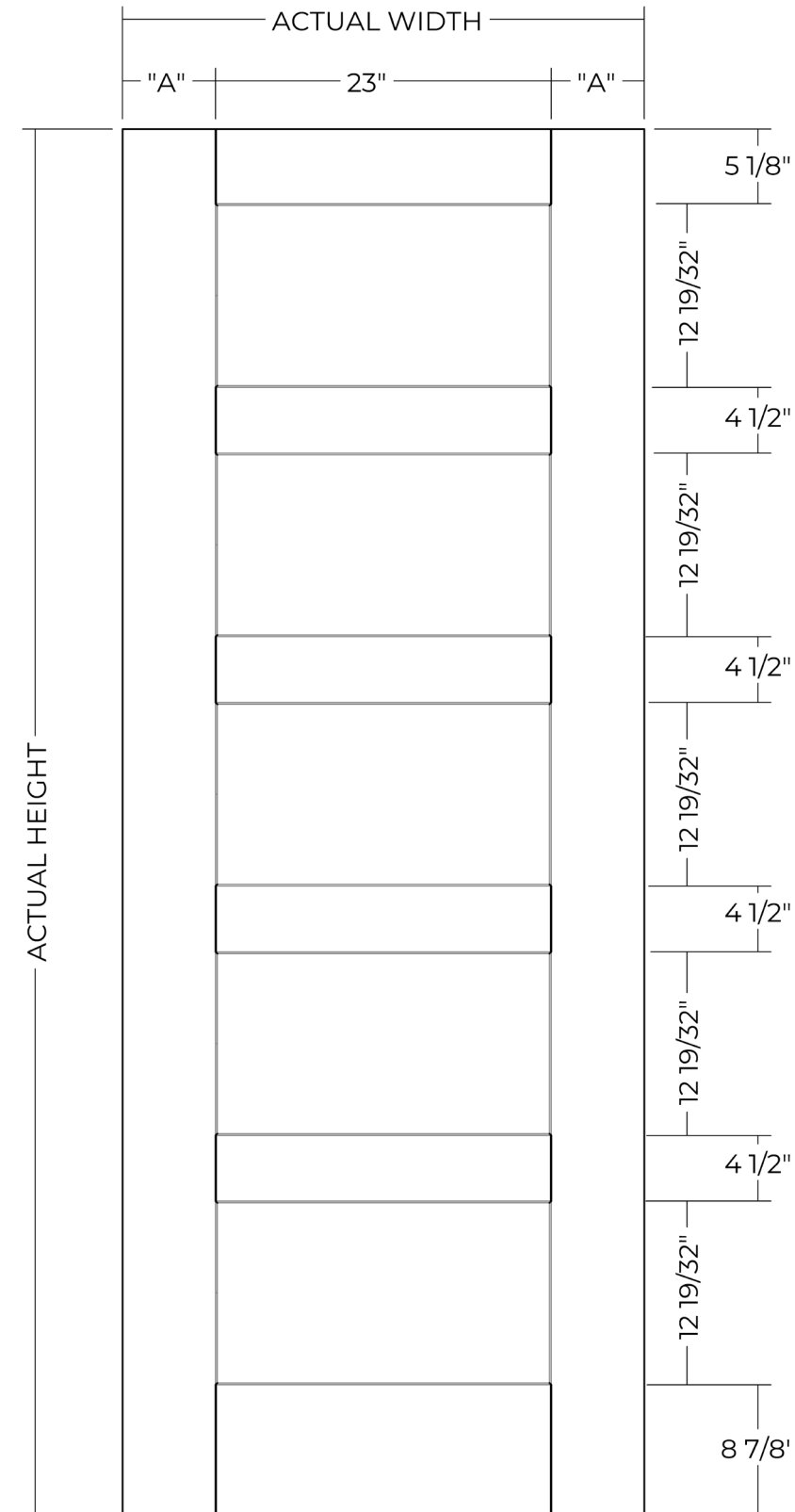

### DOOR WIDTH

| NOMINAL | ACTUAL  | "A"    |
|---------|---------|--------|
| 2-8     | 31 3/4" | 4 3/8" |
| 2-10    | 33 3/4" | 5 3/8" |
| 3-0     | 35 3/4" | 6 3/8" |

### DOOR HEIGHT

| NOMINAL | ACTUAL |
|---------|--------|
| 8-0     | 95"    |

### GLASS OPTIONS

| SIZE    | CUTOUT  |
|---------|---------|
| 22 x 80 | 23 x 81 |

# 8'0" 3 PANEL CRAFTSMAN

FIBERGLASS DOOR

RIFT CUT | TAN | SATIN SMOOTH | WHITE

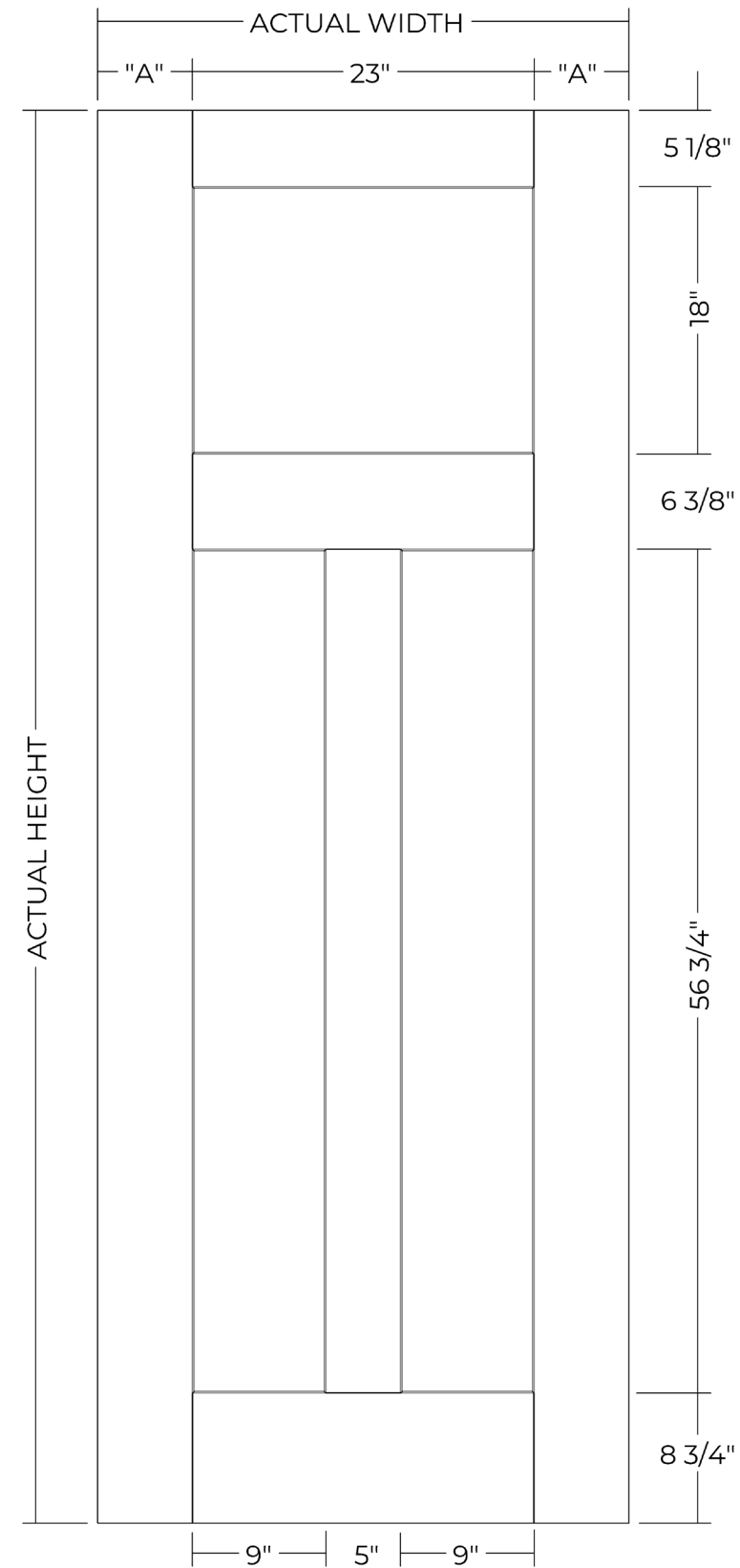

### DOOR WIDTH

| NOMINAL | ACTUAL  | "A"     |
|---------|---------|---------|
| 2-8     | 31 3/4" | 4 5/16" |
| 2-10    | 33 3/4" | 5 5/16" |
| 3-0     | 35 3/4" | 6 5/16" |

### DOOR HEIGHT

| NOMINAL | ACTUAL |
|---------|--------|
| 8-0     | 95"    |

### GLASS OPTIONS

| SIZE    | CUTOUT  |
|---------|---------|
| 22 x 17 | 23 x 18 |
| 22 x 80 | 23 x 81 |

SHAKER

SHAKER

# 8'0" CRAFTSMAN

FIBERGLASS SIDELIGHT

RIFT CUT | TAN

SATIN SMOOTH | WHITE

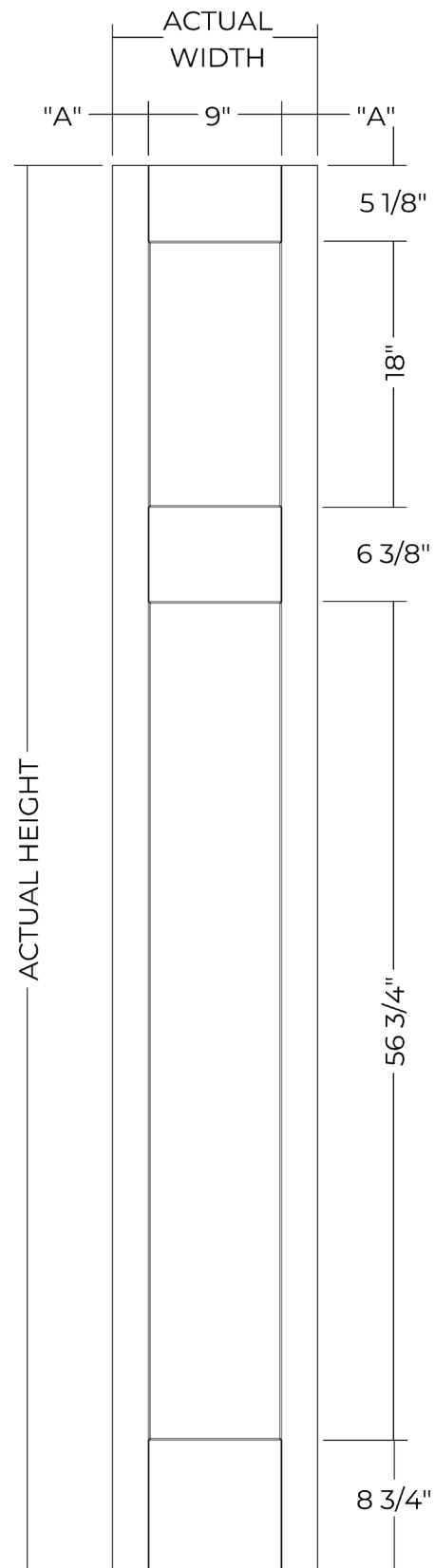

| SIDELIGHT WIDTH |         |          |
|-----------------|---------|----------|
| NOMINAL         | ACTUAL  | "A"      |
| 1-0             | 11 7/8" | 17 1/16" |
| 1-2             | 13 7/8" | 27 1/16" |

| SIDELIGHT HEIGHT |        |
|------------------|--------|
| NOMINAL          | ACTUAL |
| 8-0              | 95"    |

| GLASS OPTIONS |        |
|---------------|--------|
| SIZE          | CUTOUT |
| 8 x 17        | 9 x 18 |
| 8 x 80        | 9 x 81 |

# CONTEMPORARY

FIBERGLASS DOORS



SHAKER

# 6'8" CONTEMPORARY 05

FIBERGLASS DOOR

FINE GRAIN | TAN | SATIN SMOOTH | WHITE

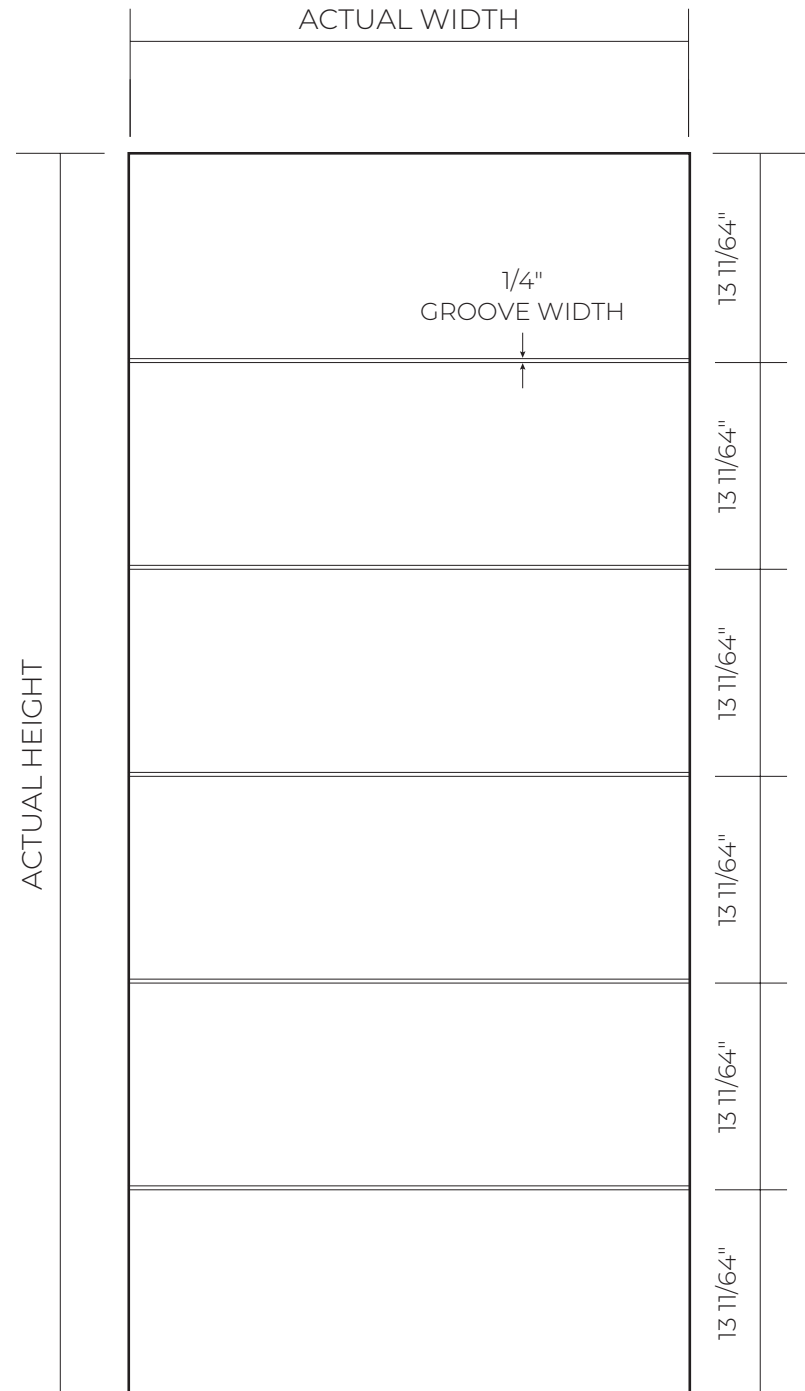

### DOOR WIDTH

| NOMINAL | ACTUAL  |
|---------|---------|
| 2-8     | 31 3/4" |
| 2-10    | 33 3/4" |
| 3-0     | 35 3/4" |
| 3-6     | 41 3/4" |

### DOOR HEIGHT

| NOMINAL | ACTUAL |
|---------|--------|
| 6-8     | 79"    |

Note: The dimension shown are to center line of grooves.

# 6'8" CONTEMPORARY 12

FIBERGLASS DOOR

FINE GRAIN | TAN | SATIN SMOOTH | WHITE

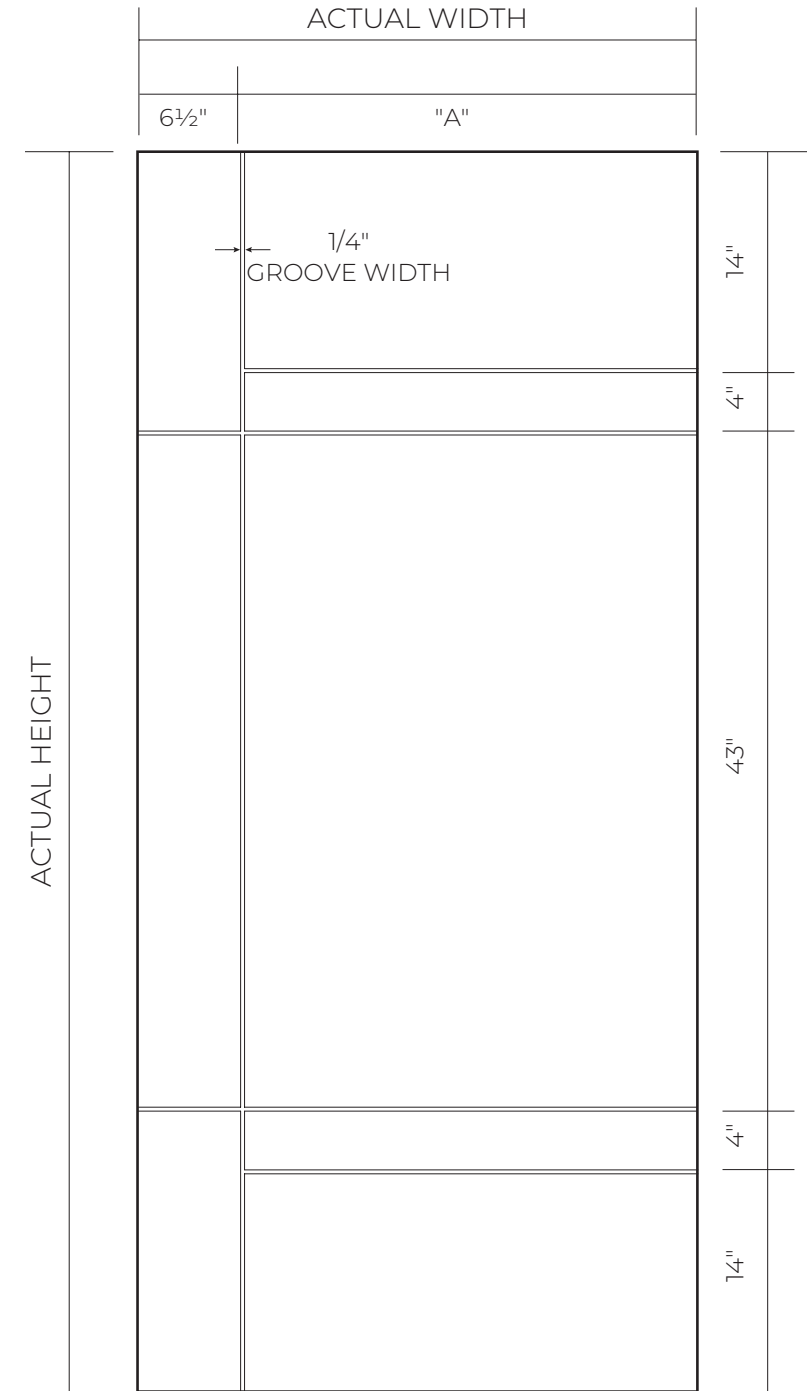

### DOOR WIDTH

| NOMINAL | ACTUAL  | "A"     |
|---------|---------|---------|
| 2-8     | 31 3/4" | 25 1/4" |
| 2-10    | 33 3/4" | 27 1/4" |
| 3-0     | 35 3/4" | 29 1/4" |
| 3-6     | 41 3/4" | 35 1/4" |

### DOOR HEIGHT

| NOMINAL | ACTUAL |
|---------|--------|
| 6-8     | 79"    |

Note: The dimension shown are to center line of grooves.

CONTEMPORARY

CONTEMPORARY

# 6'8" CONTEMPORARY 14

FIBERGLASS DOOR

FINE GRAIN | TAN | SATIN SMOOTH | WHITE

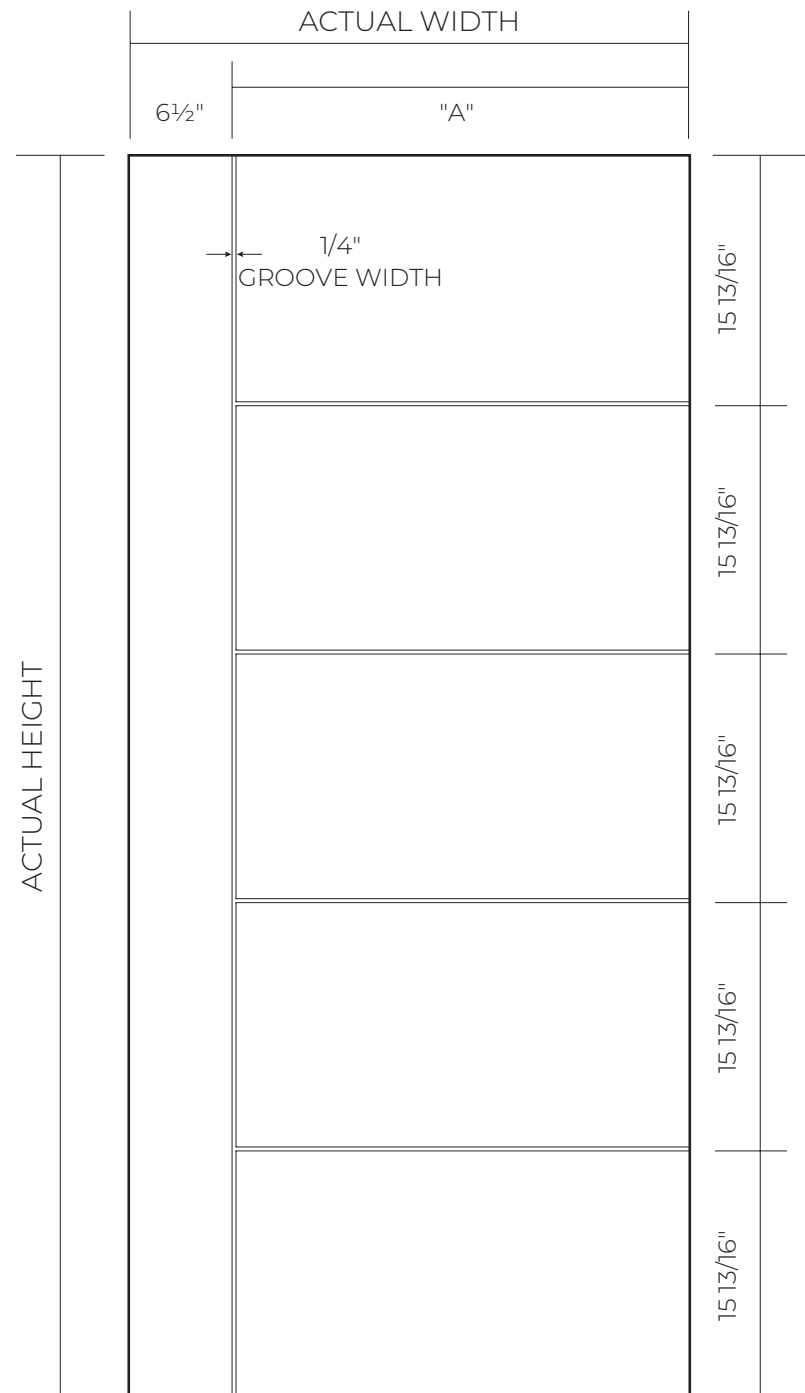

### DOOR WIDTH

| NOMINAL | ACTUAL  | "A"     |
|---------|---------|---------|
| 2-8     | 31 3/4" | 25 1/4" |
| 2-10    | 33 3/4" | 27 1/4" |
| 3-0     | 35 3/4" | 29 1/4" |
| 3-6     | 41 3/4" | 35 1/4" |

### DOOR HEIGHT

| NOMINAL | ACTUAL |
|---------|--------|
| 6-8     | 79"    |

Note: The dimension shown are to center line of grooves.

# 6'8" CONTEMPORARY 16

FIBERGLASS DOOR

FINE GRAIN | TAN | SATIN SMOOTH | WHITE

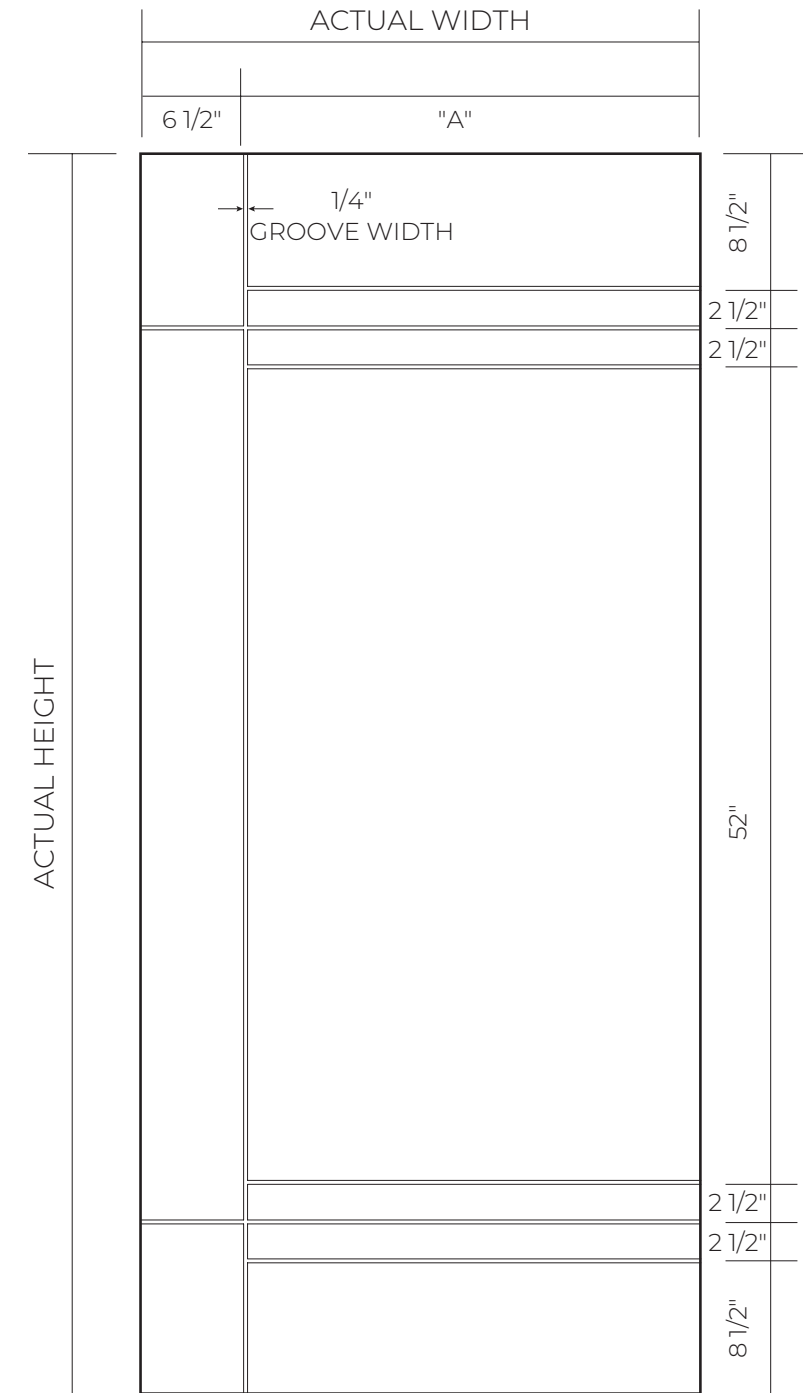

### DOOR WIDTH

| NOMINAL | ACTUAL  | "A"     |
|---------|---------|---------|
| 2-8     | 31 3/4" | 25 1/4" |
| 2-10    | 33 3/4" | 27 1/4" |
| 3-0     | 35 3/4" | 29 1/4" |
| 3-6     | 41 3/4" | 35 1/4" |

### DOOR HEIGHT

| NOMINAL | ACTUAL |
|---------|--------|
| 6-8     | 79"    |

Note: The dimension shown are to center line of grooves.

CONTEMPORARY

ACTUAL HEIGHT

CONTEMPORARY

# 6'8" CONTEMPORARY 24

FIBERGLASS DOOR

FINE GRAIN | TAN

SATIN SMOOTH | WHITE

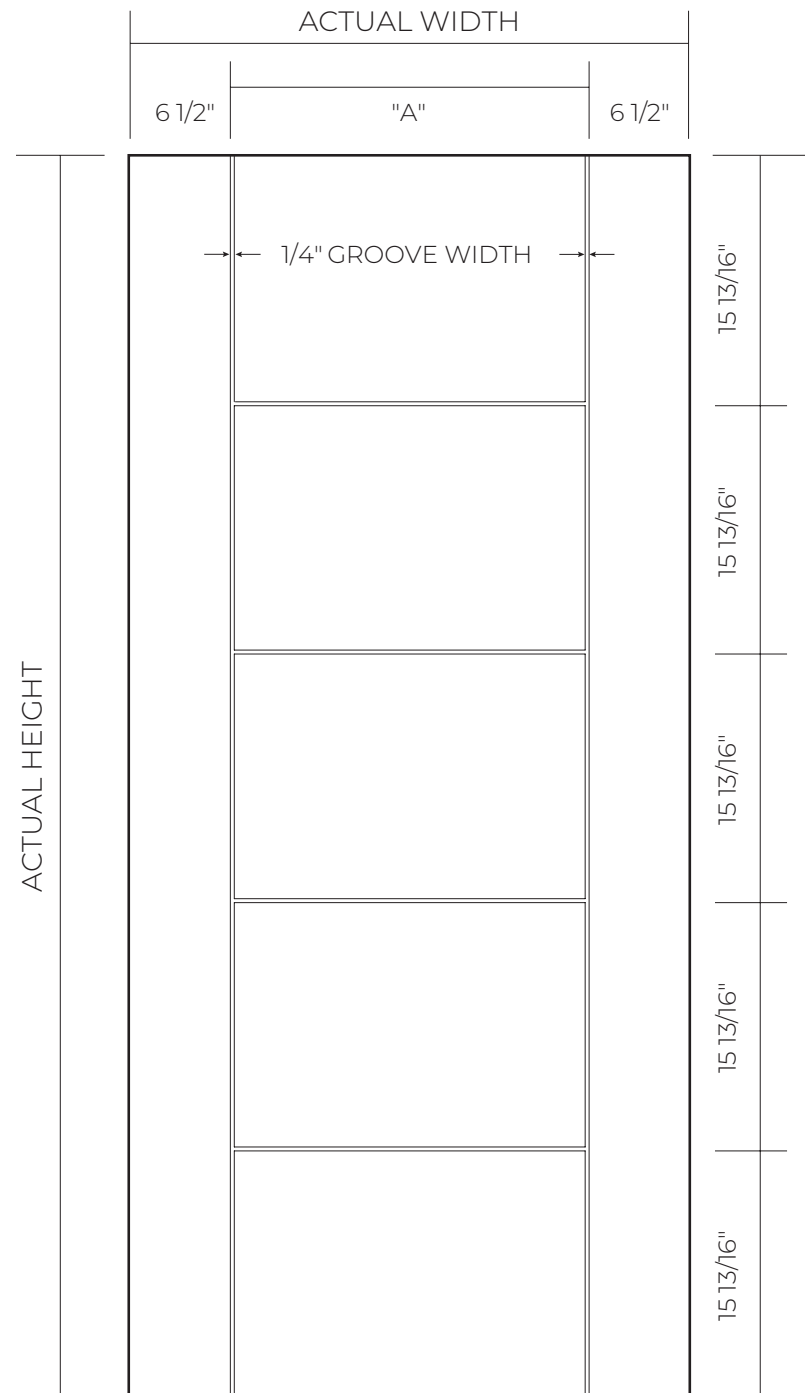

### DOOR WIDTH

| NOMINAL | ACTUAL  | "A"     |
|---------|---------|---------|
| 2-8     | 31 3/4" | 18 3/4" |
| 2-10    | 33 3/4" | 20 3/4" |
| 3-0     | 35 3/4" | 22 3/4" |
| 3-6     | 41 3/4" | 28 3/4" |

### DOOR HEIGHT

| NOMINAL | ACTUAL |
|---------|--------|
| 6-8     | 79"    |

Note: The dimension shown are to center line of grooves.

# 6'8" CONTEMPORARY 29

FIBERGLASS DOOR

FINE GRAIN | TAN

SATIN SMOOTH | WHITE

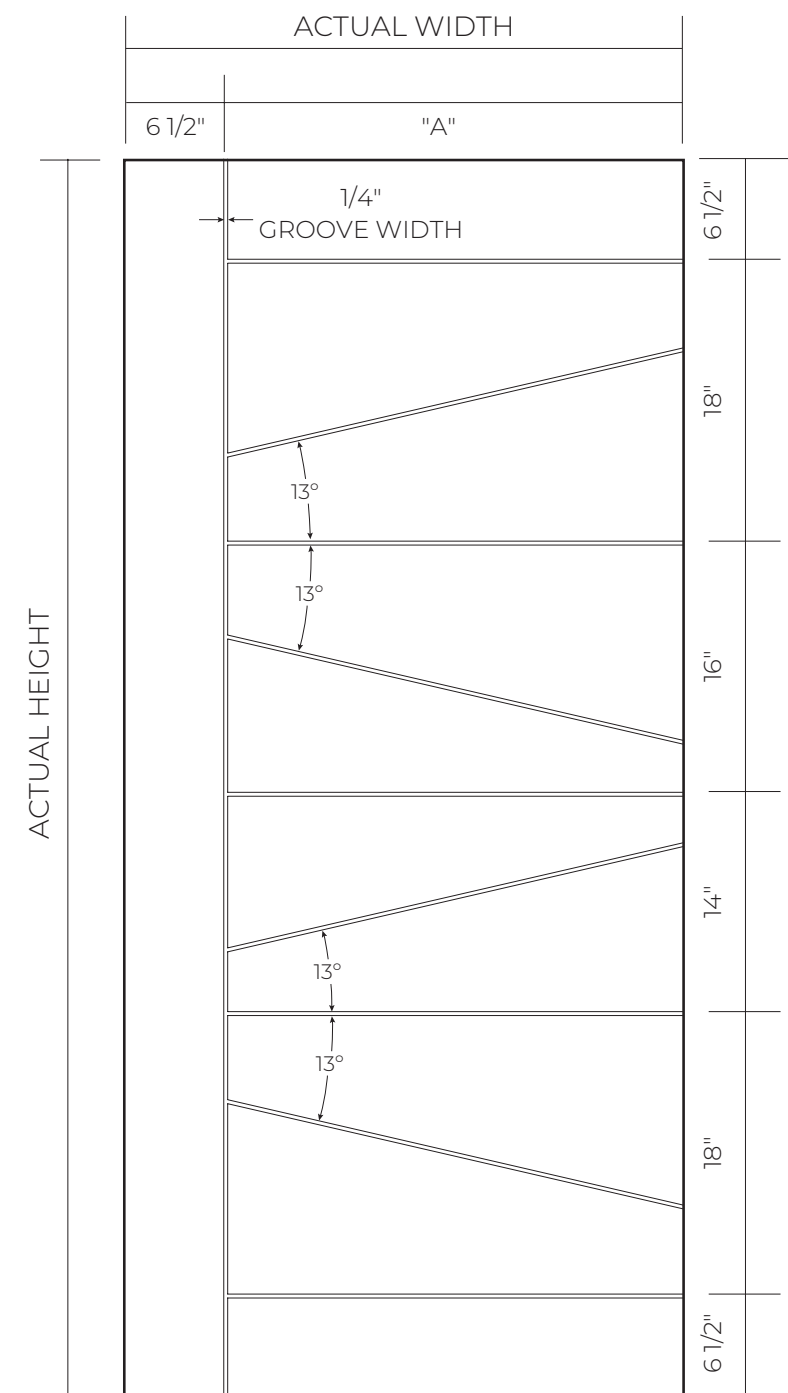

### DOOR WIDTH

| NOMINAL | ACTUAL  | "A"     |
|---------|---------|---------|
| 2-8     | 31 3/4" | 25 1/4" |
| 2-10    | 33 3/4" | 27 1/4" |
| 3-0     | 35 3/4" | 29 1/4" |
| 3-6     | 41 3/4" | 35 1/4" |

### DOOR HEIGHT

| NOMINAL | ACTUAL |
|---------|--------|
| 6-8     | 79"    |

Note: The dimension shown are to center line of grooves.

CONTEMPORARY  
ACTUAL HEIGHT

CONTEMPORARY  
ACTUAL HEIGHT

# 6'8" CONTEMPORARY 30

FIBERGLASS DOOR

FINE GRAIN | TAN

SATIN SMOOTH | WHITE

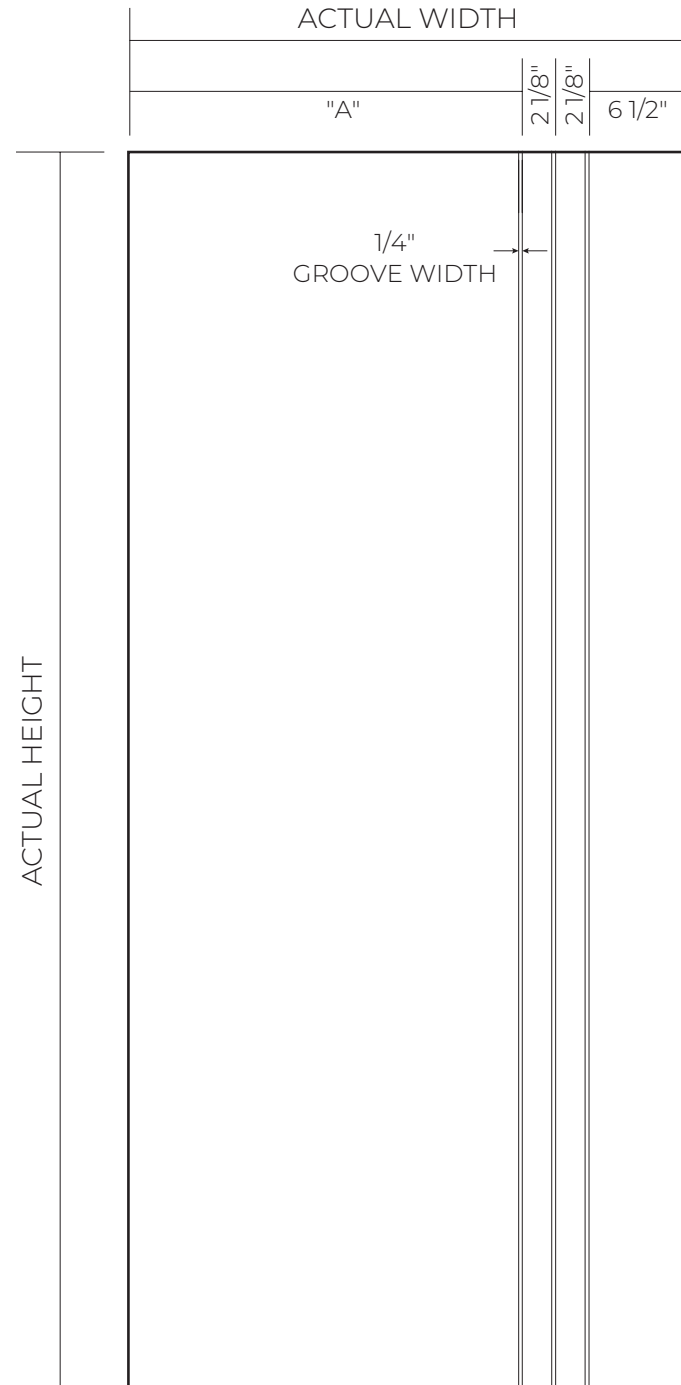

### DOOR WIDTH

| NOMINAL | ACTUAL  | "A" |
|---------|---------|-----|
| 2-8     | 31 3/4" | 21" |
| 2-10    | 33 3/4" | 23" |
| 3-0     | 35 3/4" | 25" |
| 3-6     | 41 3/4" | 31" |

### DOOR HEIGHT

| NOMINAL | ACTUAL |
|---------|--------|
| 6-8     | 79"    |

Note: The dimension shown are to center line of grooves.

# 6'8" CONTEMPORARY 60

FIBERGLASS DOOR

FINE GRAIN | TAN

SATIN SMOOTH | WHITE

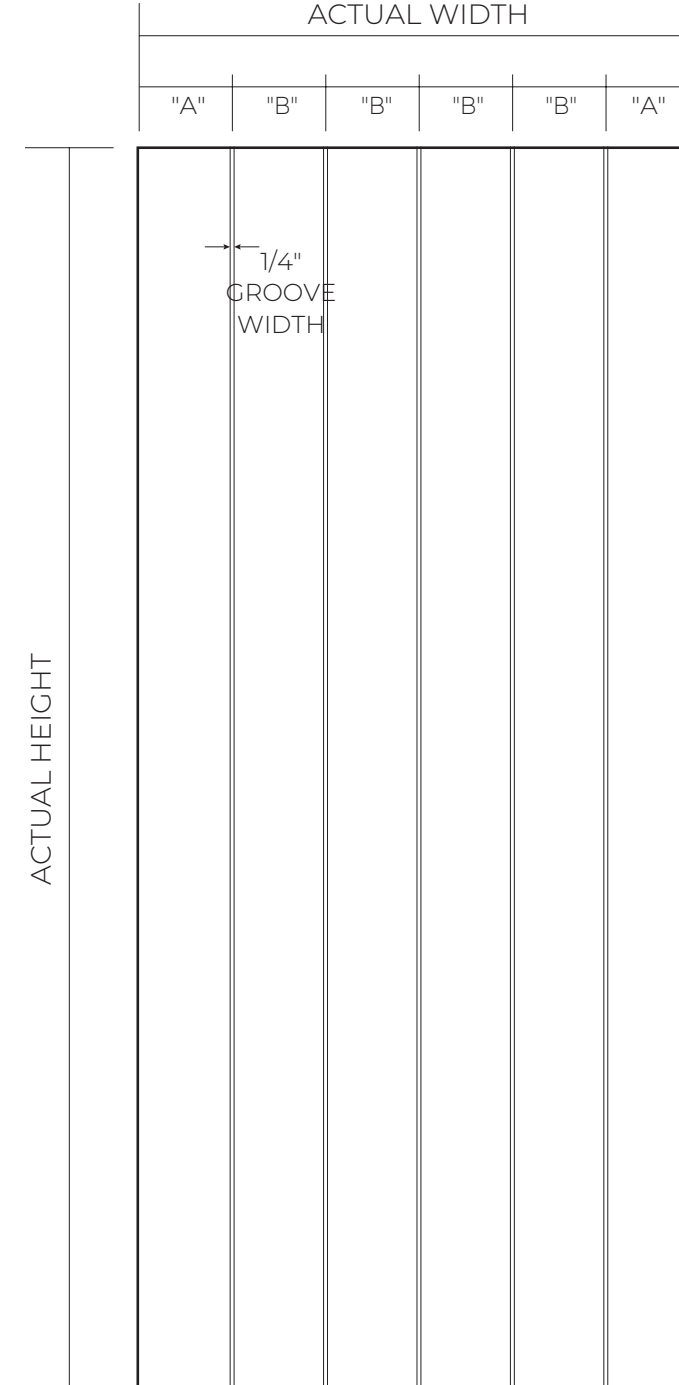

### DOOR WIDTH

| NOMINAL | ACTUAL  | "A"    | "B"      |
|---------|---------|--------|----------|
| 2-8     | 31 3/4" | 5 3/8" | 5 1/4"   |
| 2-10    | 33 3/4" | 5 5/8" | 5 5/8"   |
| 3-0     | 35 3/4" | 6"     | 5 15/16" |
| 3-6     | 41 3/4" | 7"     | 6 15/16" |

### DOOR HEIGHT

| NOMINAL | ACTUAL |
|---------|--------|
| 6-8     | 79"    |

Note: The dimension shown are to center line of grooves.

CONTEMPORARY

ACTUAL HEIGHT

CONTEMPORARY

ACTUAL HEIGHT



# 8'0" CONTEMPORARY 05

FIBERGLASS DOOR

FINE GRAIN | TAN | SATIN SMOOTH | WHITE

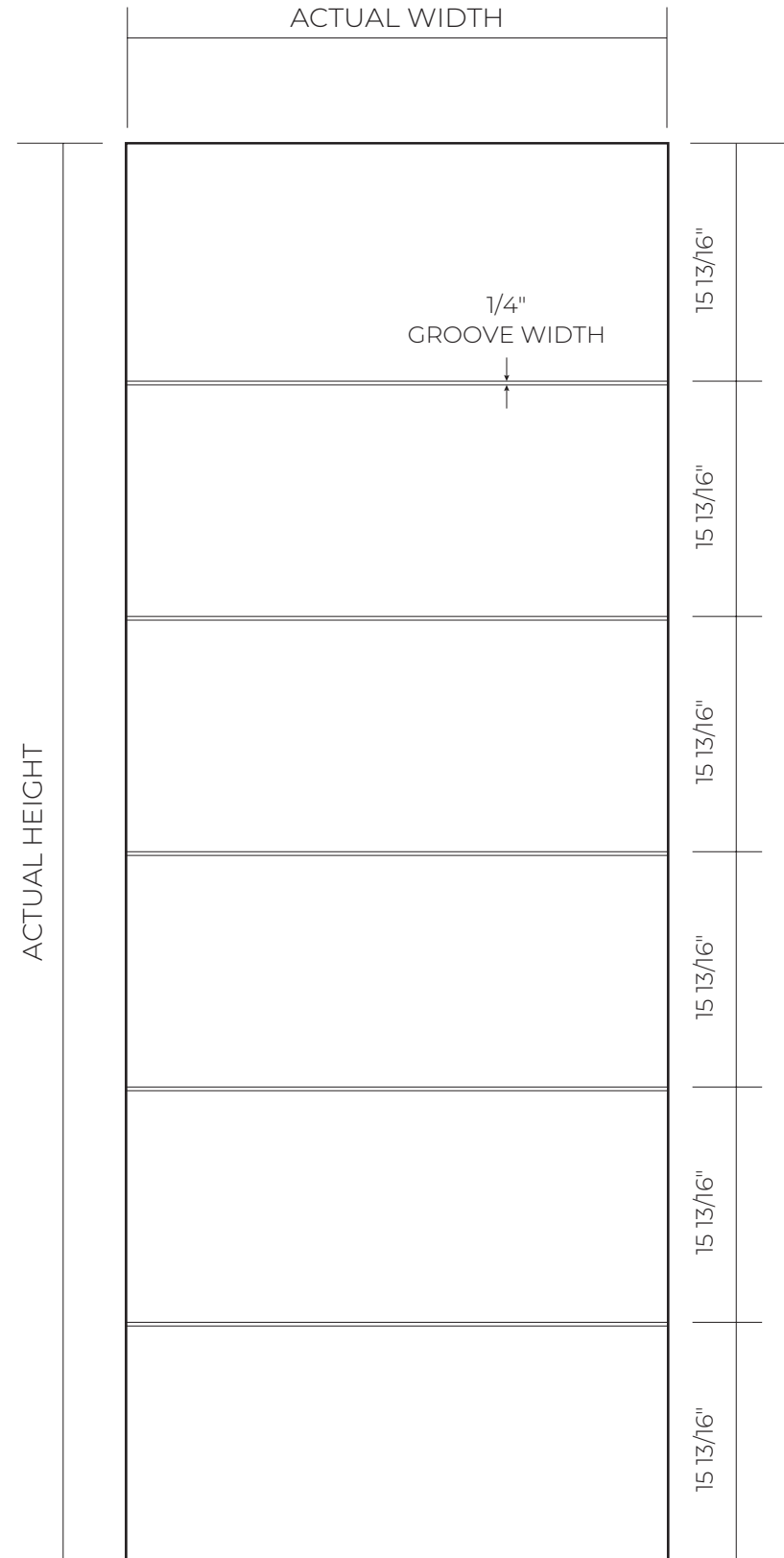

### DOOR WIDTH

| NOMINAL | ACTUAL  |
|---------|---------|
| 2-8     | 31 3/4" |
| 2-10    | 33 3/4" |
| 3-0     | 35 3/4" |
| 3-6     | 41 3/4" |

### DOOR HEIGHT

| NOMINAL | ACTUAL |
|---------|--------|
| 8-0     | 95"    |

Note: The dimension shown are to center line of grooves.

# 8'0" CONTEMPORARY 12

FIBERGLASS DOOR

FINE GRAIN | TAN | SATIN SMOOTH | WHITE

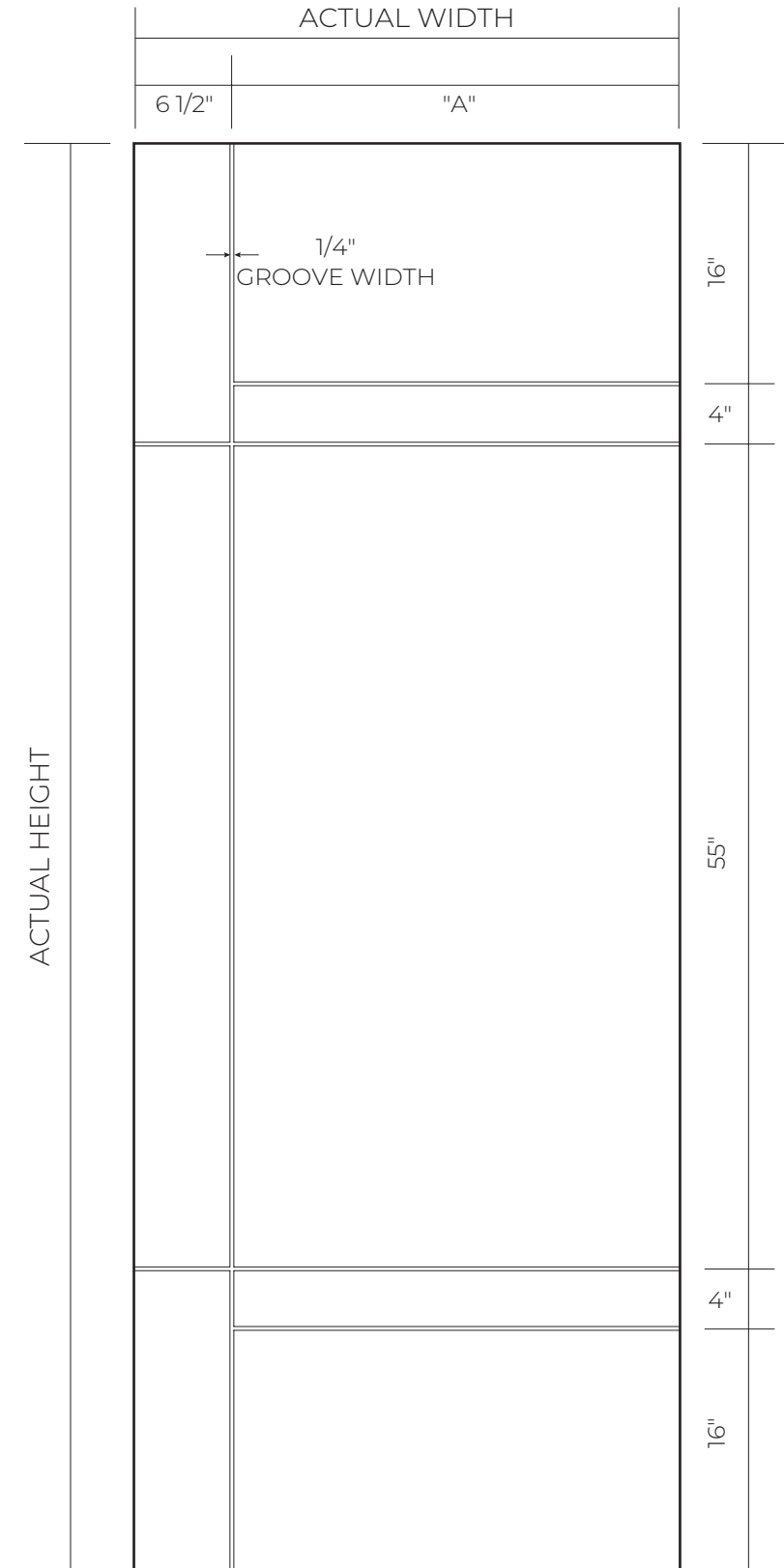

### DOOR WIDTH

| NOMINAL | ACTUAL  | "A"     |
|---------|---------|---------|
| 2-8     | 31 3/4" | 25 1/4" |
| 2-10    | 33 3/4" | 27 1/4" |
| 3-0     | 35 3/4" | 29 1/4" |
| 3-6     | 41 3/4" | 35 1/4" |

### DOOR HEIGHT

| NOMINAL | ACTUAL |
|---------|--------|
| 8-0     | 95"    |

Note: The dimension shown are to center line of grooves.

CONTEMPORARY

CONTEMPORARY

# 8'0" CONTEMPORARY 14

FIBERGLASS DOOR

FINE GRAIN | TAN | SATIN SMOOTH | WHITE

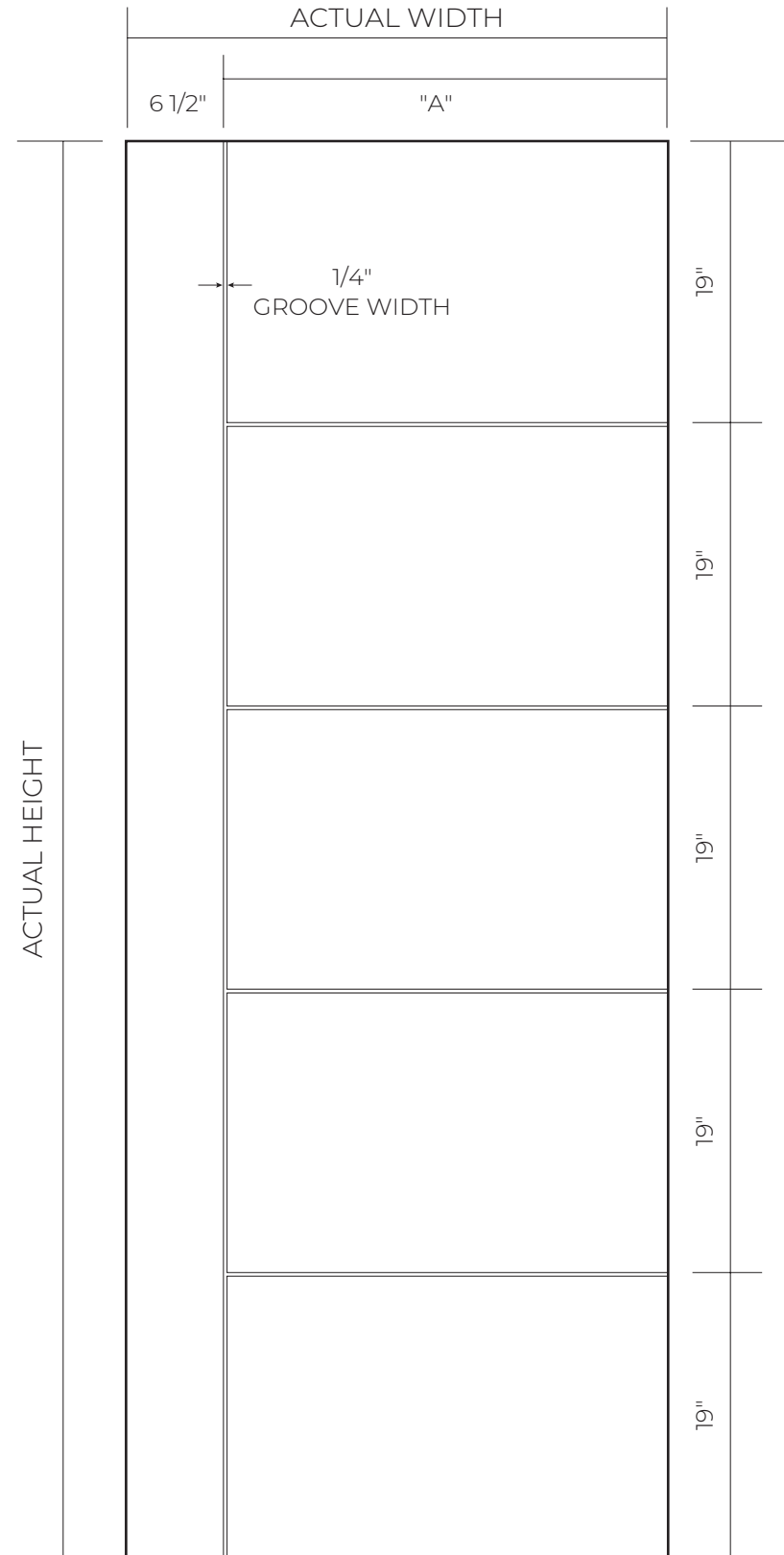

### DOOR WIDTH

| NOMINAL | ACTUAL  | "A"     |
|---------|---------|---------|
| 2-8     | 31 3/4" | 25 1/4" |
| 2-10    | 33 3/4" | 27 1/4" |
| 3-0     | 35 3/4" | 29 1/4" |
| 3-6     | 41 3/4" | 35 1/4" |

### DOOR HEIGHT

| NOMINAL | ACTUAL |
|---------|--------|
| 8-0     | 95"    |

Note: The dimension shown are to center line of grooves.

# 8'0" CONTEMPORARY 16

FIBERGLASS DOOR

FINE GRAIN | TAN | SATIN SMOOTH | WHITE

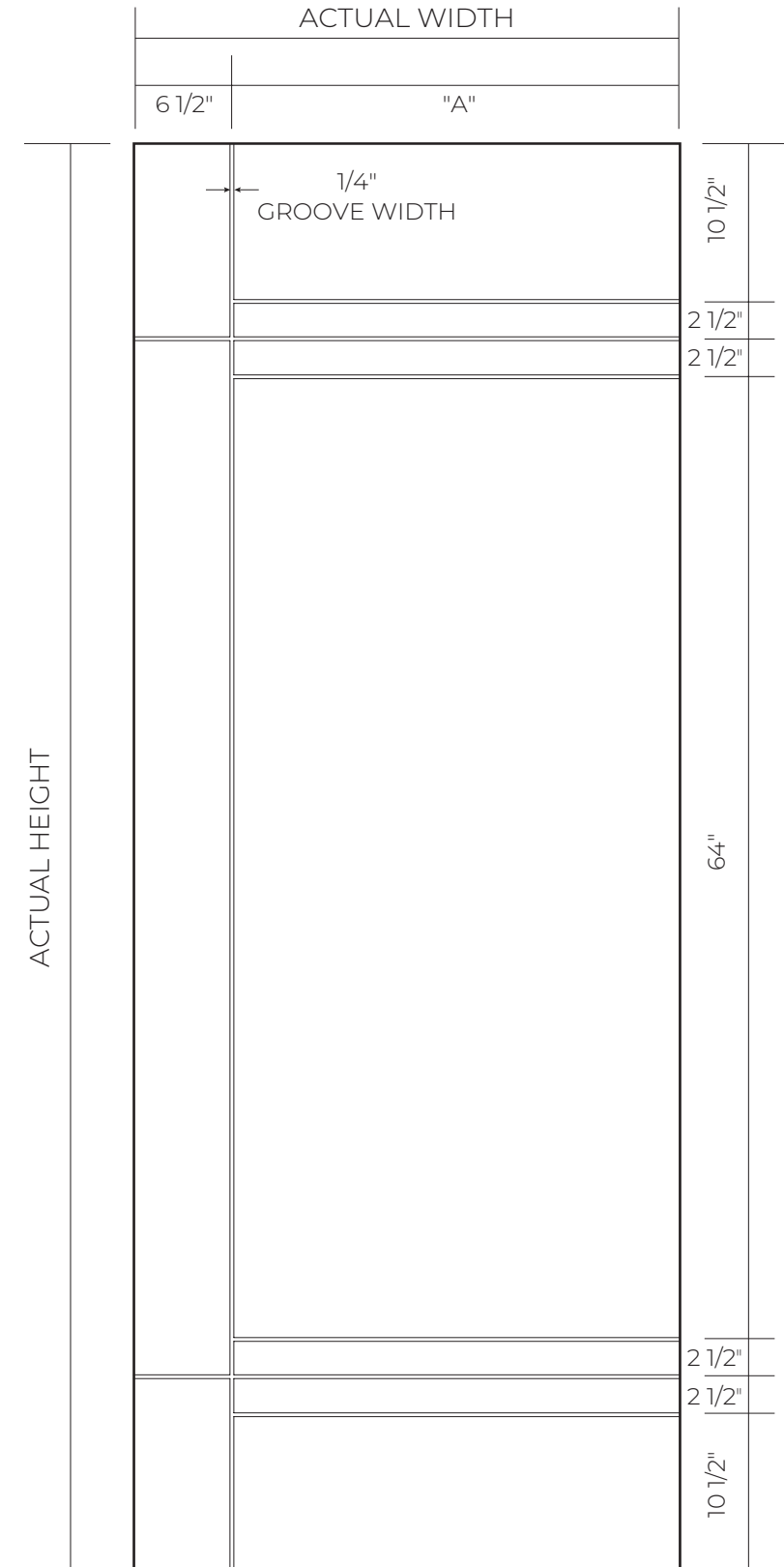

### DOOR WIDTH

| NOMINAL | ACTUAL  | "A"     |
|---------|---------|---------|
| 2-8     | 31 3/4" | 25 1/4" |
| 2-10    | 33 3/4" | 27 1/4" |
| 3-0     | 35 3/4" | 29 1/4" |
| 3-6     | 41 3/4" | 35 1/4" |

### DOOR HEIGHT

| NOMINAL | ACTUAL |
|---------|--------|
| 8-0     | 95"    |

Note: The dimension shown are to center line of grooves.

CONTEMPORARY

CONTEMPORARY

# 8'0" CONTEMPORARY 24

FIBERGLASS DOOR

FINE GRAIN | TAN | SATIN SMOOTH | WHITE

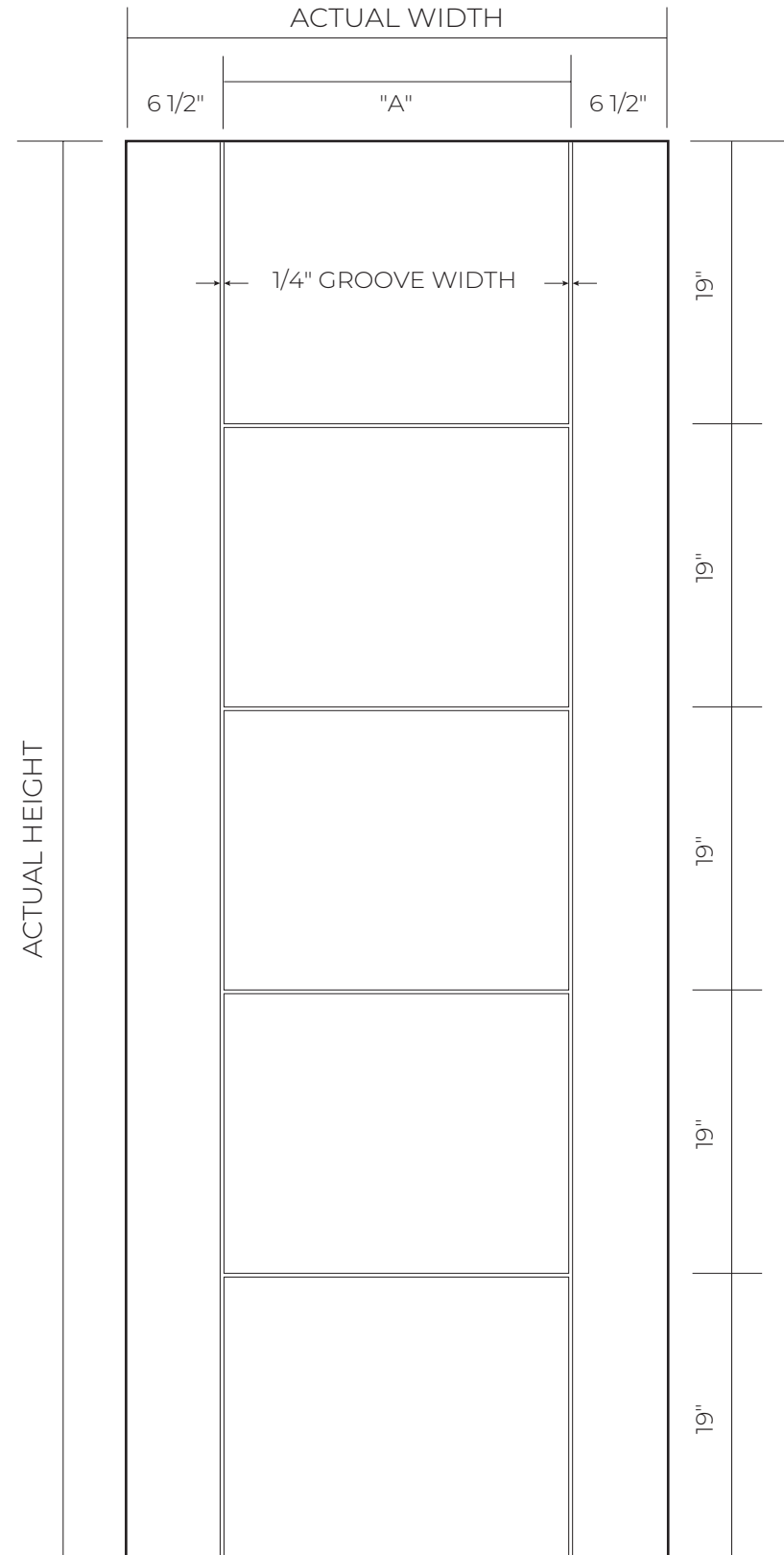

### DOOR WIDTH

| NOMINAL | ACTUAL  | "A"     |
|---------|---------|---------|
| 2-8     | 31 3/4" | 18 3/4" |
| 2-10    | 33 3/4" | 20 3/4" |
| 3-0     | 35 3/4" | 22 3/4" |
| 3-6     | 41 3/4" | 28 3/4" |

### DOOR HEIGHT

| NOMINAL | ACTUAL |
|---------|--------|
| 8-0     | 95"    |

Note: The dimension shown are to center line of grooves.

# 8'0" CONTEMPORARY 29

FIBERGLASS DOOR

FINE GRAIN | TAN | SATIN SMOOTH | WHITE

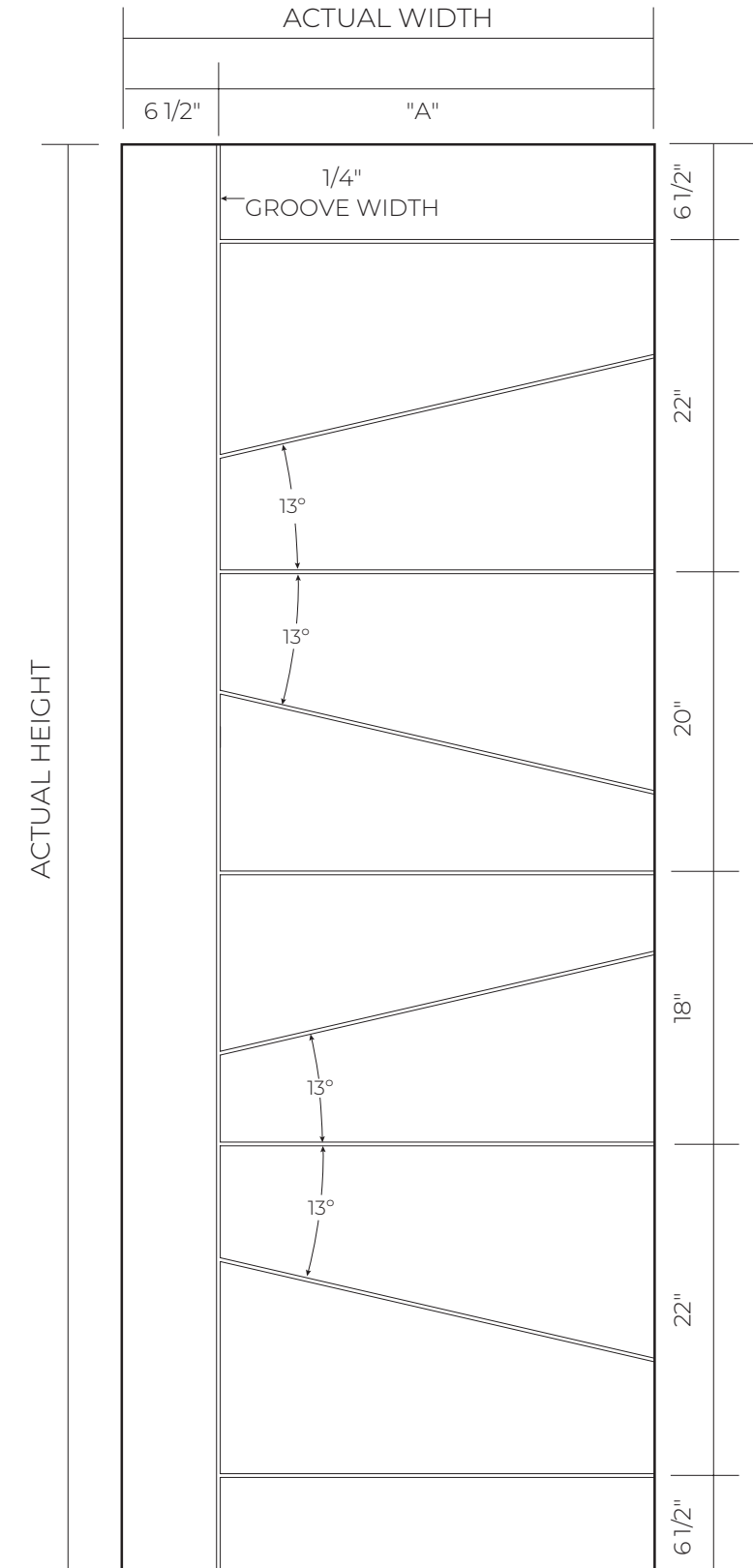

### DOOR WIDTH

| NOMINAL | ACTUAL  | "A"     |
|---------|---------|---------|
| 2-8     | 31 3/4" | 25 1/4" |
| 2-10    | 33 3/4" | 27 1/4" |
| 3-0     | 35 3/4" | 29 1/4" |
| 3-6     | 41 3/4" | 35 1/4" |

### DOOR HEIGHT

| NOMINAL | ACTUAL |
|---------|--------|
| 8-0     | 95"    |

Note: The dimension shown are to center line of grooves.

CONTEMPORARY

ACTUAL HEIGHT

CONTEMPORARY

ACTUAL HEIGHT

# 8'0" CONTEMPORARY 30

FIBERGLASS DOOR

FINE GRAIN | TAN

SATIN SMOOTH | WHITE

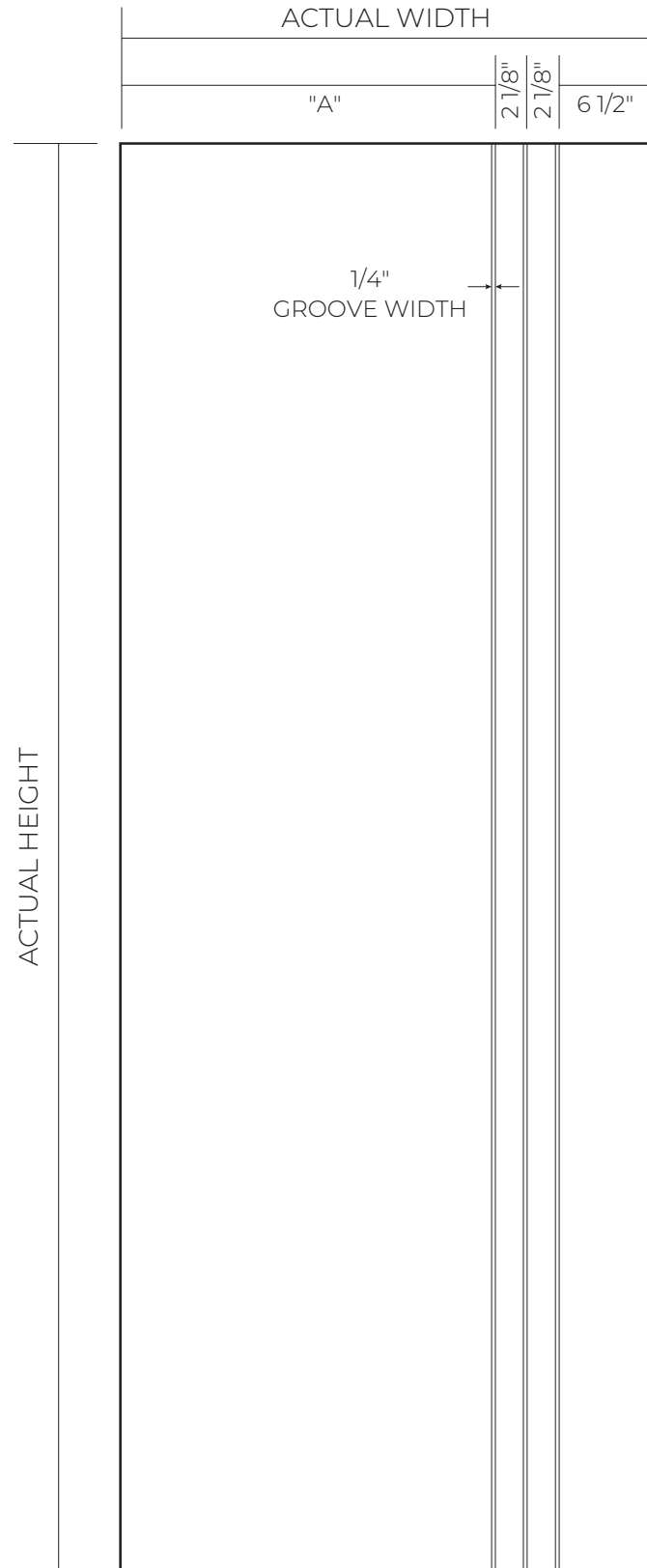

### DOOR WIDTH

| NOMINAL | ACTUAL  | "A" |
|---------|---------|-----|
| 2-8     | 31 3/4" | 21" |
| 2-10    | 33 3/4" | 23" |
| 3-0     | 35 3/4" | 25" |
| 3-6     | 41 3/4" | 31" |

### DOOR HEIGHT

| NOMINAL | ACTUAL |
|---------|--------|
| 8-0     | 95"    |

Note: The dimension shown are to center line of grooves.

# 8'0" CONTEMPORARY 60

FIBERGLASS DOOR

FINE GRAIN | TAN

SATIN SMOOTH | WHITE

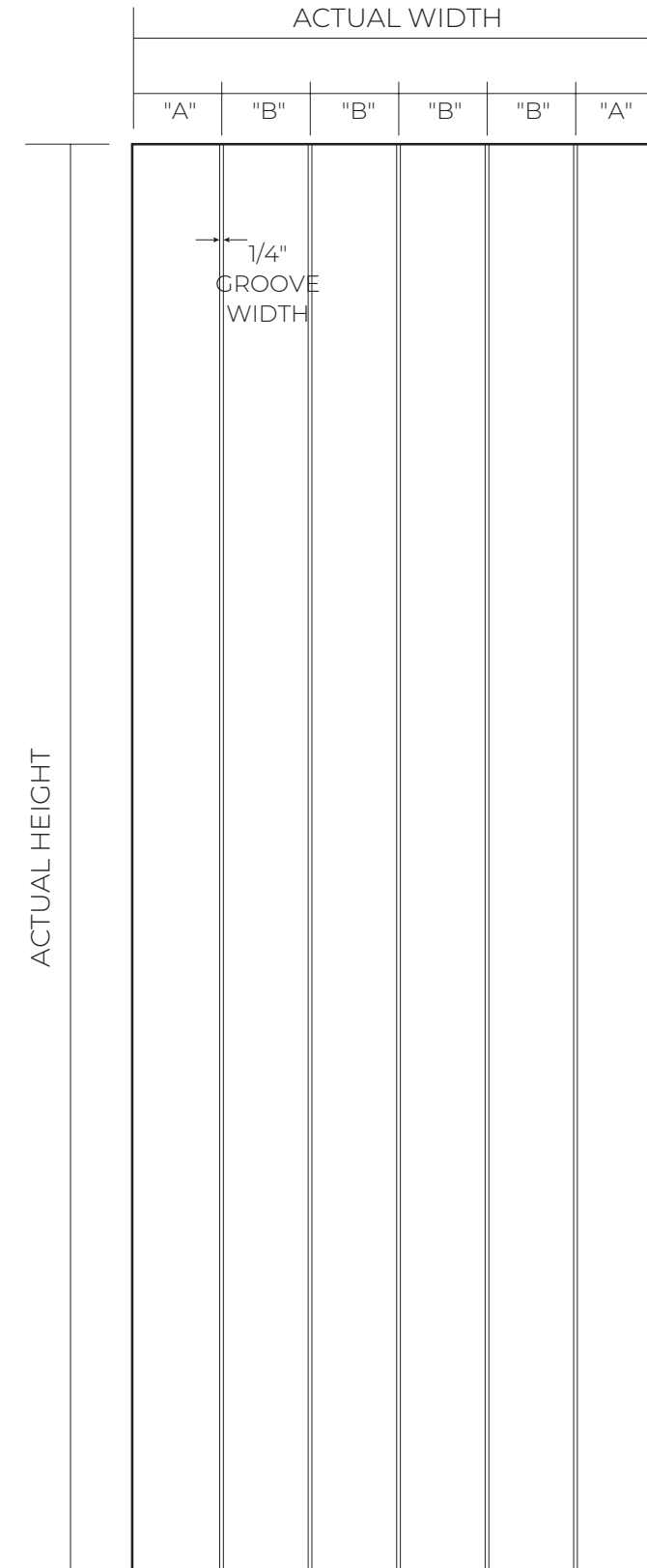

### DOOR WIDTH

| NOMINAL | ACTUAL  | "A"    | "B"      |
|---------|---------|--------|----------|
| 2-8     | 31 3/4" | 5 3/8" | 5 1/4"   |
| 2-10    | 33 3/4" | 5 5/8" | 5 5/8"   |
| 3-0     | 35 3/4" | 6"     | 5 15/16" |
| 3-6     | 41 3/4" | 7"     | 6 15/16" |

### DOOR HEIGHT

| NOMINAL | ACTUAL |
|---------|--------|
| 8-0     | 95"    |

Note: The dimension shown are to center line of grooves.

CONTEMPORARY

CONTEMPORARY

# ESTATE FLUSH GLAZED

FIBERGLASS DOORS AND SIDELIGHTS

# 6'8" 1 LIGHT

FIBERGLASS DOOR

RIFT CUT | TAN | SATIN SMOOTH | WHITE

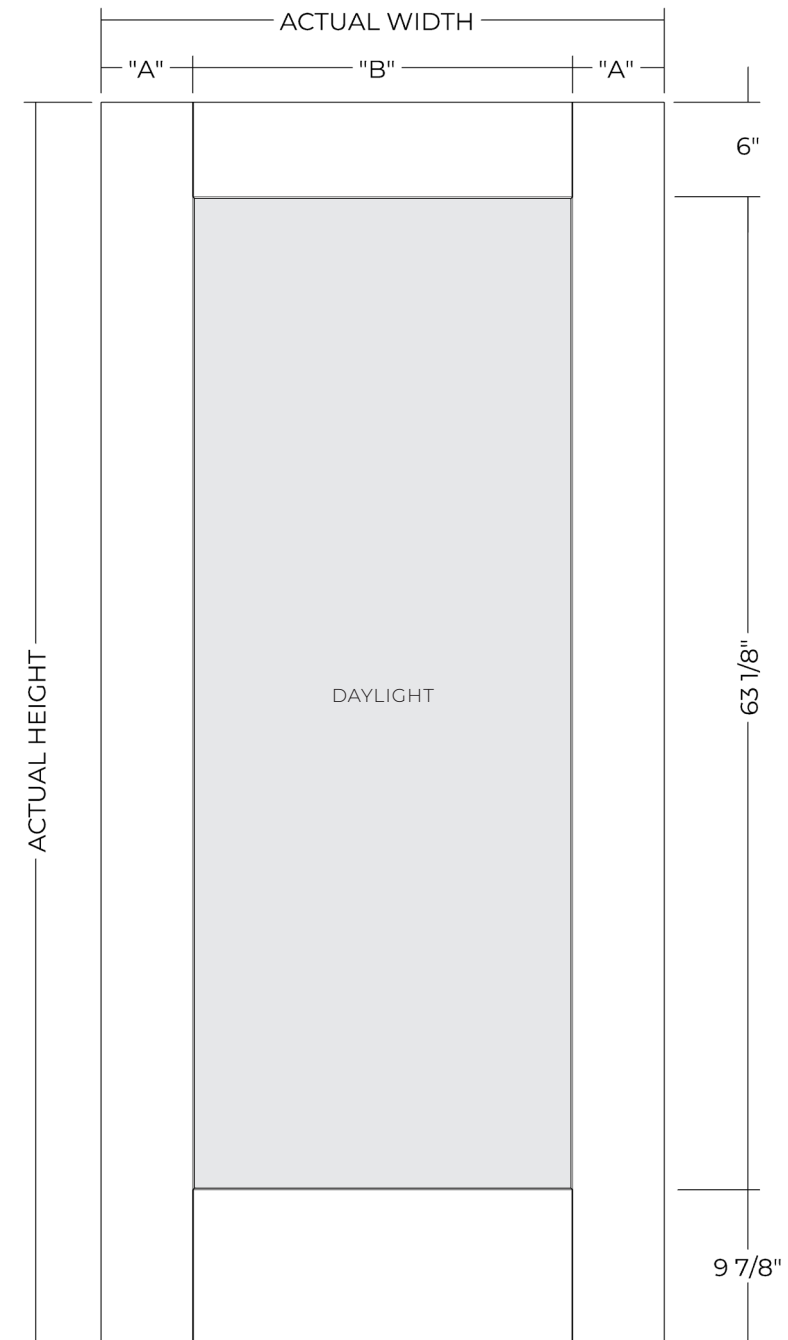

| DOOR WIDTH - 20 X 64 GLASS SIZE |         |         |         |
|---------------------------------|---------|---------|---------|
| NOMINAL                         | ACTUAL  | "A"     | "B"     |
| 2-6                             | 29 3/4" | 4 5/16" | 19 1/8" |

| DOOR HEIGHT |        |
|-------------|--------|
| NOMINAL     | ACTUAL |
| 6-8         | 79"    |

| GLASS SPECIFICATIONS |                 |
|----------------------|-----------------|
| SIZE                 | DAYLIGHT        |
| 20 x 64              | 18 7/8 x 62 7/8 |

| DOOR WIDTH - 22 X 64 GLASS SIZE |         |         |         |
|---------------------------------|---------|---------|---------|
| NOMINAL                         | ACTUAL  | "A"     | "B"     |
| 2-8                             | 31 3/4" | 5 7/16" | 21 1/8" |
| 2-10                            | 33 3/4" | 6 5/16" | 21 1/8" |
| 3-0                             | 35 3/4" | 7 5/16" | 21 1/8" |

| DOOR HEIGHT |        |
|-------------|--------|
| NOMINAL     | ACTUAL |
| 6-8         | 79"    |

| GLASS SPECIFICATIONS |                 |
|----------------------|-----------------|
| SIZE                 | DAYLIGHT        |
| 22 x 64              | 20 7/8 x 62 7/8 |

| DOOR WIDTH - 25 X 64 GLASS SIZE |         |          |         |
|---------------------------------|---------|----------|---------|
| NOMINAL                         | ACTUAL  | "A"      | "B"     |
| 2-10                            | 33 3/4" | 4 13/16" | 24 1/8" |
| 3-0                             | 35 3/4" | 5 13/16" | 24 1/8" |

| DOOR HEIGHT |        |
|-------------|--------|
| NOMINAL     | ACTUAL |
| 6-8         | 79"    |

| GLASS SPECIFICATIONS |                 |
|----------------------|-----------------|
| SIZE                 | DAYLIGHT        |
| 25 x 64              | 23 7/8 x 62 7/8 |

ESTATE FLUSH GLAZED

# 6'8" 1 LIGHT NARROW

FIBERGLASS DOOR

RIFT CUT | TAN | SATIN SMOOTH | WHITE

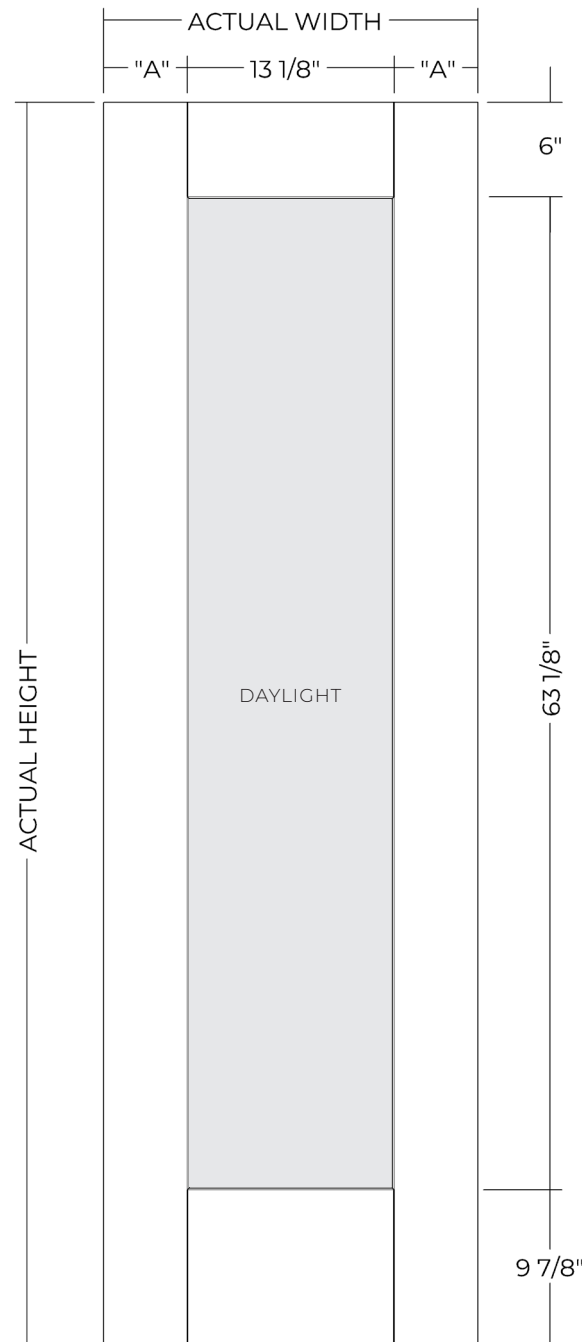

| DOOR WIDTH |         |         |
|------------|---------|---------|
| NOMINAL    | ACTUAL  | "A"     |
| 2-0        | 23 3/4" | 5 5/16" |

| DOOR HEIGHT |        |
|-------------|--------|
| NOMINAL     | ACTUAL |
| 6-8         | 79"    |

  

| GLASS SPECIFICATIONS |                 |
|----------------------|-----------------|
| SIZE                 | DAYLIGHT        |
| 14 x 64              | 12 7/8 x 62 7/8 |

# 6'8" 3/4 LIGHT ESTATE

FIBERGLASS DOOR

RIFT CUT | TAN | SATIN SMOOTH | WHITE

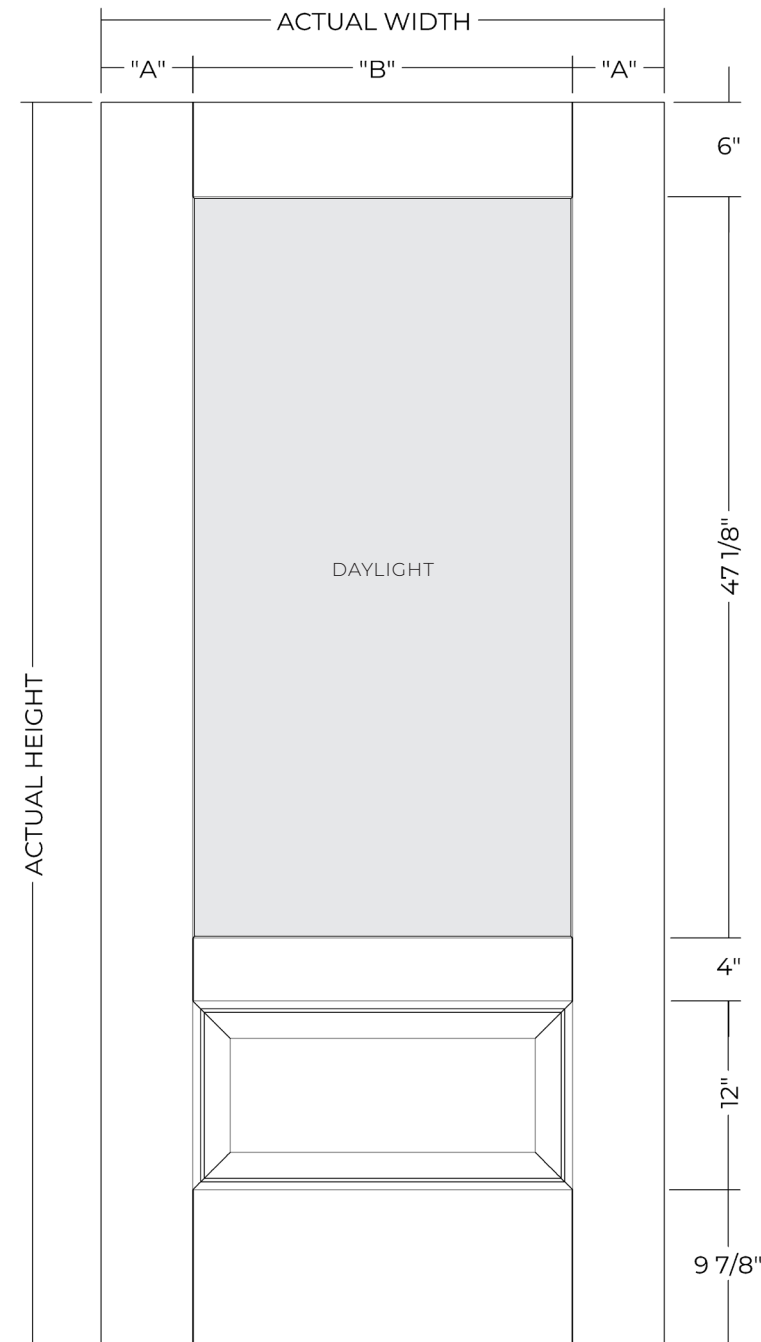

| DOOR WIDTH - 20 X 48 GLASS SIZE |         |         |         |
|---------------------------------|---------|---------|---------|
| NOMINAL                         | ACTUAL  | "A"     | "B"     |
| 2-6                             | 29 3/4" | 5 5/16" | 19 1/8" |
| 2-8                             | 31 3/4" | 5 5/16" | 19 1/8" |

| DOOR HEIGHT |        |
|-------------|--------|
| NOMINAL     | ACTUAL |
| 6-8         | 79"    |

| GLASS SPECIFICATIONS |                 |
|----------------------|-----------------|
| SIZE                 | DAYLIGHT        |
| 20 x 48              | 18 7/8 x 46 7/8 |

| DOOR WIDTH - 25 X 48 GLASS SIZE |         |          |         |
|---------------------------------|---------|----------|---------|
| NOMINAL                         | ACTUAL  | "A"      | "B"     |
| 2-10                            | 33 3/4" | 4 13/16" | 24 1/8" |
| 3-0                             | 35 3/4" | 5 13/16" | 24 1/8" |

| DOOR HEIGHT |        |
|-------------|--------|
| NOMINAL     | ACTUAL |
| 6-8         | 79"    |

| GLASS SPECIFICATIONS |                 |
|----------------------|-----------------|
| SIZE                 | DAYLIGHT        |
| 25 x 48              | 23 7/8 x 46 7/8 |

Note: The dimension shown from bottom of door to bottom of embossment is 1/4" larger on 79 1/4" and 95 1/4" doors.

ESTATE FLUSH GLAZED

ESTATE FLUSH GLAZED

# 6'8" CRAFTSMAN PLANK

FIBERGLASS DOOR

SATIN SMOOTH | WHITE

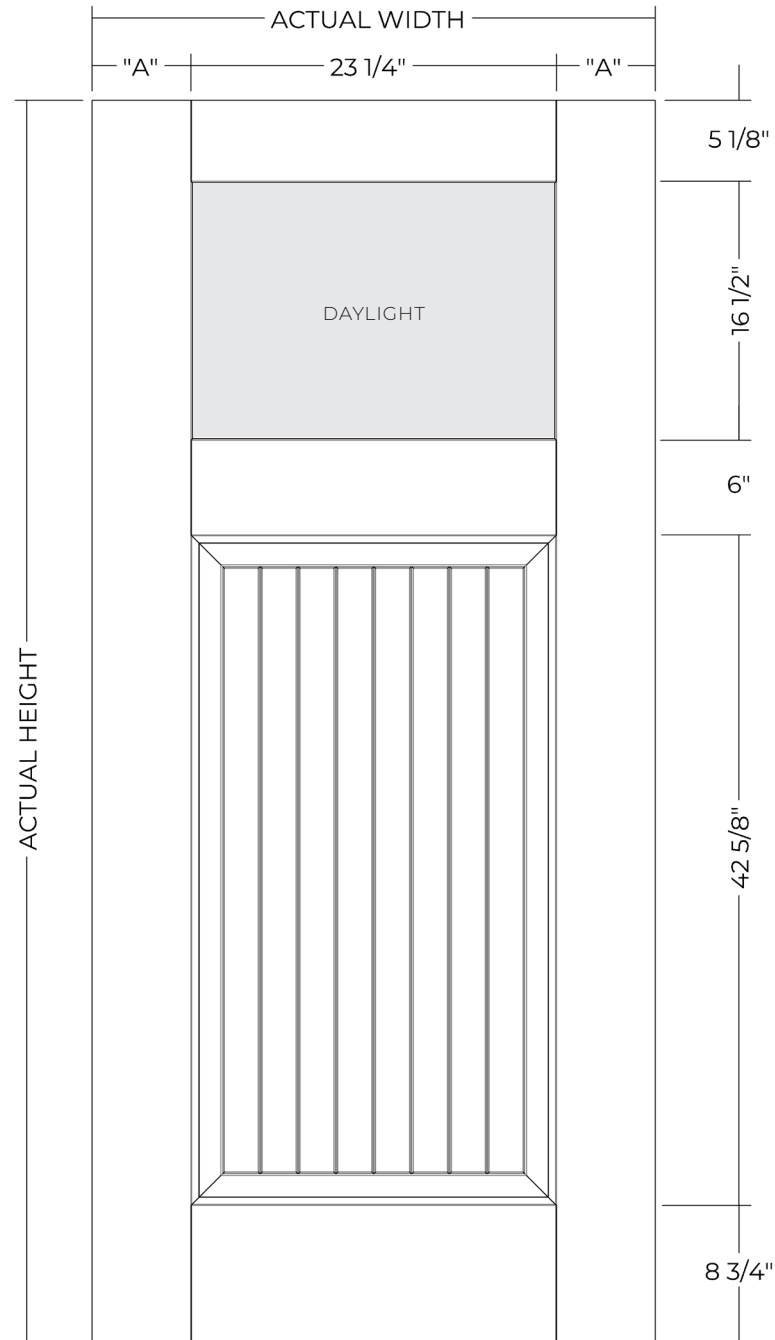

| DOOR WIDTH |         |        |
|------------|---------|--------|
| NOMINAL    | ACTUAL  | "A"    |
| 2-8        | 31 3/4" | 4 1/4" |
| 2-10       | 33 3/4" | 5 1/4" |
| 3-0        | 35 3/4" | 6 1/4" |

| DOOR HEIGHT |        |
|-------------|--------|
| NOMINAL     | ACTUAL |
| 6-8         | 79"    |

| GLASS SPECIFICATIONS |                  |
|----------------------|------------------|
| SIZE                 | DAYLIGHT         |
| 24 x 17 1/4"         | 22 7/8 x 16 1/8" |

Note: The dimension shown from bottom of door to bottom of embossment is 1/4" larger on 79 1/4" and 95 1/4" doors.

# 6'8" 1 LIGHT

FIBERGLASS SIDELIGHT

RIFT CUT | TAN | SATIN SMOOTH | WHITE

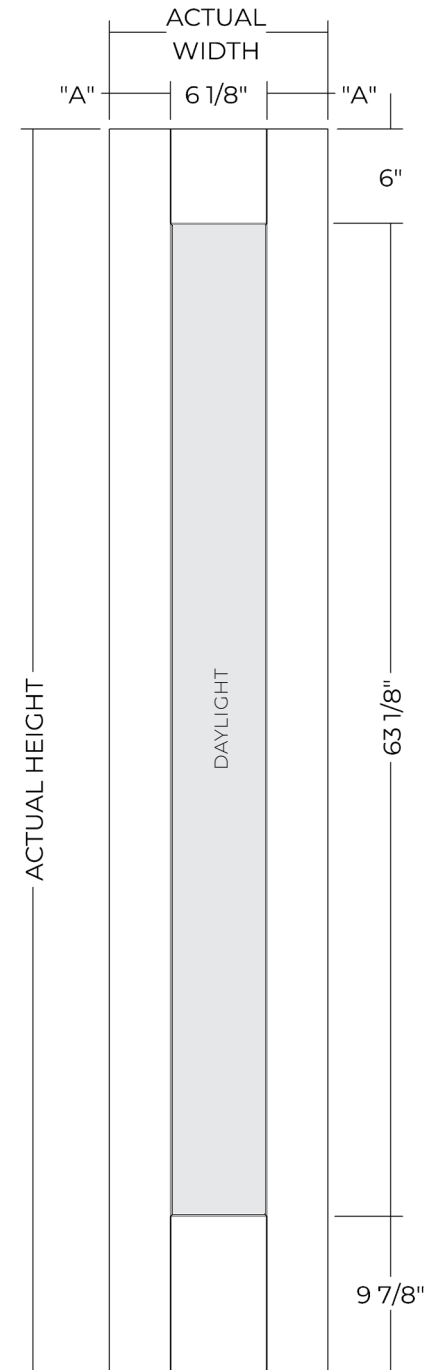

| SIDELIGHT WIDTH |         |        |
|-----------------|---------|--------|
| NOMINAL         | ACTUAL  | "A"    |
| 1-0             | 11 7/8" | 2 7/8" |
| 1-2             | 13 7/8" | 3 7/8" |

| SIDELIGHT HEIGHT |        |
|------------------|--------|
| NOMINAL          | ACTUAL |
| 6-8              | 79"    |

| GLASS SPECIFICATIONS |                 |
|----------------------|-----------------|
| SIZE                 | DAYLIGHT        |
| 7 x 64"              | 5 7/8 x 62 7/8" |

ESTATE FLUSH GLAZED

ESTATE FLUSH GLAZED

# 6'8" 3/4 LIGHT ESTATE

## FIBERGLASS SIDELIGHT

RIFT CUT | TAN | SATIN SMOOTH | WHITE

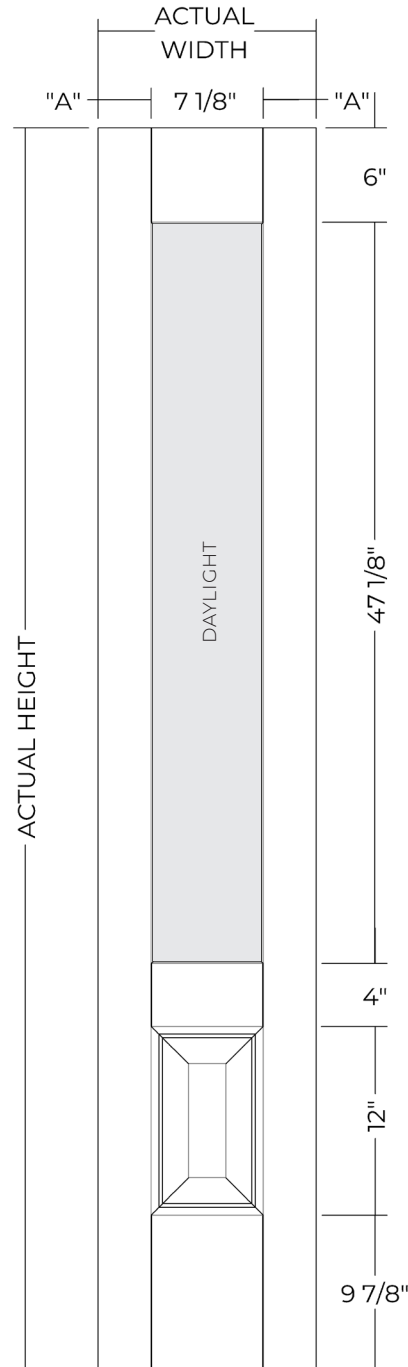

| SIDELIGHT WIDTH |         |        |
|-----------------|---------|--------|
| NOMINAL         | ACTUAL  | "A"    |
| 1-0             | 11 7/8" | 2 3/8" |
| 1-2             | 13 7/8" | 3 3/8" |

| SIDELIGHT HEIGHT |        |
|------------------|--------|
| NOMINAL          | ACTUAL |
| 6-8              | 79"    |

| GLASS SPECIFICATIONS |                |
|----------------------|----------------|
| SIZE                 | DAYLIGHT       |
| 8 x 48               | 6 7/8 x 46 7/8 |

Note: The dimension shown from bottom of door to bottom of embossment is 1/4" larger on 79 1/4" and 95 1/4" doors.

# 8'0" 1 LIGHT

## FIBERGLASS DOOR

RIFT CUT | TAN | SATIN SMOOTH | WHITE

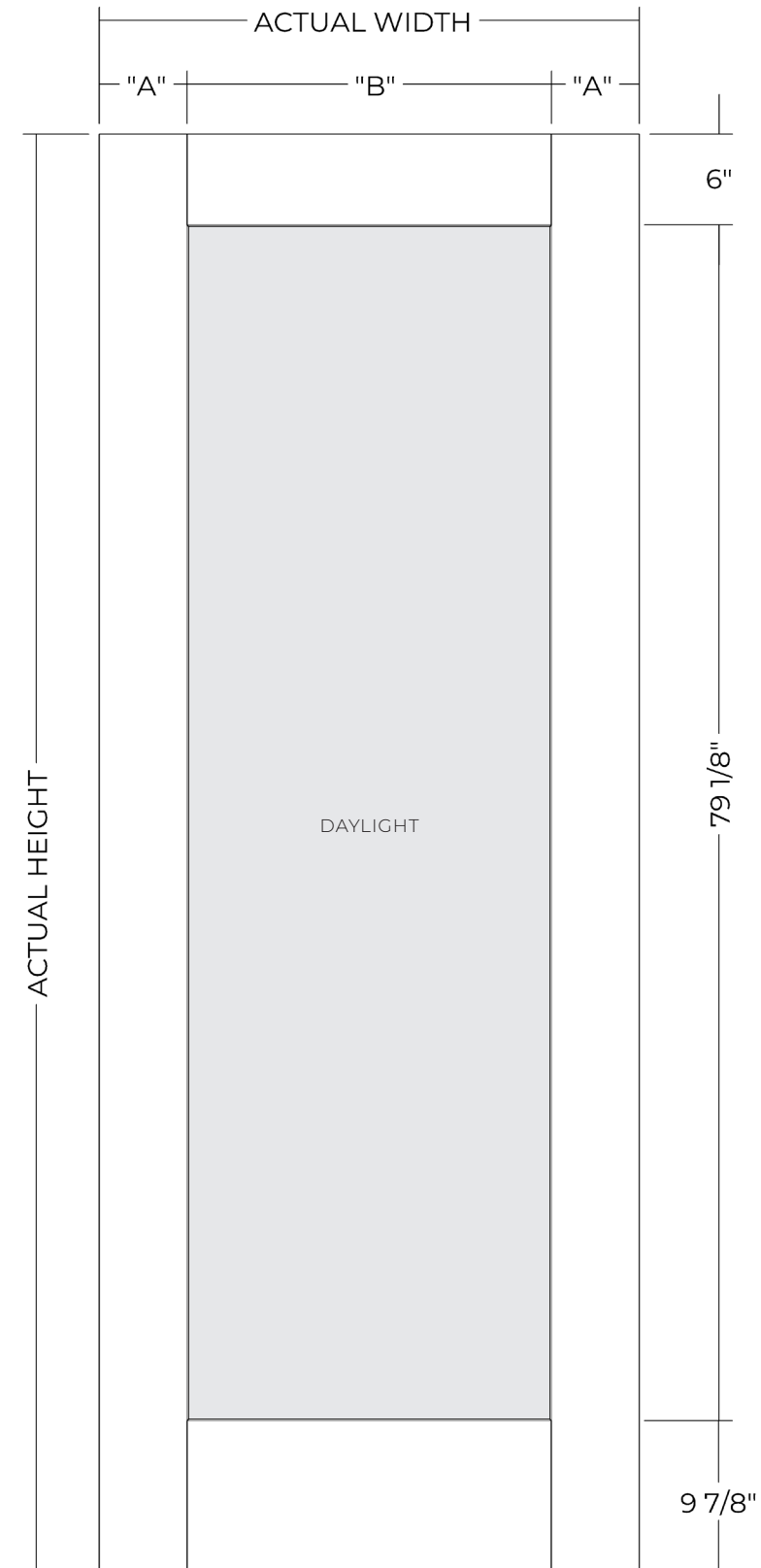

| DOOR WIDTH - 20 X 80 GLASS SIZE |         |         |         |
|---------------------------------|---------|---------|---------|
| NOMINAL                         | ACTUAL  | "A"     | "B"     |
| 2-6                             | 29 3/4" | 4 5/16" | 19 1/8" |

| DOOR HEIGHT |        |
|-------------|--------|
| NOMINAL     | ACTUAL |
| 8-0         | 95"    |

| GLASS SPECIFICATIONS |                 |
|----------------------|-----------------|
| SIZE                 | DAYLIGHT        |
| 20 x 80              | 18 7/8 x 78 7/8 |

| DOOR WIDTH - 22 X 80 GLASS SIZE |         |         |         |
|---------------------------------|---------|---------|---------|
| NOMINAL                         | ACTUAL  | "A"     | "B"     |
| 2-8                             | 31 3/4" | 5 7/16" | 21 1/8" |
| 2-10                            | 33 3/4" | 6 5/16" | 21 1/8" |
| 3-0                             | 35 3/4" | 7 5/16" | 21 1/8" |

| DOOR HEIGHT |        |
|-------------|--------|
| NOMINAL     | ACTUAL |
| 8-0         | 95"    |

| GLASS SPECIFICATIONS |                 |
|----------------------|-----------------|
| SIZE                 | DAYLIGHT        |
| 22 x 80              | 20 7/8 x 78 7/8 |

| DOOR WIDTH - 25 X 80 GLASS SIZE |         |          |         |
|---------------------------------|---------|----------|---------|
| NOMINAL                         | ACTUAL  | "A"      | "B"     |
| 2-10                            | 33 3/4" | 4 13/16" | 24 1/8" |
| 3-0                             | 35 3/4" | 5 13/16" | 24 1/8" |

| DOOR HEIGHT |        |
|-------------|--------|
| NOMINAL     | ACTUAL |
| 8-0         | 95"    |

| GLASS SPECIFICATIONS |                 |
|----------------------|-----------------|
| SIZE                 | DAYLIGHT        |
| 25 x 80              | 23 7/8 x 78 7/8 |

ESTATE FLUSH GLAZED

ESTATE FLUSH GLAZED



# 8'0" 1 LIGHT NARROW

FIBERGLASS DOOR

RIFT CUT | TAN | SATIN SMOOTH | WHITE

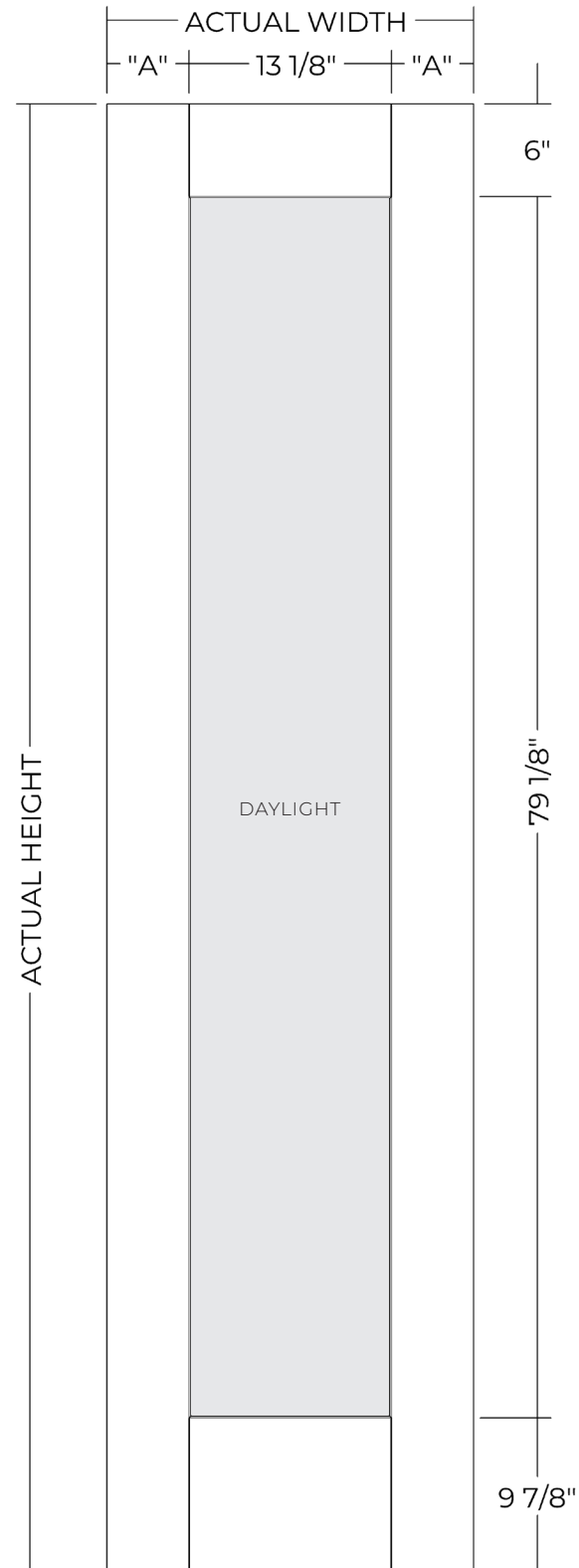

| DOOR WIDTH           |                 |         |
|----------------------|-----------------|---------|
| NOMINAL              | ACTUAL          | "A"     |
| 2-0                  | 23 3/4"         | 5 5/16" |
| DOOR HEIGHT          |                 |         |
| NOMINAL              | ACTUAL          |         |
| 8-0                  | 95"             |         |
| GLASS SPECIFICATIONS |                 |         |
| SIZE                 | DAYLIGHT        |         |
| 14 x 80              | 12 7/8 x 78 7/8 |         |

# 8'0" 3/4 LIGHT ESTATE

FIBERGLASS DOOR

SATIN SMOOTH | WHITE

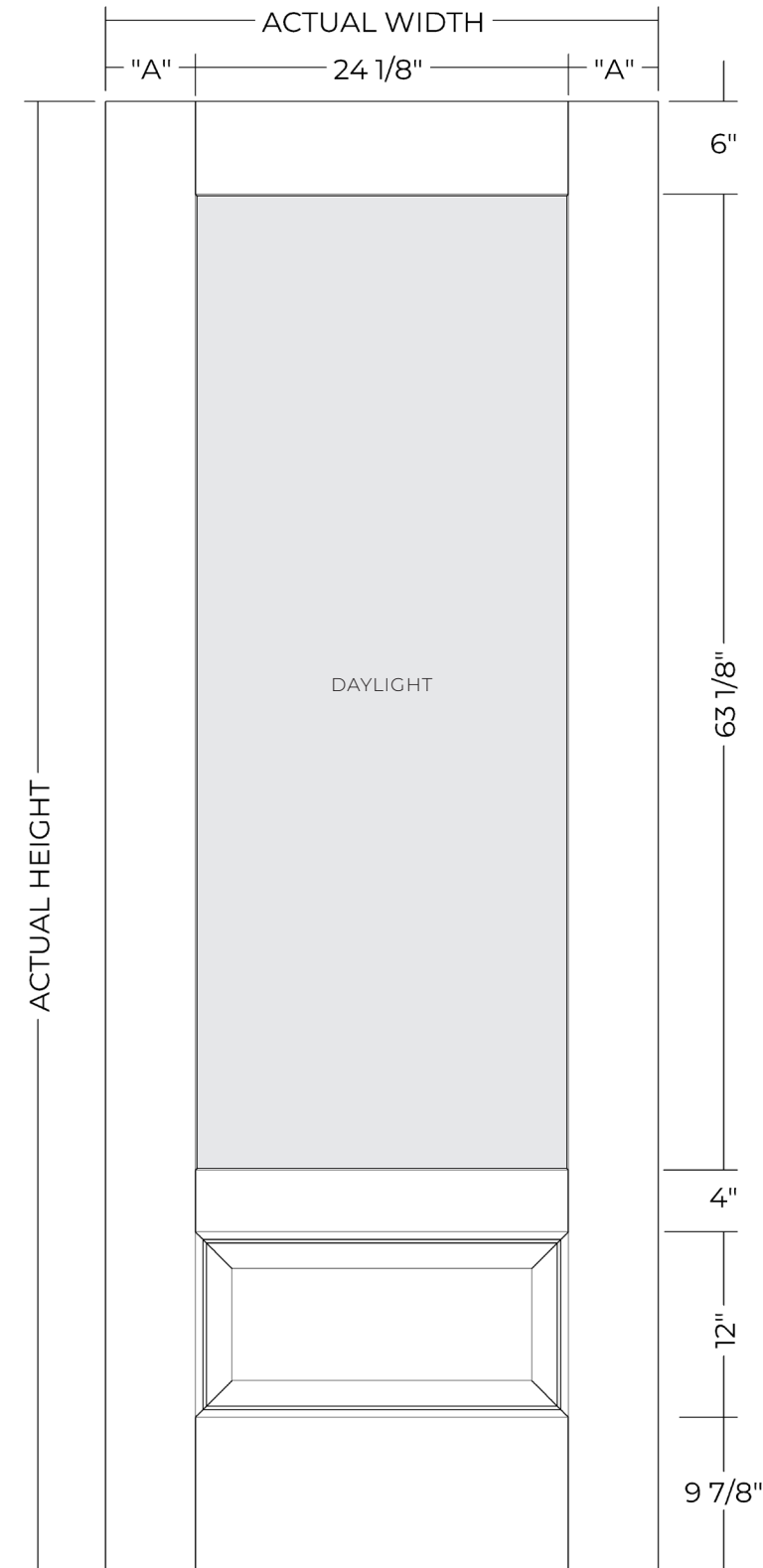

| DOOR WIDTH - 20 X 64 GLASS SIZE |                 |         |         |
|---------------------------------|-----------------|---------|---------|
| NOMINAL                         | ACTUAL          | "A"     | "B"     |
| 2-6                             | 29 3/4"         | 5 5/16" | 19 1/8" |
| 2-8                             | 31 3/4"         | 6 5/16" | 19 1/8" |
| DOOR HEIGHT                     |                 |         |         |
| NOMINAL                         | ACTUAL          |         |         |
| 8-0                             | 95"             |         |         |
| GLASS SPECIFICATIONS            |                 |         |         |
| SIZE                            | DAYLIGHT        |         |         |
| 20 x 64                         | 18 7/8 x 62 7/8 |         |         |

| DOOR WIDTH - 25 X 64 GLASS SIZE |                 |          |         |
|---------------------------------|-----------------|----------|---------|
| NOMINAL                         | ACTUAL          | "A"      | "B"     |
| 2-10                            | 33 3/4"         | 4 13/16" | 24 1/8" |
| 3-0                             | 35 3/4"         | 5 13/16" | 24 1/8" |
| DOOR HEIGHT                     |                 |          |         |
| NOMINAL                         | ACTUAL          |          |         |
| 8-0                             | 95"             |          |         |
| GLASS SPECIFICATIONS            |                 |          |         |
| SIZE                            | DAYLIGHT        |          |         |
| 25 x 64                         | 23 7/8 x 62 7/8 |          |         |

Note: The dimension shown from bottom of door to bottom of embossment is 1/4" larger on 79 1/4" and 95 1/4" doors.

ESTATE FLUSH GLAZED

ESTATE FLUSH GLAZED

# 8'0" 1 LIGHT

FIBERGLASS SIDELIGHT

RIFT CUT | TAN | SATIN SMOOTH | WHITE

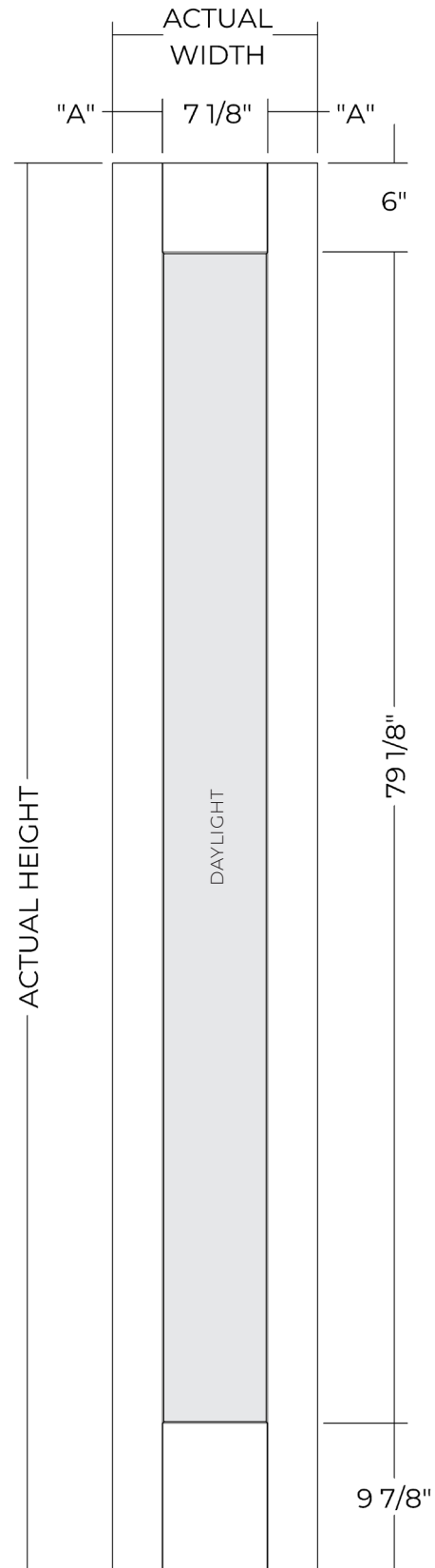

| SIDELIGHT WIDTH |         |        |
|-----------------|---------|--------|
| NOMINAL         | ACTUAL  | "A"    |
| 1-0             | 11 7/8" | 2 3/8" |
| 1-2             | 13 7/8" | 3 3/8" |

| SIDELIGHT HEIGHT |        |
|------------------|--------|
| NOMINAL          | ACTUAL |
| 8-0              | 95"    |

  

| GLASS SPECIFICATIONS |                |
|----------------------|----------------|
| SIZE                 | DAYLIGHT       |
| 8 x 80               | 6 7/8 x 78 7/8 |

# 8'0" 3/4 LIGHT ESTATE

FIBERGLASS SIDELIGHT

SATIN SMOOTH | WHITE

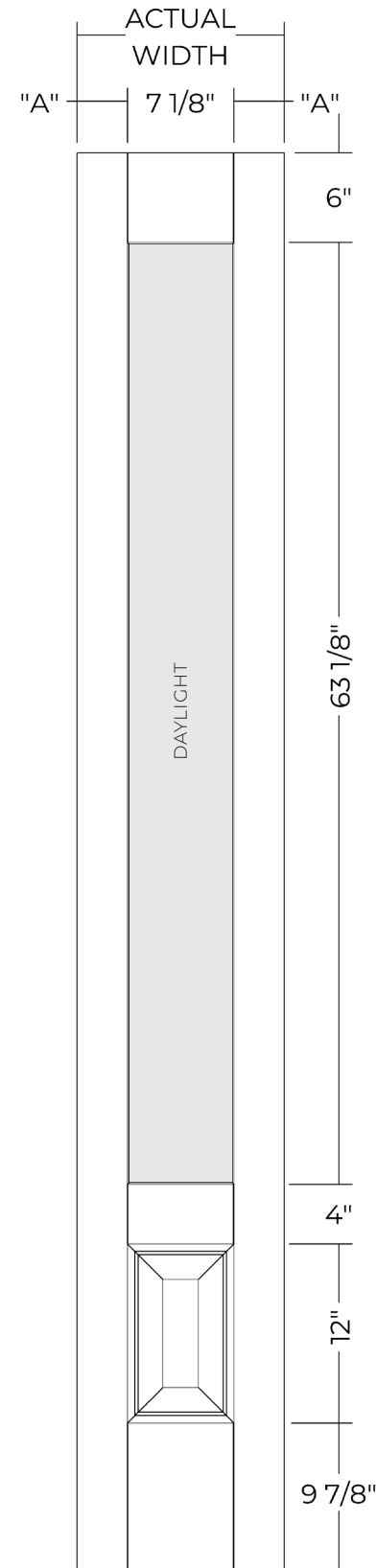

| SIDELIGHT WIDTH |         |        |
|-----------------|---------|--------|
| NOMINAL         | ACTUAL  | "A"    |
| 1-0             | 11 7/8" | 2 3/8" |
| 1-2             | 13 7/8" | 3 3/8" |

| SIDELIGHT HEIGHT |        |
|------------------|--------|
| NOMINAL          | ACTUAL |
| 8-0              | 95"    |

| GLASS SPECIFICATIONS |                |
|----------------------|----------------|
| SIZE                 | DAYLIGHT       |
| 8 x 64               | 6 7/8 x 62 7/8 |

Note: The dimension shown from bottom of door to bottom of embossment is 1/4" larger on 79 1/4" and 95 1/4" doors.

ESTATE FLUSH GLAZED

ESTATE FLUSH GLAZED

# SHAKER FLUSH GLAZED

FIBERGLASS DOORS AND SIDELIGHTS



# 6'8" 3/4 LIGHT SHAKER

FIBERGLASS DOOR

SATIN SMOOTH | WHITE

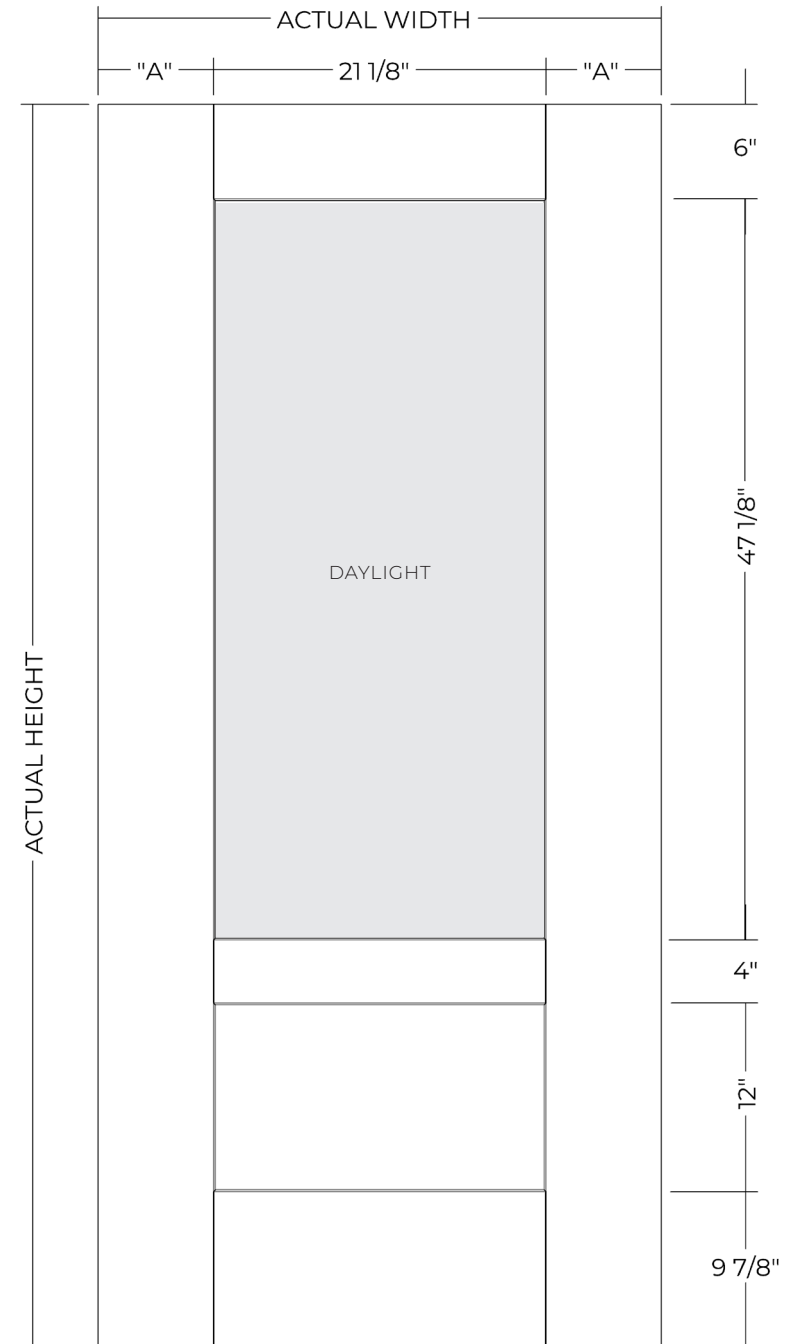

| DOOR WIDTH - 20 X 48 GLASS SIZE |         |         |
|---------------------------------|---------|---------|
| NOMINAL                         | ACTUAL  | "A"     |
| 2-8                             | 31 3/4" | 5 5/16" |
| 2-10                            | 33 3/4" | 6 5/16" |
| 3-0                             | 35 3/4" | 7 5/16" |

| DOOR HEIGHT |        |
|-------------|--------|
| NOMINAL     | ACTUAL |
| 6-8         | 79"    |

| GLASS SPECIFICATIONS |                 |
|----------------------|-----------------|
| SIZE                 | DAYLIGHT        |
| 22 x 48              | 20 7/8 x 46 7/8 |

| DOOR WIDTH - 25 X 48 GLASS SIZE |         |         |
|---------------------------------|---------|---------|
| NOMINAL                         | ACTUAL  | "A"     |
| 2-10                            | 33 3/4" | 6 5/16" |
| 3-0                             | 35 3/4" | 7 5/16" |

| DOOR HEIGHT |        |
|-------------|--------|
| NOMINAL     | ACTUAL |
| 6-8         | 79"    |

| GLASS SPECIFICATIONS |                 |
|----------------------|-----------------|
| SIZE                 | DAYLIGHT        |
| 25 x 48              | 23 7/8 x 46 7/8 |

SHAKER FLUSH GLAZED

# 6'8" 1/2 LIGHT SHAKER

FIBERGLASS DOOR

SATIN SMOOTH | WHITE

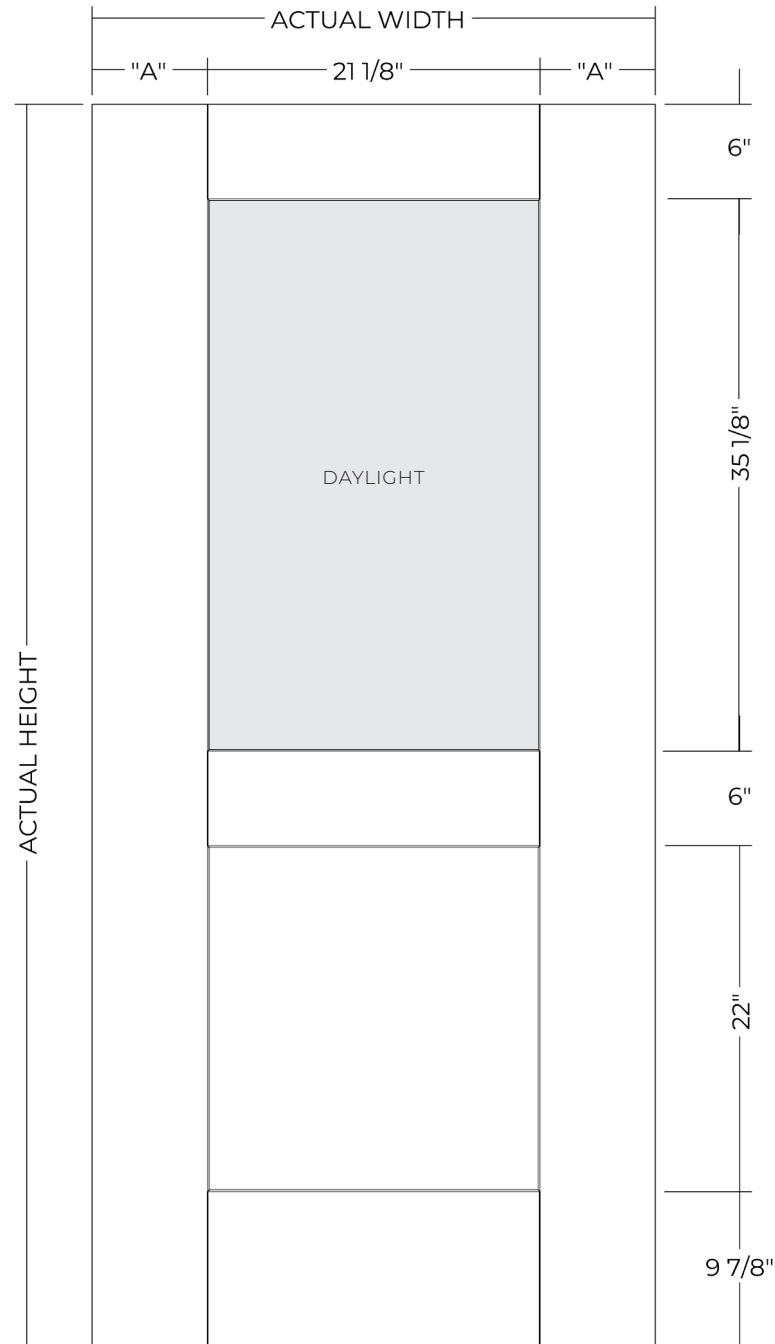

| DOOR WIDTH |         |         |
|------------|---------|---------|
| NOMINAL    | ACTUAL  | "A"     |
| 2-8        | 31 3/4" | 5 5/16" |
| 2-10       | 33 3/4" | 6 5/16" |
| 3-0        | 35 3/4" | 7 5/16" |

| DOOR HEIGHT |        |
|-------------|--------|
| NOMINAL     | ACTUAL |
| 6-8         | 79"    |

| GLASS SPECIFICATIONS |                 |
|----------------------|-----------------|
| SIZE                 | DAYLIGHT        |
| 22 x 36              | 20 7/8 x 34 7/8 |

# 6'8" 2 PANEL CRAFTSMAN

FIBERGLASS DOOR

RIFT CUT | TAN | SATIN SMOOTH | WHITE

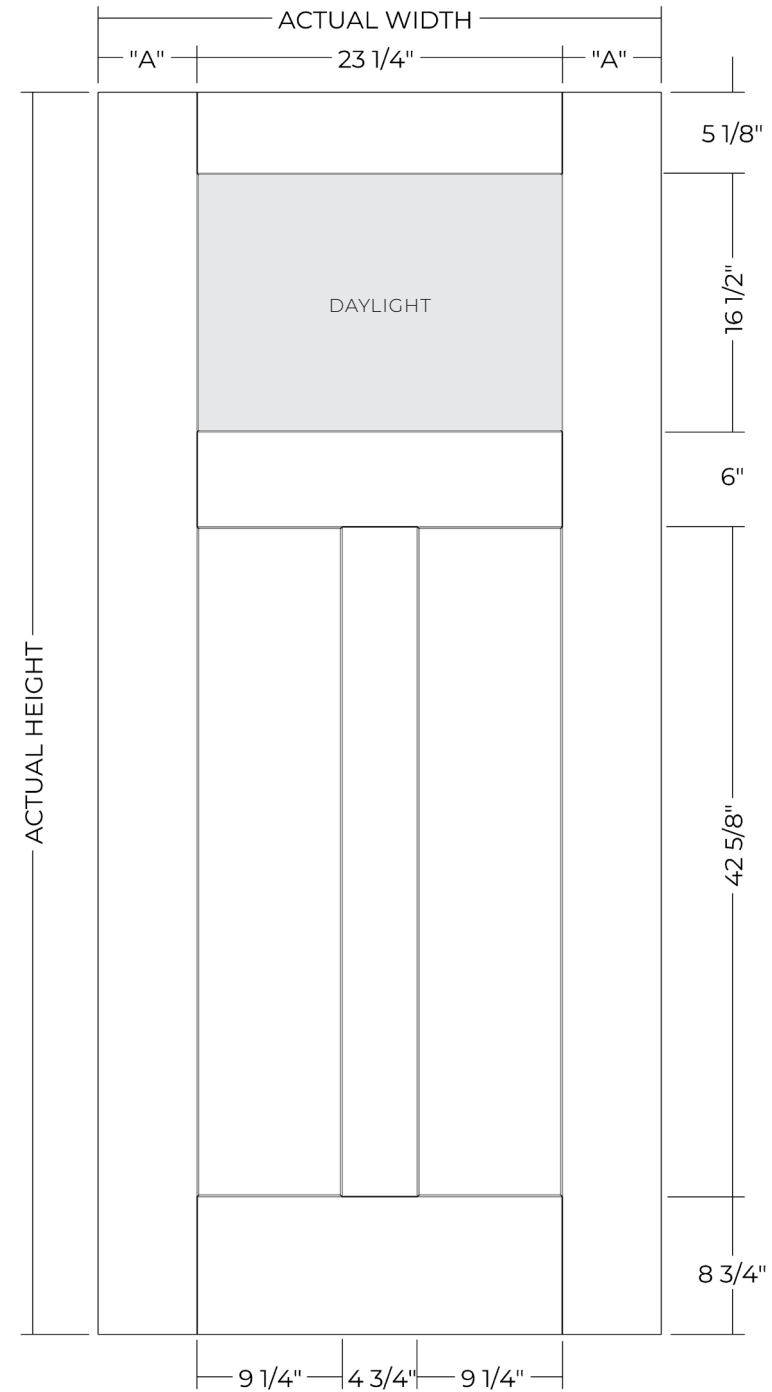

| DOOR WIDTH |         |        |
|------------|---------|--------|
| NOMINAL    | ACTUAL  | "A"    |
| 2-8        | 31 3/4" | 4 1/4" |
| 2-10       | 33 3/4" | 5 1/4" |
| 3-0        | 35 3/4" | 6 1/4" |

| DOOR HEIGHT |        |
|-------------|--------|
| NOMINAL     | ACTUAL |
| 6-8         | 79"    |

| GLASS SPECIFICATIONS |             |
|----------------------|-------------|
| SIZE                 | DAYLIGHT    |
| 24 x 17 1/4          | 23 x 16 1/4 |

SHAKER FLUSH GLAZED

SHAKER FLUSH GLAZED

# 6'8" 3/4 LIGHT SHAKER

FIBERGLASS SIDELIGHT

SATIN SMOOTH | WHITE

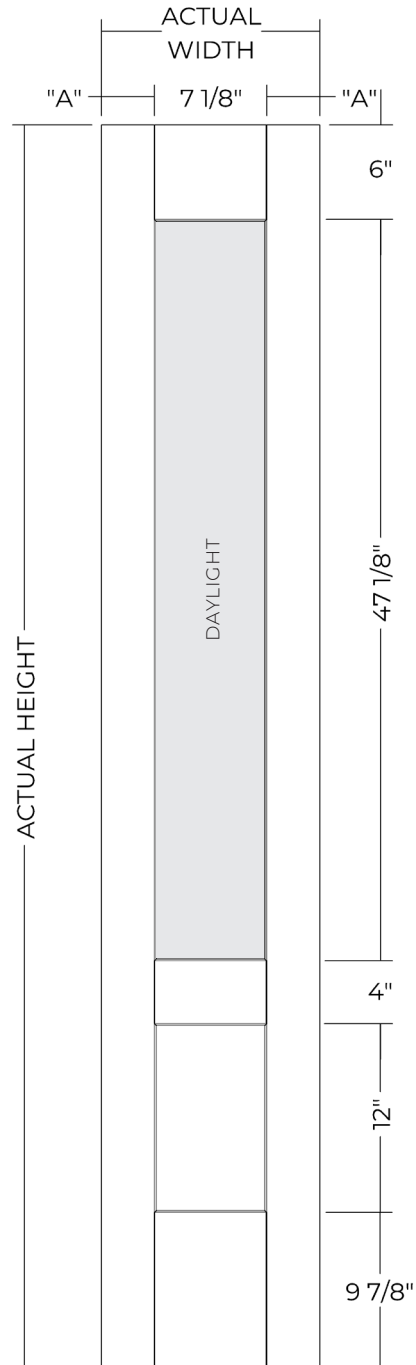

| SIDELIGHT WIDTH |         |        |
|-----------------|---------|--------|
| NOMINAL         | ACTUAL  | "A"    |
| 1-0             | 11 7/8" | 2 3/8" |
| 1-2             | 13 3/4" | 3 3/8" |

| SIDELIGHT HEIGHT |        |
|------------------|--------|
| NOMINAL          | ACTUAL |
| 6-8              | 79"    |

| GLASS SPECIFICATIONS |                |
|----------------------|----------------|
| SIZE                 | DAYLIGHT       |
| 7 x 48               | 6 7/8 x 46 7/8 |

# 6'8" CRAFTSMAN

FIBERGLASS SIDELIGHT

RIFT CUT | TAN | SATIN SMOOTH | WHITE

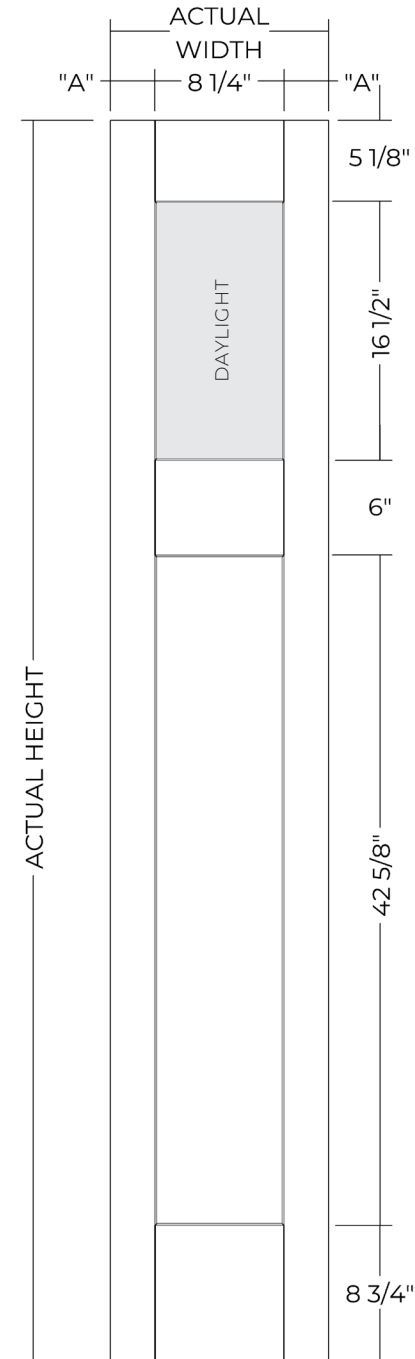

| SIDELIGHT WIDTH |         |          |
|-----------------|---------|----------|
| NOMINAL         | ACTUAL  | "A"      |
| 1-0             | 11 7/8" | 1 13/16" |
| 1-2             | 13 7/8" | 2 13/16" |

| SIDELIGHT HEIGHT |        |
|------------------|--------|
| NOMINAL          | ACTUAL |
| 6-8              | 79"    |

| GLASS SPECIFICATIONS |            |
|----------------------|------------|
| SIZE                 | DAYLIGHT   |
| 9 x 17 1/4           | 8 x 16 1/4 |

SHAKER FLUSH GLAZED

SHAKER FLUSH GLAZED

# 8'0" 3/4 LIGHT SHAKER

FIBERGLASS DOOR

SATIN SMOOTH | WHITE

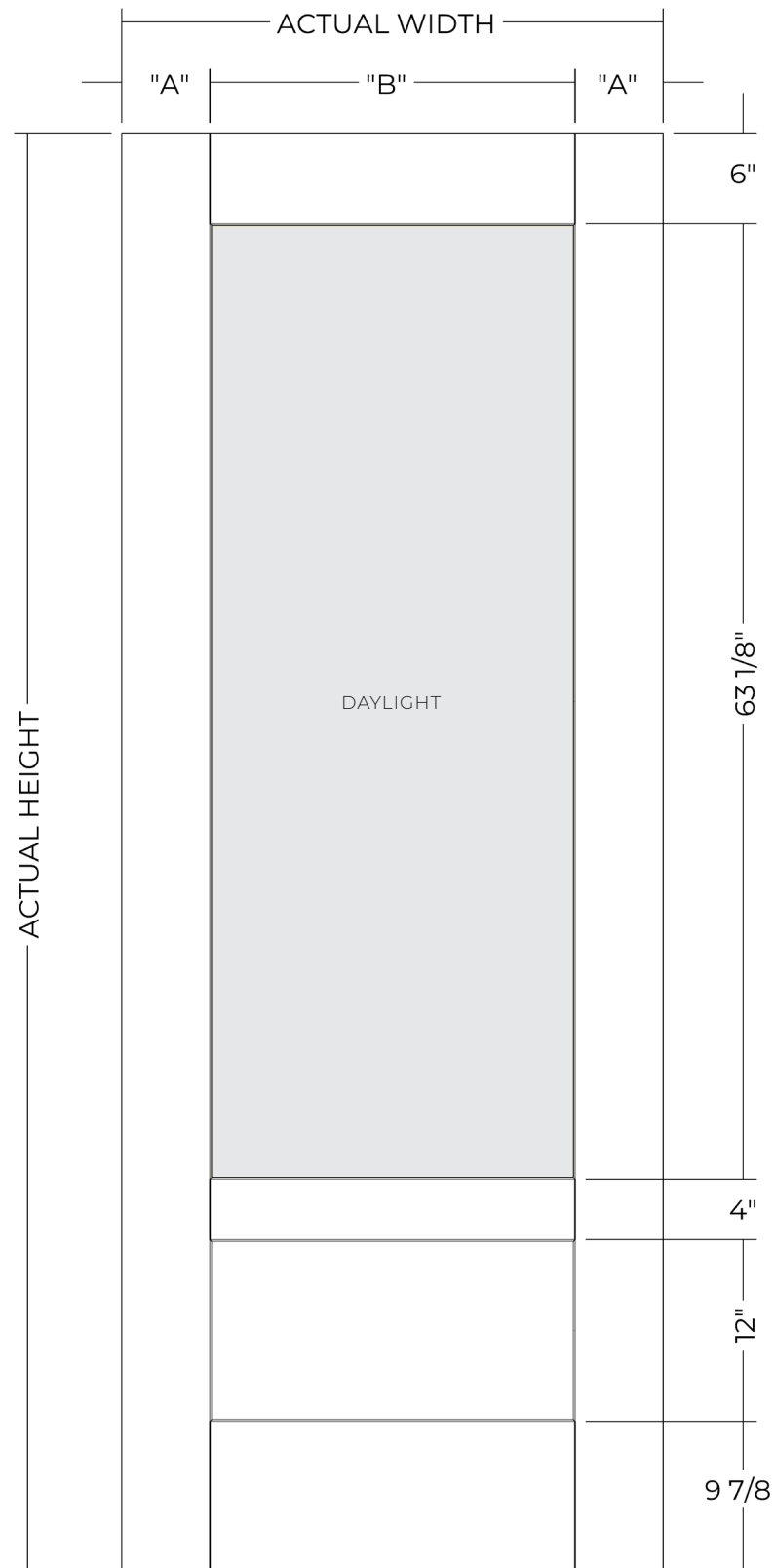

### DOOR WIDTH - 22 X 64 GLASS SIZE

| NOMINAL | ACTUAL  | "A"     | "B"     |
|---------|---------|---------|---------|
| 2-8     | 31 3/4" | 5 5/16" | 19 1/8" |
| 2-10    | 33 3/4" | 6 5/16" | 19 1/8" |
| 3-0     | 35 3/4" | 7 5/16" | 19 1/8" |

### DOOR HEIGHT

| NOMINAL | ACTUAL |
|---------|--------|
| 8-0     | 95"    |

### GLASS SPECIFICATIONS

| SIZE    | DAYLIGHT        |
|---------|-----------------|
| 22 x 64 | 18 7/8 x 62 7/8 |

### DOOR WIDTH - 25 X 64 GLASS SIZE

| NOMINAL | ACTUAL  | "A"      | "B"     |
|---------|---------|----------|---------|
| 2-10    | 33 3/4" | 4 13/16" | 24 1/8" |
| 3-0     | 35 3/4" | 5 13/16" | 24 1/8" |

### DOOR HEIGHT

| NOMINAL | ACTUAL |
|---------|--------|
| 8-0     | 95"    |

### GLASS SPECIFICATIONS

| SIZE    | DAYLIGHT        |
|---------|-----------------|
| 25 x 64 | 23 7/8 x 62 7/8 |

# 8'0" 2 PANEL CRAFTSMAN

FIBERGLASS DOOR

RIFT CUT | TAN | SATIN SMOOTH | WHITE

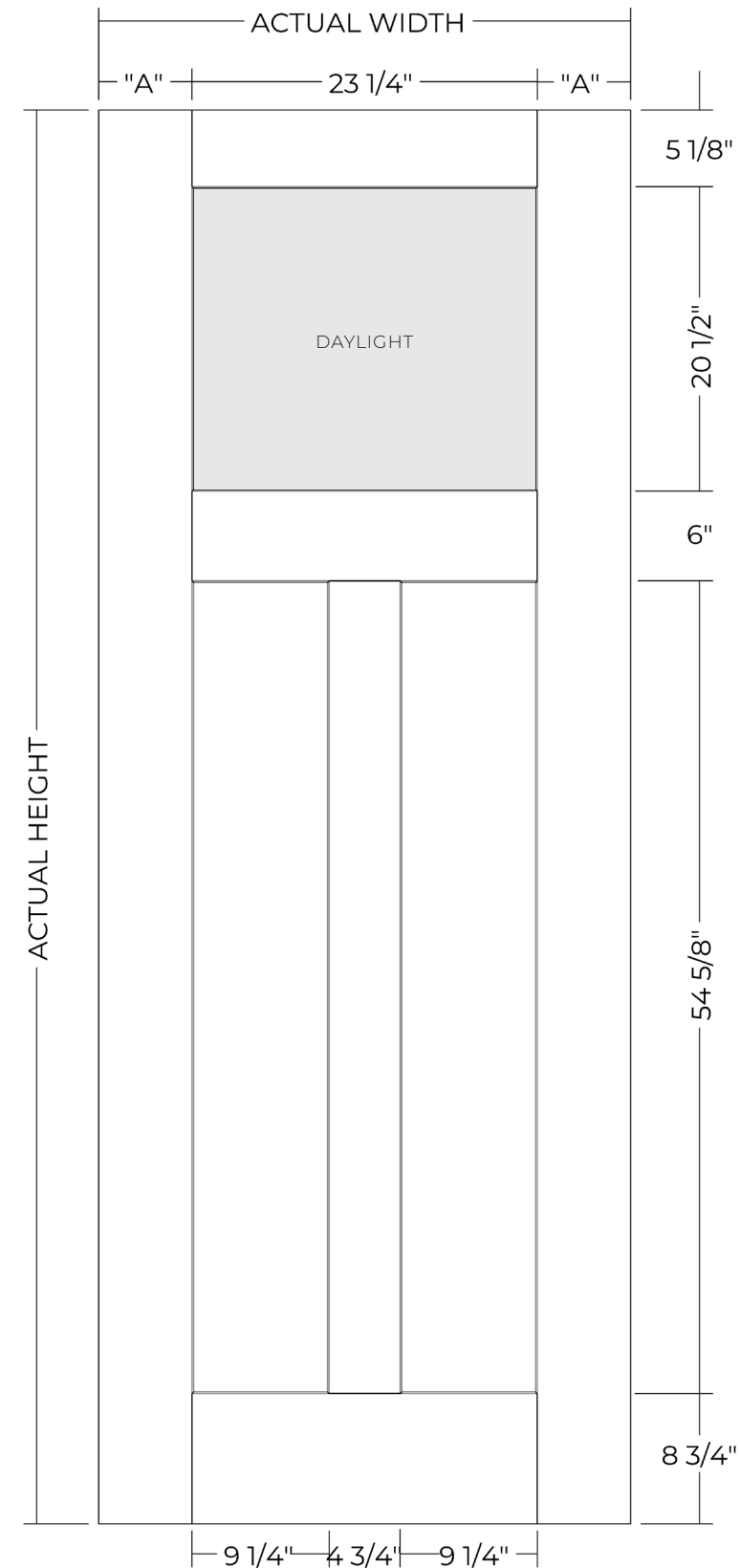

### DOOR WIDTH

| NOMINAL | ACTUAL  | "A"    |
|---------|---------|--------|
| 2-8     | 31 3/4" | 4 1/4" |
| 2-10    | 33 3/4" | 5 1/4" |
| 3-0     | 35 3/4" | 6 1/4" |

### DOOR HEIGHT

| NOMINAL | ACTUAL |
|---------|--------|
| 8-0     | 95"    |

### GLASS SPECIFICATIONS

| SIZE        | DAYLIGHT        |
|-------------|-----------------|
| 24 x 21 1/4 | 22 7/8 x 20 1/8 |

SHAKER FLUSH GLAZED

SHAKER FLUSH GLAZED

# 8'0" 3/4 LIGHT SHAKER

FIBERGLASS SIDELIGHT

SATIN SMOOTH | WHITE

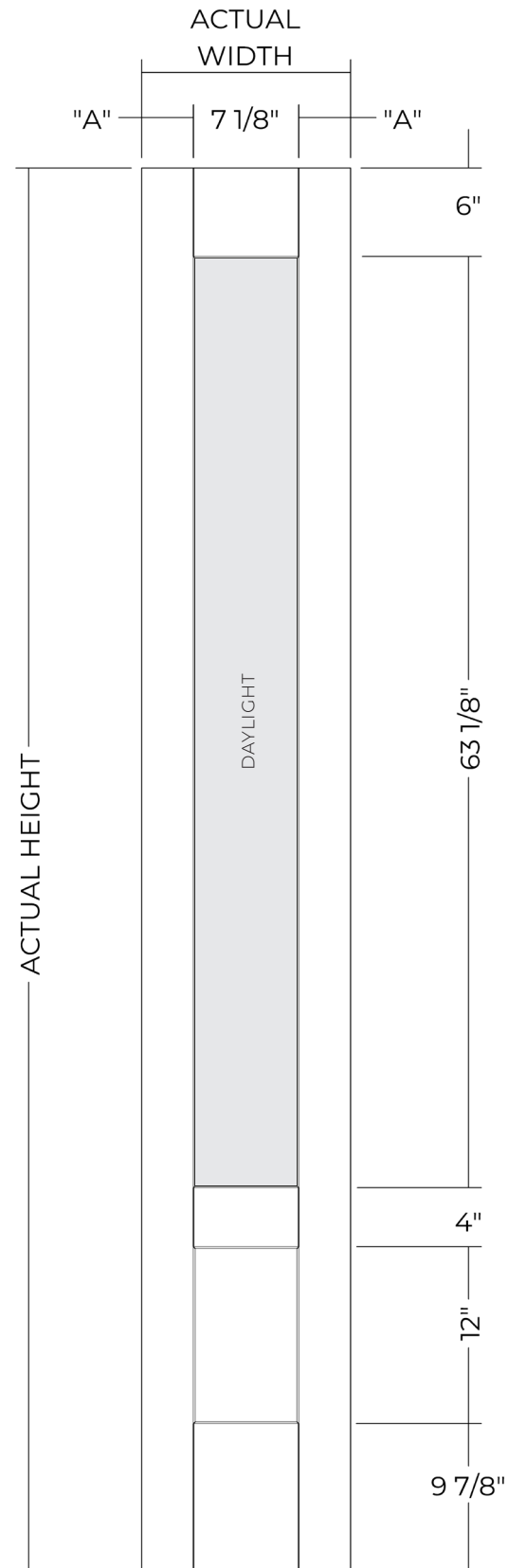

| SIDELIGHT WIDTH |         |        |
|-----------------|---------|--------|
| NOMINAL         | ACTUAL  | "A"    |
| 1-0             | 11 7/8" | 2 3/8" |
| 1-2             | 13 7/8" | 3 3/8" |

| SIDELIGHT HEIGHT |        |
|------------------|--------|
| NOMINAL          | ACTUAL |
| 8-0              | 95"    |

  

| GLASS SPECIFICATIONS |                |
|----------------------|----------------|
| SIZE                 | DAYLIGHT       |
| 8 x 64               | 6 7/8 x 62 7/8 |

# 8'0" CRAFTSMAN

FIBERGLASS SIDELIGHT

RIFT CUT | TAN | SATIN SMOOTH | WHITE

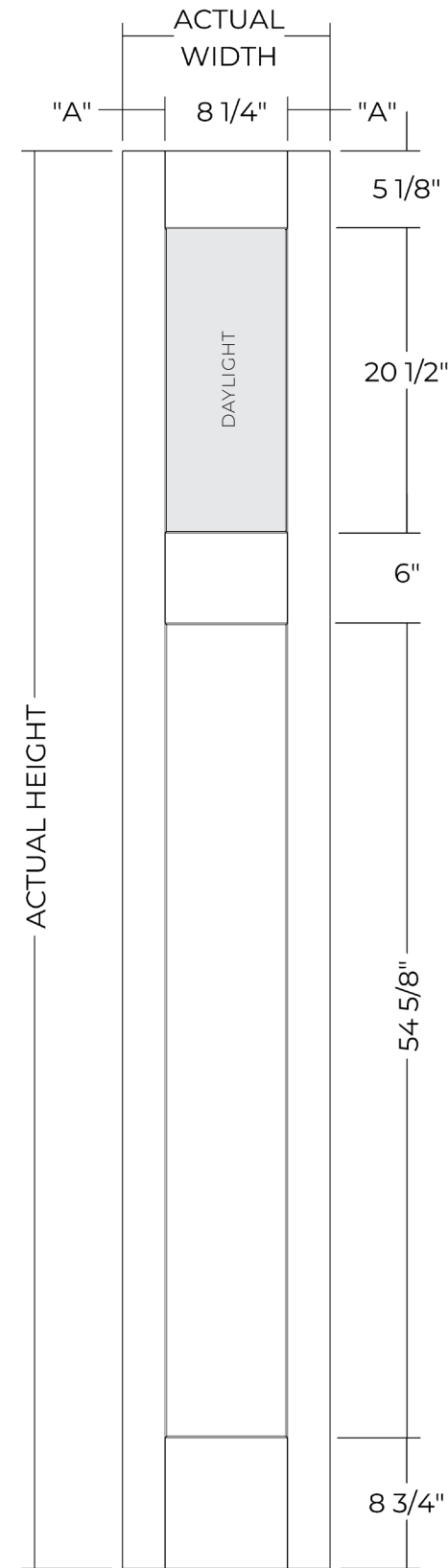

| SIDELIGHT WIDTH |         |          |
|-----------------|---------|----------|
| NOMINAL         | ACTUAL  | "A"      |
| 1-0             | 11 7/8" | 1 13/16" |
| 1-2             | 13 7/8" | 2 13/16" |

| SIDELIGHT HEIGHT |        |
|------------------|--------|
| NOMINAL          | ACTUAL |
| 8-0              | 95"    |

| GLASS SPECIFICATIONS |            |
|----------------------|------------|
| SIZE                 | DAYLIGHT   |
| 9 x 21 1/4           | 8 x 20 1/4 |

SHAKER FLUSH GLAZED

SHAKER FLUSH GLAZED

# PRO OAK

FIBERGLASS DOORS AND SIDELIGHTS



# 6'8" FLUSH

FIBERGLASS DOOR

TAN OAK | TAN | WHITE OAK | WHITE

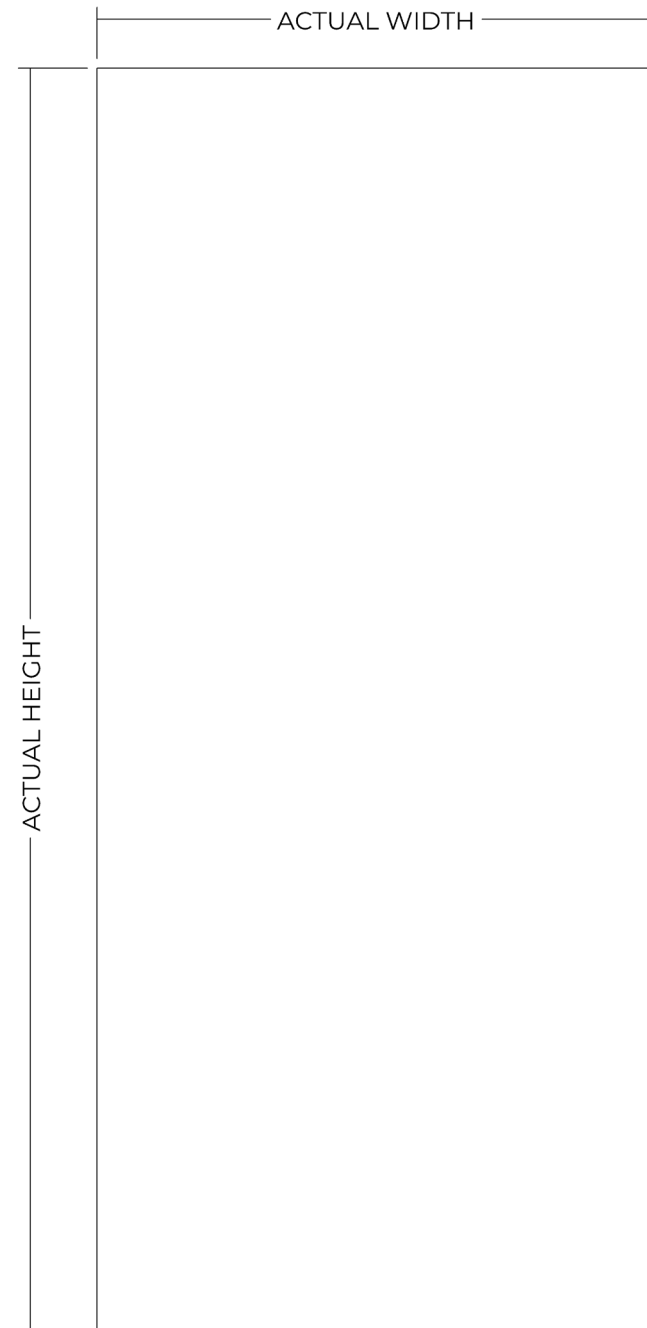

| DOOR WIDTH |         |
|------------|---------|
| NOMINAL    | ACTUAL  |
| 2-6        | 29 3/4" |
| 2-8        | 31 3/4" |
| 2-10       | 33 3/4" |
| 3-0        | 35 3/4" |
| 3-6        | 41 3/4" |

| DOOR HEIGHT |        |
|-------------|--------|
| NOMINAL     | ACTUAL |
| 6-8         | 79"    |

| GLASS OPTIONS |         |
|---------------|---------|
| SIZE          | CUTOUT  |
| 8 x 6 2L      | 9 x 7   |
| 8 x 36 2L     | 9 x 37  |
| 7 x 64        | 8 x 65  |
| 8 x 64        | 9 x 65  |
| 22 x 10       | 23 x 11 |
| 22 x 36       | 23 x 37 |
| 22 x 48       | 23 x 49 |
| 22 x 64       | 23 x 65 |
| 22 x 17 3L    | 23 x 18 |



PRO OAK



# 6'8" 6 PANEL

FIBERGLASS DOOR

TAN OAK | TAN | WHITE OAK | WHITE

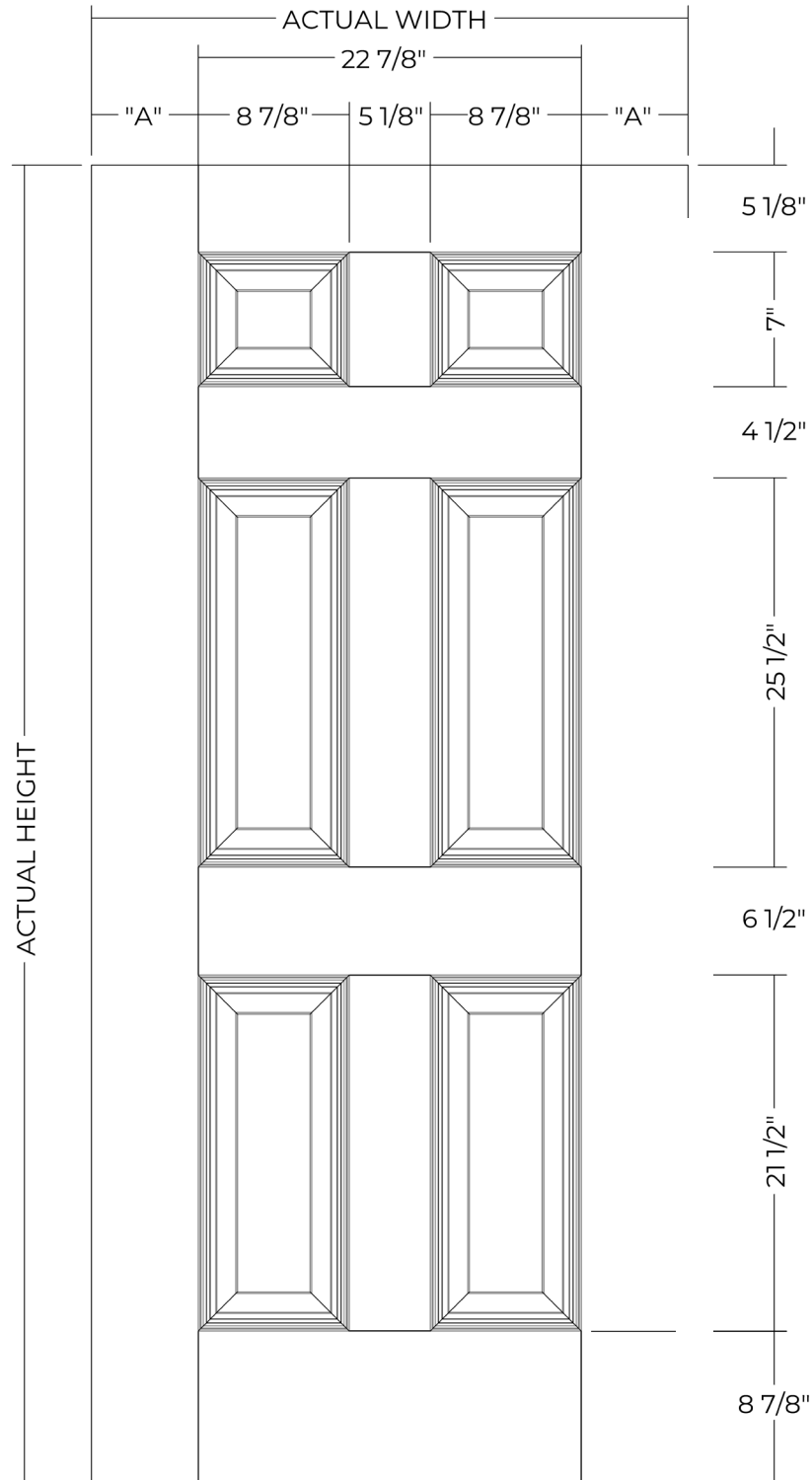

### DOOR WIDTH

| NOMINAL | ACTUAL  | "A"     |
|---------|---------|---------|
| 2-8     | 31 3/4" | 4 7/16" |
| 2-10    | 33 3/4" | 5 7/16" |
| 3-0     | 35 3/4" | 6 7/16" |

### DOOR HEIGHT

| NOMINAL | ACTUAL |
|---------|--------|
| 6-8     | 79"    |

### GLASS OPTIONS

| SIZE      | CUTOUT  |
|-----------|---------|
| 22 x 36   | 23 x 37 |
| 22 x 64   | 23 x 65 |
| 8 x 6 2L  | 9 x 7   |
| 8 x 36 2L | 9 x 37  |
| 8 x 64 2L | 9 x 65  |



Note: The dimension shown from bottom of door to bottom of embossment is 1/4" larger on 79 1/4" and 95 1/4" doors.

# 6'8" 6 PANEL NARROW

FIBERGLASS DOOR

TAN OAK | TAN | WHITE OAK | WHITE

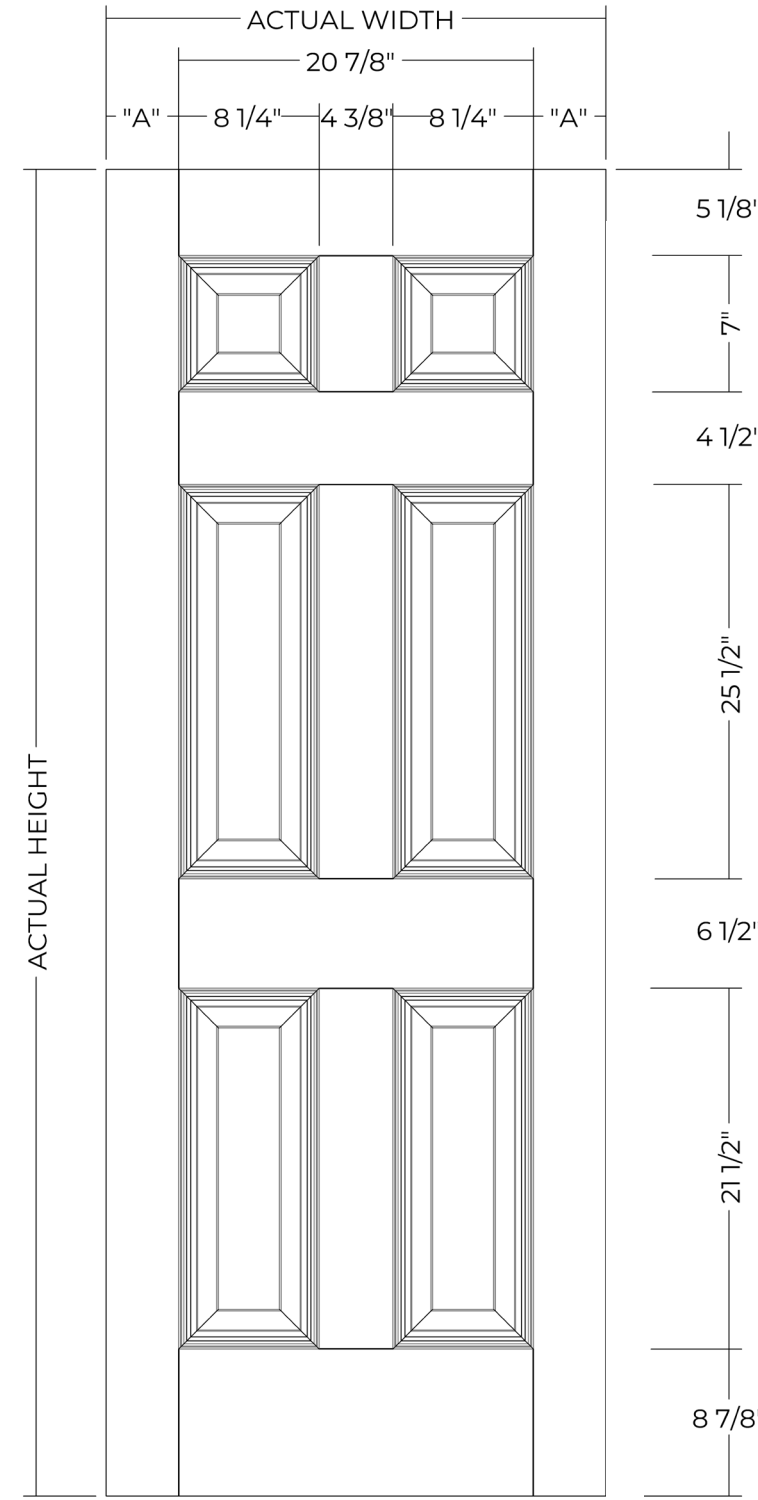

### DOOR WIDTH

| NOMINAL | ACTUAL  | "A"     |
|---------|---------|---------|
| 2-6*    | 29 3/4" | 4 7/16" |

### DOOR HEIGHT

| NOMINAL | ACTUAL |
|---------|--------|
| 6-8     | 79"    |

### GLASS OPTIONS

| SIZE    | CUTOUT  |
|---------|---------|
| 20 x 36 | 21 x 37 |
| 20 x 64 | 21 x 65 |



\* 2 3/8" Backset Only

Note: The dimension shown from bottom of door to bottom of embossment is 1/4" larger on 79 1/4" and 95 1/4" doors.

PRO OAK

PRO OAK

# 6'8" 4 PANEL BLANK TOP

FIBERGLASS DOOR

TAN OAK | TAN | WHITE OAK | WHITE

### DOOR WIDTH

| NOMINAL | ACTUAL  | "A"     |
|---------|---------|---------|
| 2-8     | 31 3/4" | 4 5/16" |
| 2-10    | 33 3/4" | 5 5/16" |
| 3-0     | 35 3/4" | 6 5/16" |

### DOOR HEIGHT

| NOMINAL | ACTUAL |
|---------|--------|
| 6-8     | 79"    |

### GLASS OPTIONS

| SIZE         | CUTOUT      |
|--------------|-------------|
| 9 x 21 SUN** | 10 x 22 SUN |
| 22 x 10      | 23 x 11     |
| 22 x 10 AT** | 23 x 11 AT  |
| 22 x 36      | 23 x 37     |
| 22 x 36 RT** | 23 x 37 RT  |
| 22 x 38 AT** | 23 x 39 AT  |
| 22 x 64      | 23 x 65     |
| 22 x 64 RT** | 23 x 65     |

\*\*Refer to page 144-145 for non-rectangular cutout dimensions

Note: The dimension shown from bottom of door to bottom of embossment is 1/4" larger on 79 1/4" and 95 1/4" doors.

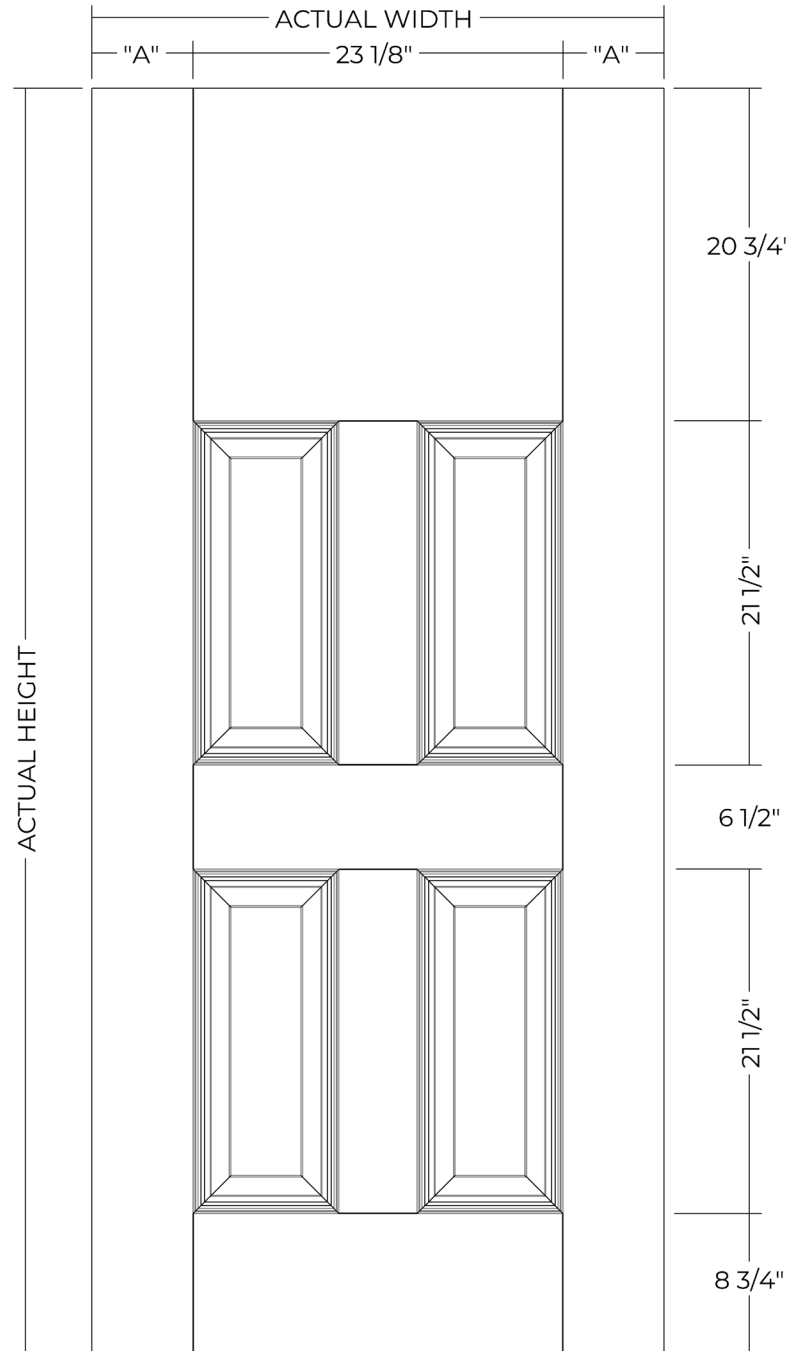

# 6'8" 2 PANEL CAMBER PLANK

FIBERGLASS DOOR

TAN OAK | TAN | WHITE OAK | WHITE

### DOOR WIDTH

| NOMINAL | ACTUAL  | "A"     |
|---------|---------|---------|
| 2-8     | 31 3/4" | 4 5/16" |
| 2-10    | 33 3/4" | 5 5/16" |
| 3-0     | 35 3/4" | 6 5/16" |

### DOOR HEIGHT

| NOMINAL | ACTUAL |
|---------|--------|
| 6-8     | 79"    |

### GLASS OPTIONS

| SIZE         | CUTOUT     |
|--------------|------------|
| 22 x 36      | 23 x 37    |
| 22 x 38 AT** | 23 x 39 AT |
| 22 x 64      | 23 x 65    |

\*\*Refer to page 144-145 for non-rectangular cutout dimensions

Note: The dimension shown from bottom of door to bottom of embossment is 1/4" larger on 79 1/4" and 95 1/4" doors.

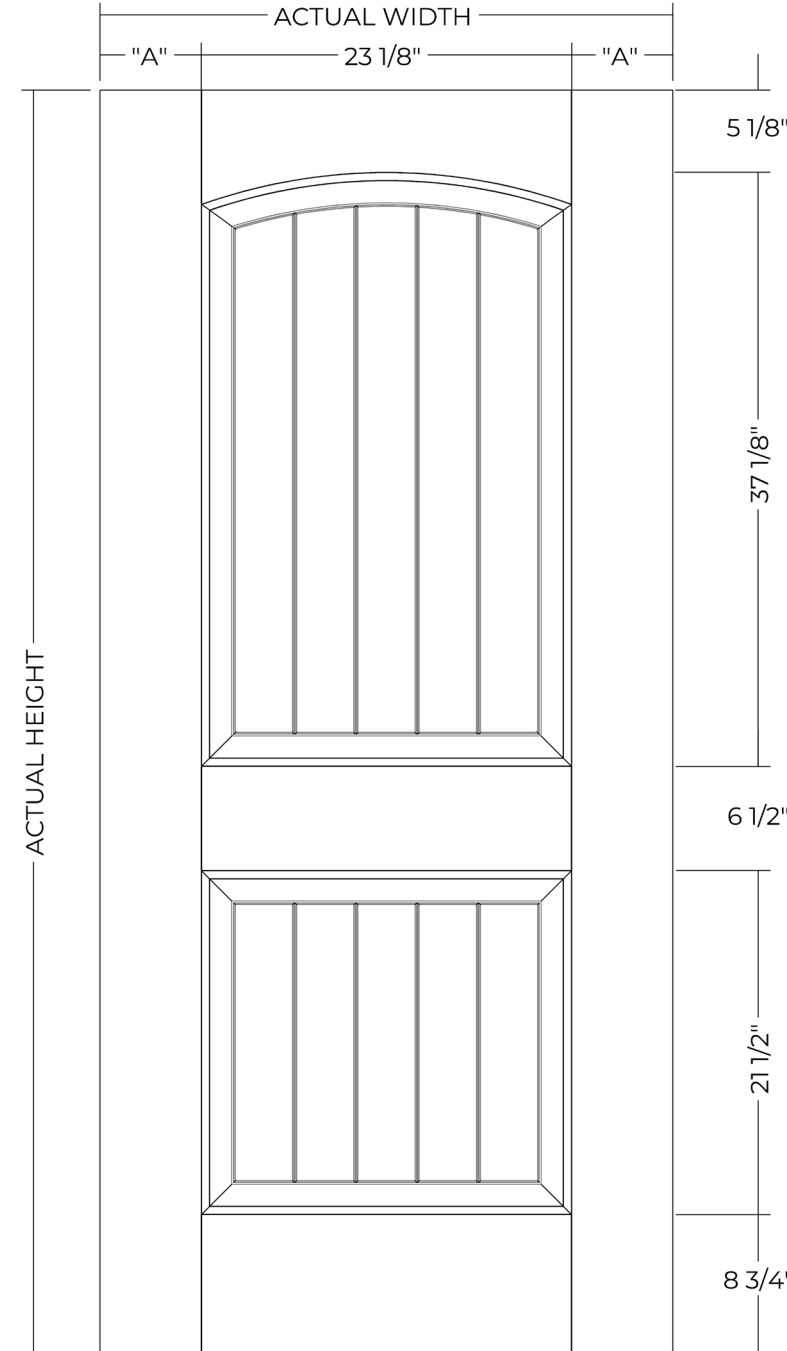

PRO OAK

PRO OAK

# 6'8" FLUSH FIBERGLASS SIDELIGHT

TAN OAK | TAN | WHITE OAK | WHITE

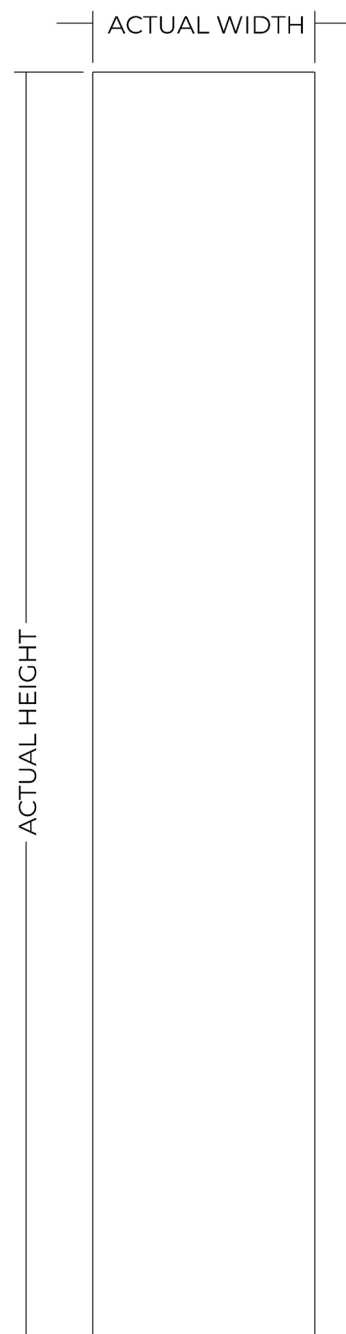

| SIDELIGHT WIDTH |         |
|-----------------|---------|
| NOMINAL         | ACTUAL  |
| 1-0             | 11 7/8" |
| 1-2             | 13 7/8" |

| SIDELIGHT HEIGHT |        |
|------------------|--------|
| NOMINAL          | ACTUAL |
| 6-8              | 79"    |

| GLASS OPTIONS |        |
|---------------|--------|
| SIZE          | CUTOUT |
| 7 x 64        | 8 x 65 |
| 8 x 64        | 9 x 65 |

# STEEL DOORS



PRO OAK

# FEATURES

## WOOD-EDGE STEEL DOORS

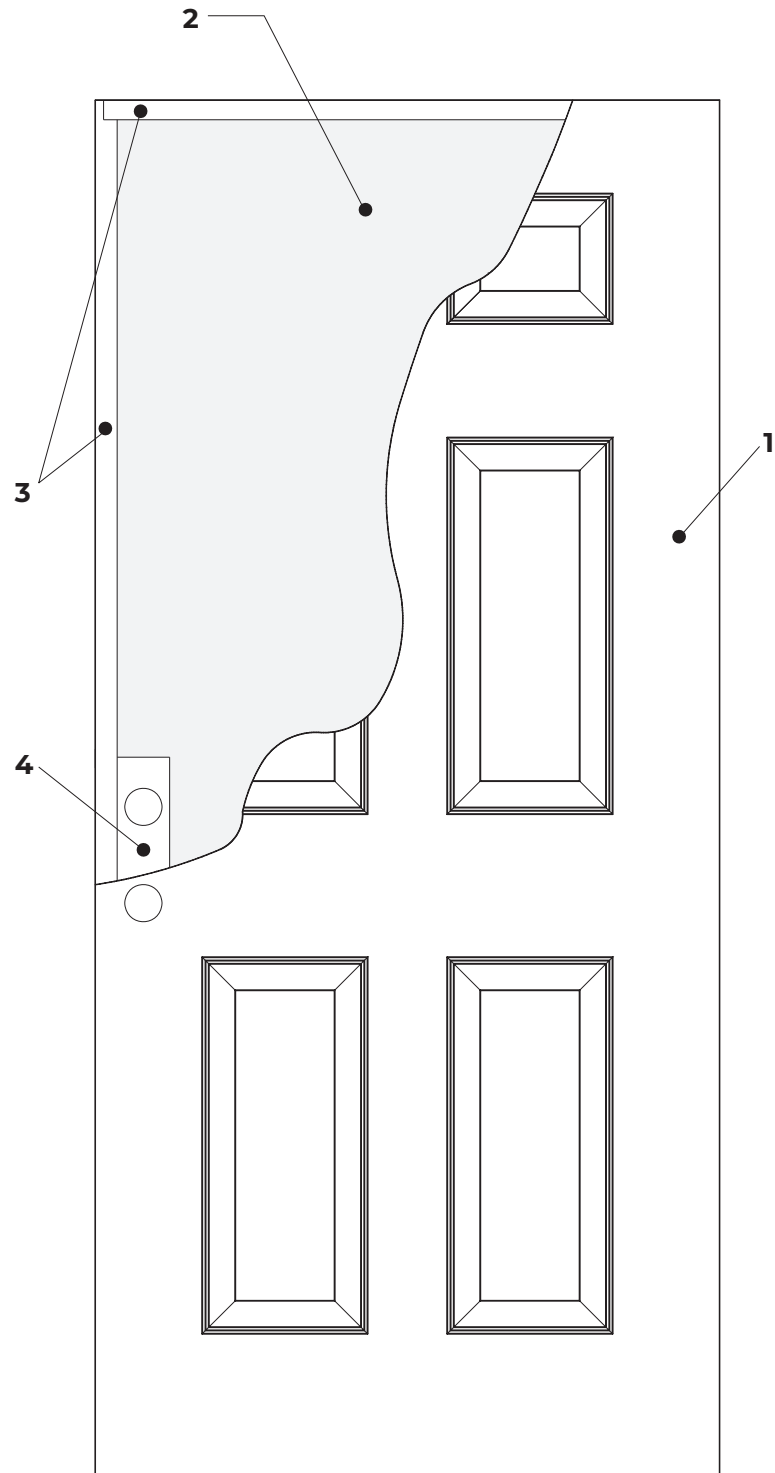

### 1.0 STEEL MARK, STEEL MARK PLUS & STEEL PRO SKINS

- 1.1 Grade:- G40 hot-dipped galvanized
- 1.2 24 gauge (Steel Mark & Steel Mark Plus)
- 1.3 25 gauge (Steel Pro)

### 2.0 FOAM CORE

- 2.1 Material: Polyurethane
- 2.2 Density: 2.2 lbs/cu.ft

### 3.0 WOOD PERIMETER

- 3.1 Material: spruce, pine, fir, or equivalent
- 3.2 Source: SFI 3<sup>rd</sup> party chain of custody certified

### 4.0 WOOD LOCK BLOCK

- 4.1 4" x 12" pine (includes stile thickness) 6'8" and 7'0"
- 4.2 4" x 24" pine (includes stile thickness) 8'0"

### PRIMER | PAINT COATING

- Material – polyester based paint

### PACKAGING

- Doors per pallet: 27
- SideLights per pallet: 30
- Banding: Metal (x2)
- Other: Corner boards (x4) Polyfilm wrap
- Product identification all four sides
- Four way access pallet

### FIRE RATING

- 20 minute positive pressure with hose stream up to 3'0" x 6'8"

### STANDARD FEATURES

- 4" mortise hinge prep
- Cylindrical lock prep
- Proud edge design
- 1 3/4" door width

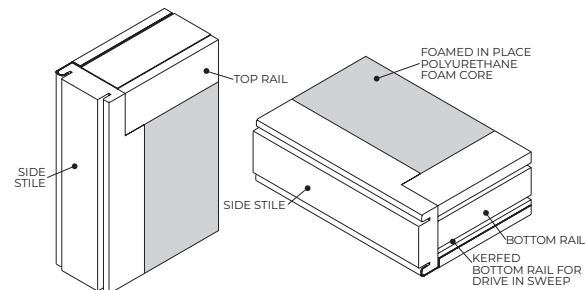

STILE & RAIL CONSTRUCTION DETAIL

# FEATURES

## STEEL-EDGE STEEL DOORS

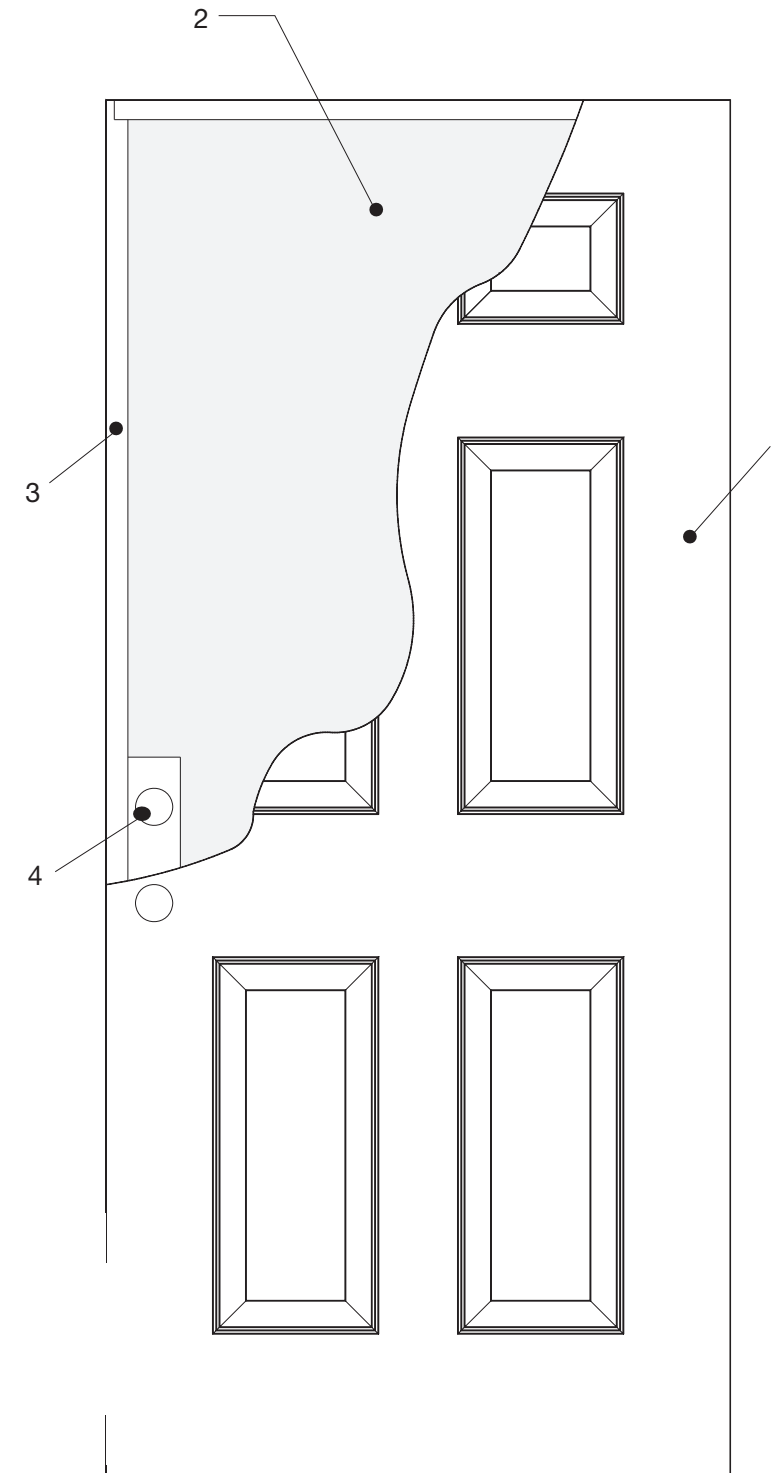

### 1.0 STEEL MARK & STEEL MARK PLUS SKINS

- 1.1 Grade:- G40 hot-dipped galvanized
- 1.2 24 gauge (Steel Mark & Steel Mark Plus)

### 2.0 FOAM CORE

- 2.1 Material: Polyurethane
- 2.2 Density: 2.2 lbs/cu.ft

### 3.0 WOOD PERIMETER WITH STEEL EDGE STILES

- 3.1 Material: spruce, pine, fir, or equivalent
- 3.2 Source: SFI 3<sup>rd</sup> party chain of custody certified
- 3.3 22 gauge steel edge plates

### 4.0 WOOD LOCK BLOCK

- 4.1 4" x 12" pine (includes stile thickness) 6'8"

### PRIMER | PAINT COATING

- Material – polyester based paint

### PACKAGING

- Doors per pallet: 27
- SideLights per pallet: 30
- Banding: Metal (x2)
- Other: Corner boards (x4) Polyfilm wrap
- Product identification all four sides
- Four way access pallet

### FIRE RATING

- 20 minute positive pressure without hose stream up to 3'0" x 6'8"

### STANDARD FEATURES

- 4" surface mounted adjustable hinge prep
- Cylindrical lock prep
- Proud edge design
- 1 3/4" door width

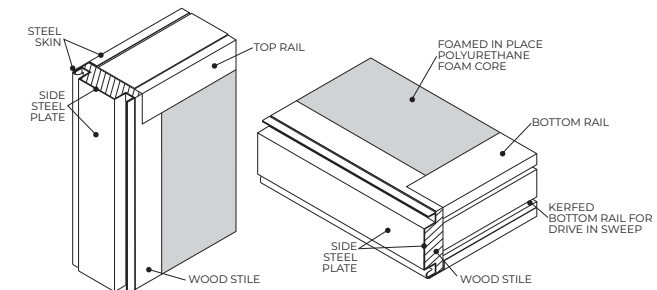

STILE & RAIL CONSTRUCTION DETAIL

# EDGE PREP DETAILS

STEEL-EDGE STEEL DOORS

## LATCH PREP

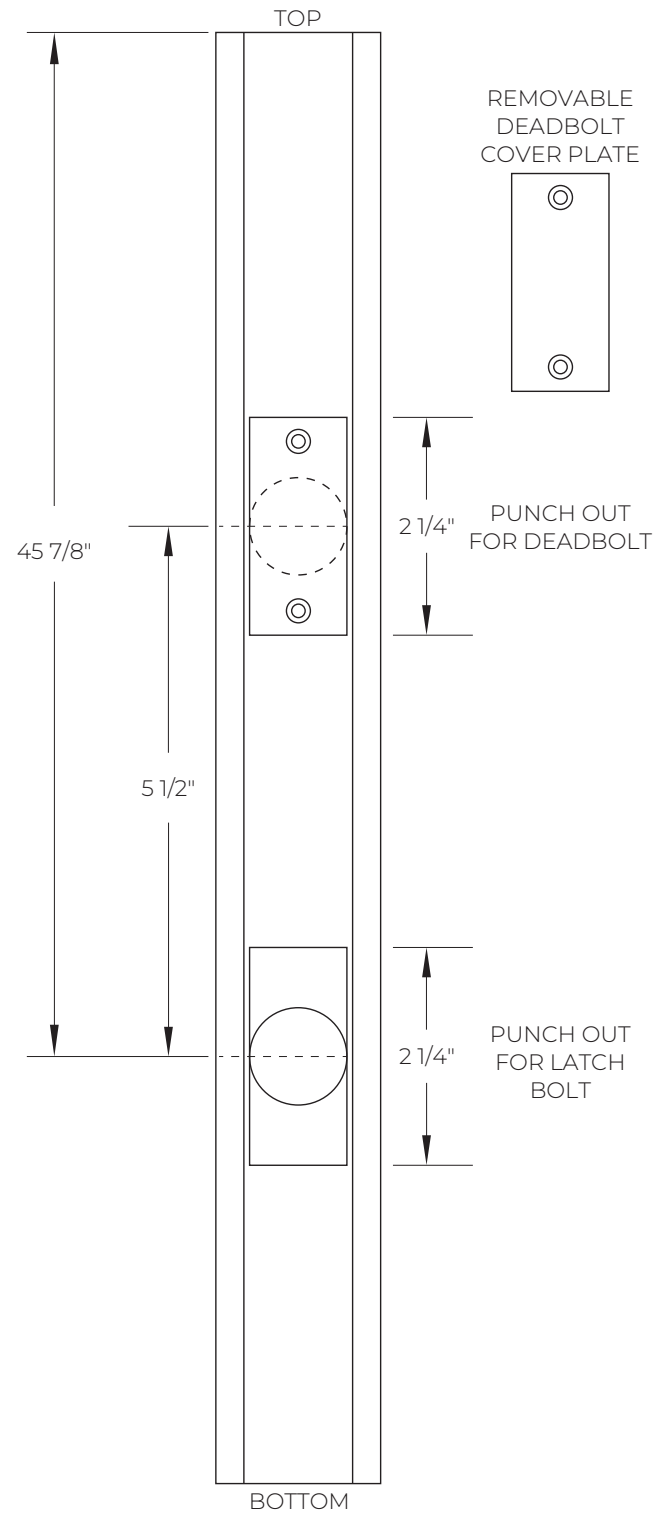

## HINGE PREP

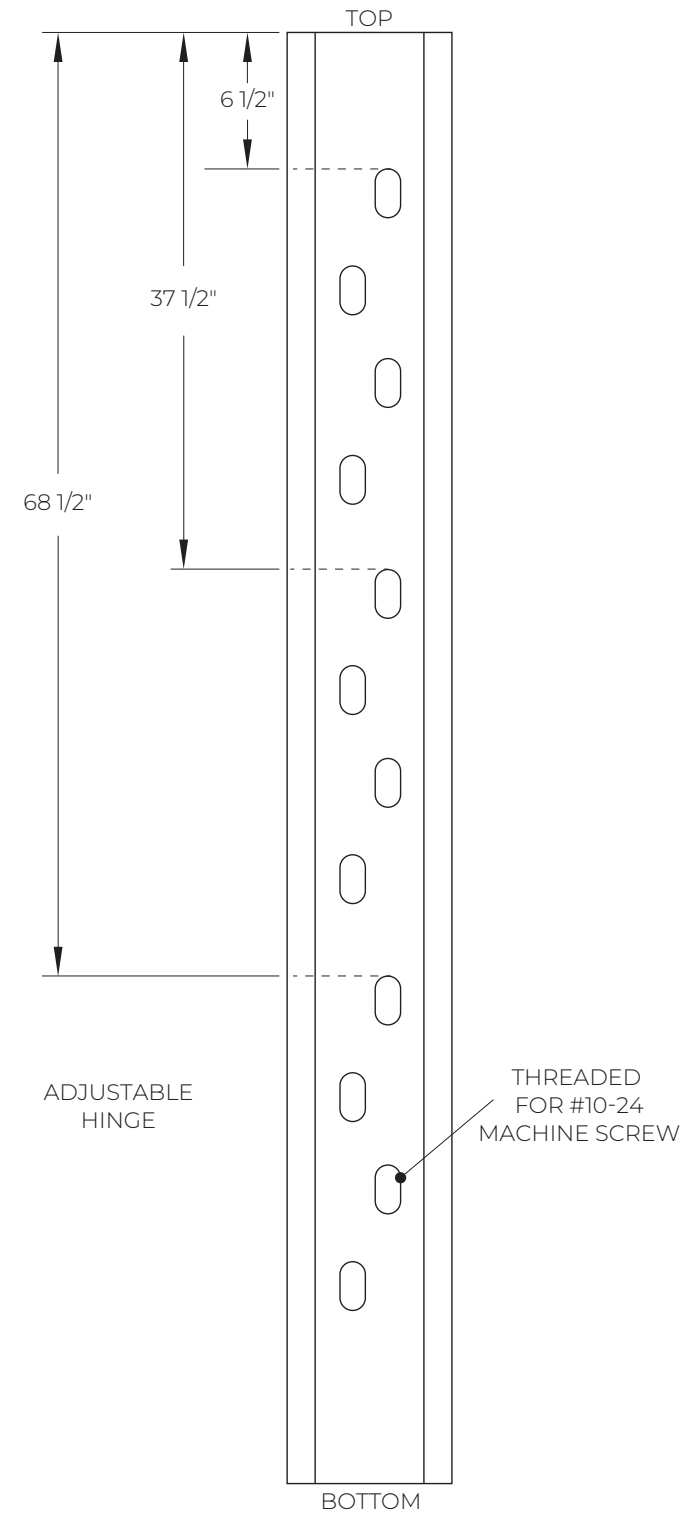

# HARDWARE LOCATIONS

FOR WOOD-EDGE AND STEEL-EDGE STEEL DOORS

## 6'8" LOCATIONS WOOD-EDGE & STEEL EDGE 7'0" LOCATIONS WOOD-EDGE

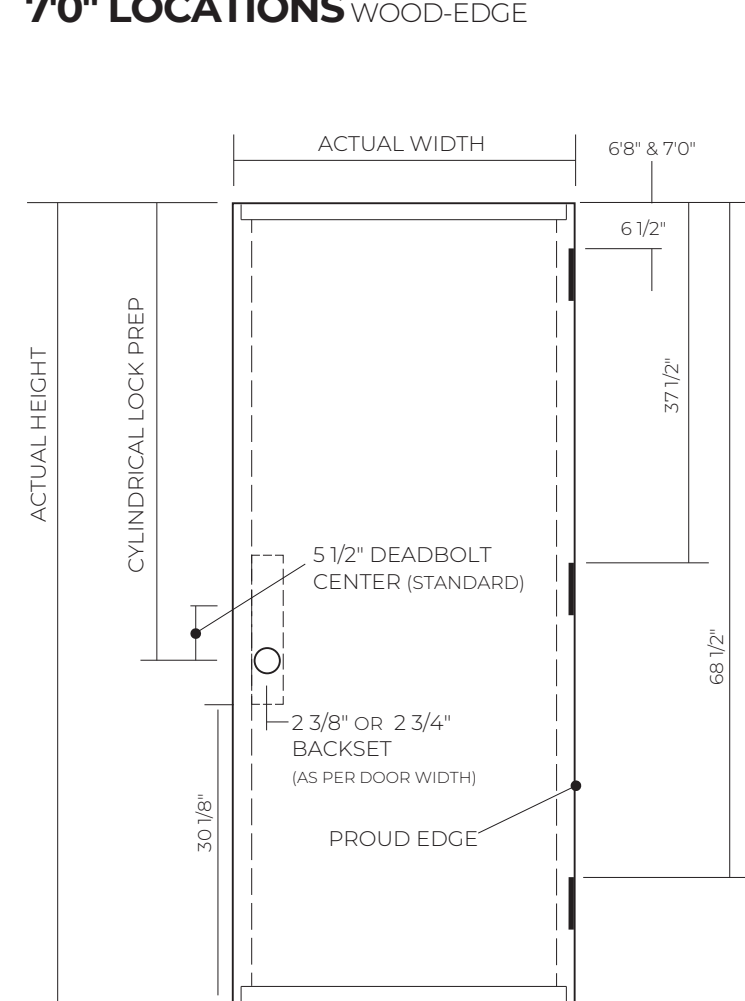

| DOOR HEIGHT |        |                  |
|-------------|--------|------------------|
| NOMINAL     | ACTUAL | CYLINDRICAL PREP |
| 6-8         | 79"    | 45 7/8"          |
| 7-0         | 83"    | 49 7/8"          |

## 8'0" LOCATIONS WOOD-EDGE

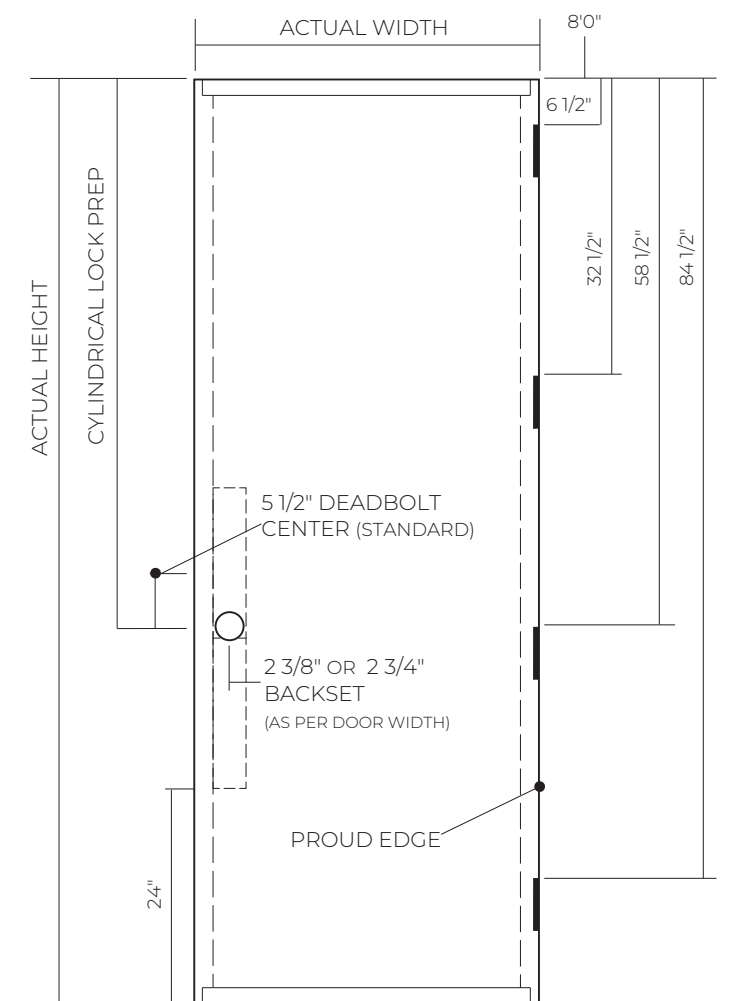

| DOOR HEIGHT |        |                  |
|-------------|--------|------------------|
| NOMINAL     | ACTUAL | CYLINDRICAL PREP |
| 8-0         | 95"    | 59"              |

# EMBOSSMENT PROFILES

STEEL DOORS AND SIDELIGHTS



HD EMBOSMENT

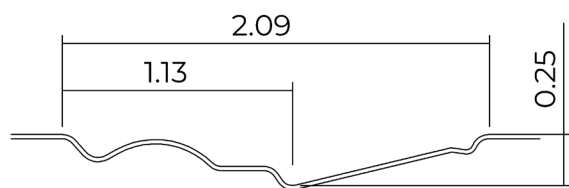

DETAILS EMBOSMENT

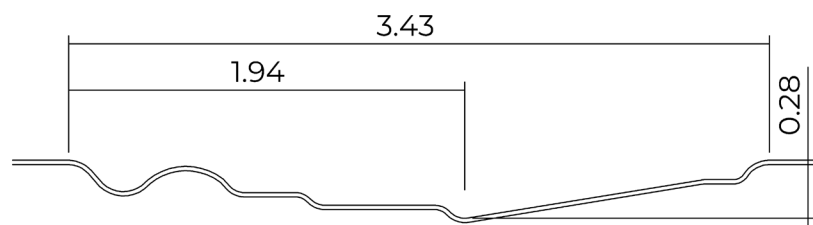

EUROLINE EMBOSMENT

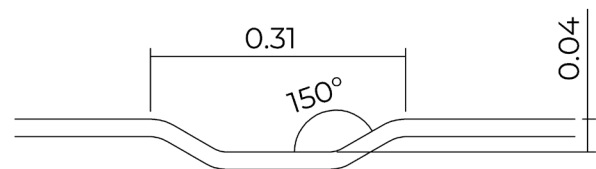

STANDARD EMBOSMENT

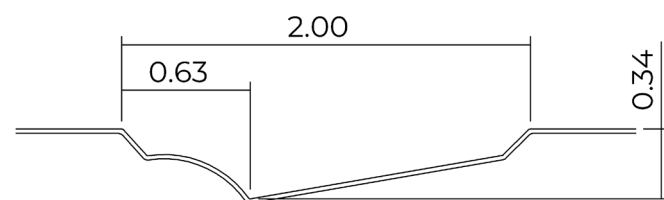

URBAN EMBOSMENT

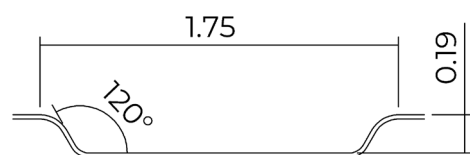

# STEEL MARK® & STEEL MARK® PLUS

WOOD-EDGE AND STEEL EDGE DOORS AND SIDELIGHTS



# 6'8" FLUSH

STEEL DOOR

WOOD EDGE | STEEL PRO®, STEEL MARK® & STEEL MARK® PLUS  
 STEEL EDGE | STEEL MARK® & STEEL MARK® PLUS

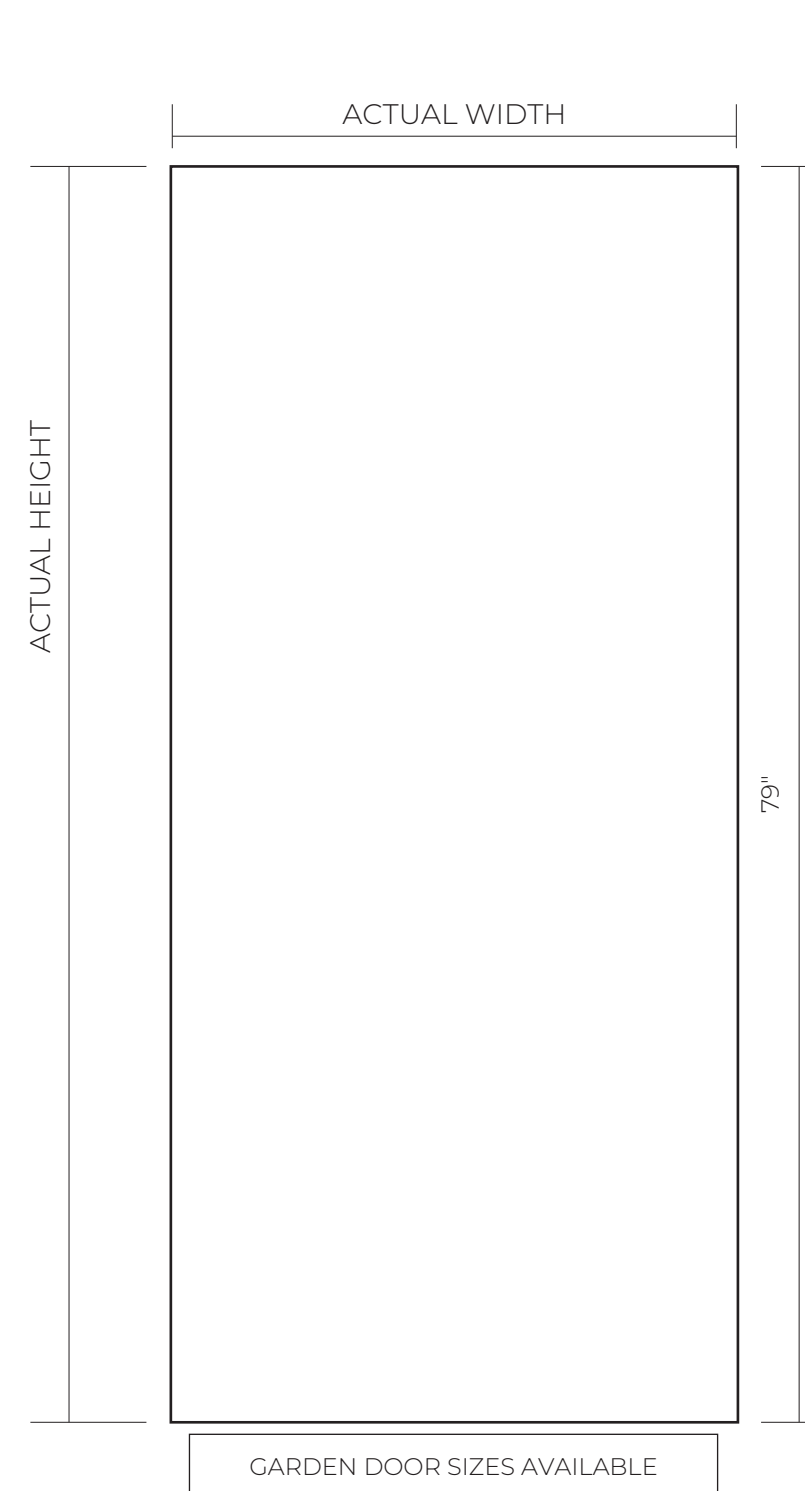

| DOOR WIDTH - WOOD EDGE |         |
|------------------------|---------|
| NOMINAL                | ACTUAL  |
| 2-6                    | 29 3/4" |
| 2-8                    | 31 3/4" |
| 2-10                   | 33 3/4" |
| 3-0                    | 35 3/4" |
| 3-6                    | 41 3/4" |

| DOOR WIDTH - STEEL EDGE |           |
|-------------------------|-----------|
| NOMINAL                 | ACTUAL    |
| 2-6                     | 29 11/16" |
| 2-8                     | 31 11/16" |
| 2-10                    | 33 11/16" |
| 3-0                     | 35 11/16" |
| 3-6                     | 41 11/16" |

| DOOR HEIGHT |        |                  |
|-------------|--------|------------------|
| NOMINAL     | ACTUAL | CYLINDRICAL PREP |
| 6-8         | 79"    | 45 7/8"          |

| GLASS OPTIONS  |              |
|----------------|--------------|
| SIZE           | CUTOUT       |
| 7 x 64         | 8 x 65       |
| 8 x 64         | 9 x 65       |
| 11 x 5 3L      | 12 x 6 3L    |
| 12 x 12 3L     | 13 x 13 3L   |
| 3.5 x 22 5L    | 4.5 x 23 5L  |
| 22 x 10 3L     | 23 x 11 3L   |
| 22 x 36        | 23 x 37      |
| 22 x 36 RT**   | 23 x 37 RT   |
| 22 x 64        | 23 x 65      |
| 22 x 17 3L     | 23 x 18      |
| 20 x 56 oval** | 21 x 57 oval |
| 22 x 64 RT**   | 23 x 65 RT   |
| 14 x 64        | 15 x 65      |

\*\*Refer to page 144-145 for non-rectangular cutout dimensions

# 6'8" 6 PANEL

STEEL DOOR

WOOD EDGE | STEEL PRO®, STEEL MARK® & STEEL MARK® PLUS  
 STEEL EDGE | STEEL MARK® & STEEL MARK® PLUS

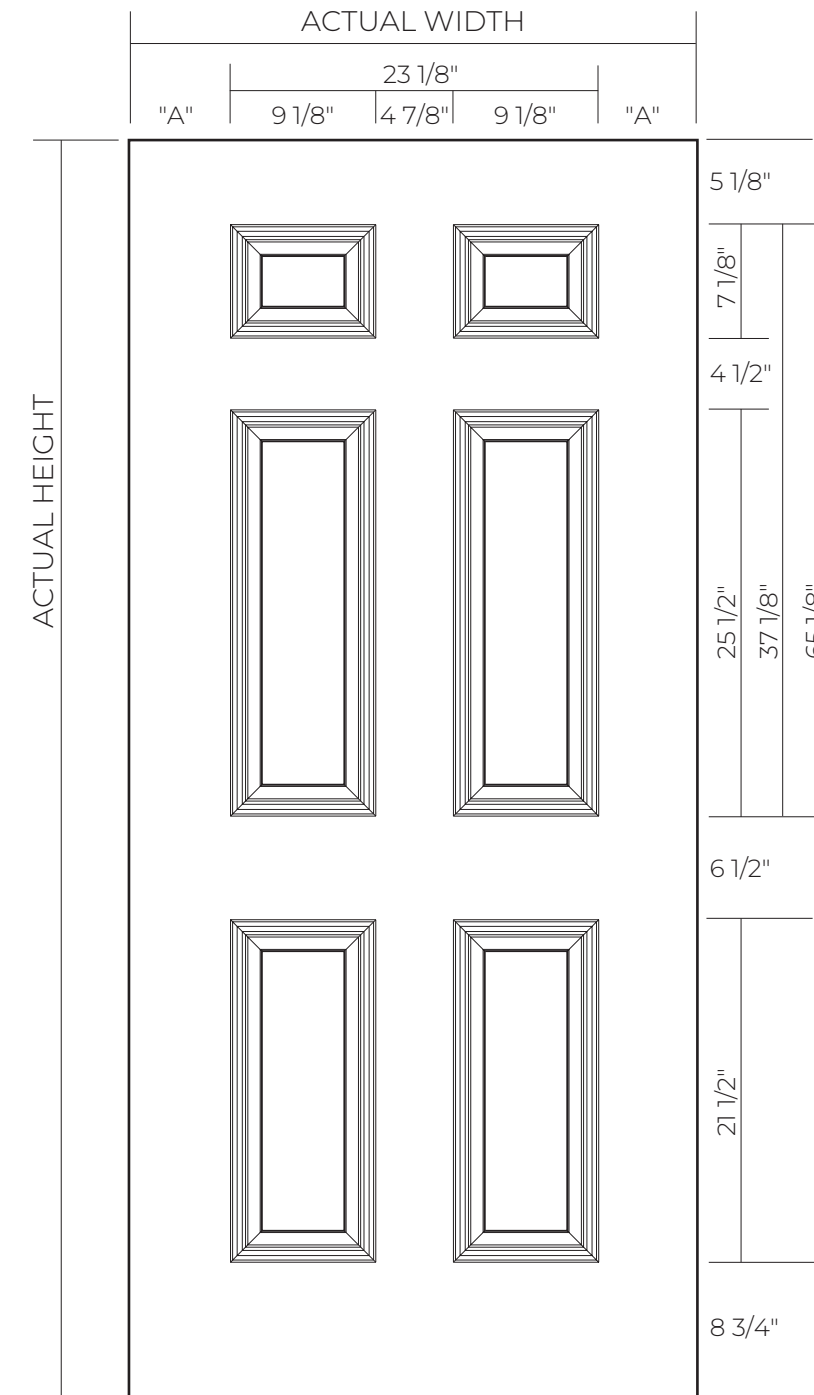

| DOOR WIDTH - WOOD EDGE |         |         |
|------------------------|---------|---------|
| NOMINAL                | ACTUAL  | "A"     |
| 2-8                    | 31 3/4" | 4 5/16" |
| 2-10                   | 33 3/4" | 5 5/16" |
| 3-0                    | 35 3/4" | 6 5/16" |

| DOOR WIDTH - STEEL EDGE |           |         |
|-------------------------|-----------|---------|
| NOMINAL                 | ACTUAL    | "A"     |
| 2-8                     | 31 11/16" | 4 9/32" |
| 2-10                    | 33 11/16" | 5 9/32" |
| 3-0                     | 35 11/16" | 6 9/32" |

| DOOR HEIGHT |        |                  |
|-------------|--------|------------------|
| NOMINAL     | ACTUAL | CYLINDRICAL PREP |
| 6-8         | 79"    | 45 7/8"          |
| 7-0*        | 83"    | 49 7/8"          |

| GLASS OPTIONS |         |
|---------------|---------|
| SIZE          | CUTOUT  |
| 8 x 6 2L      | 9 x 7   |
| 8 x 36 2L     | 9 x 37  |
| 22 x 10       | 23 x 11 |
| 22 x 36       | 23 x 37 |
| 22 x 64       | 23 x 65 |

STEEL MARK® & STEEL MARK® PLUS

STEEL MARK® & STEEL MARK® PLUS

GARDEN DOOR SIZES AVAILABLE

# 6'8" 4 PANEL

STEEL DOOR

WOOD EDGE | **STEEL PRO®**, **STEEL MARK®** & **STEEL MARK® PLUS**  
 STEEL EDGE | **STEEL MARK®** & **STEEL MARK® PLUS**

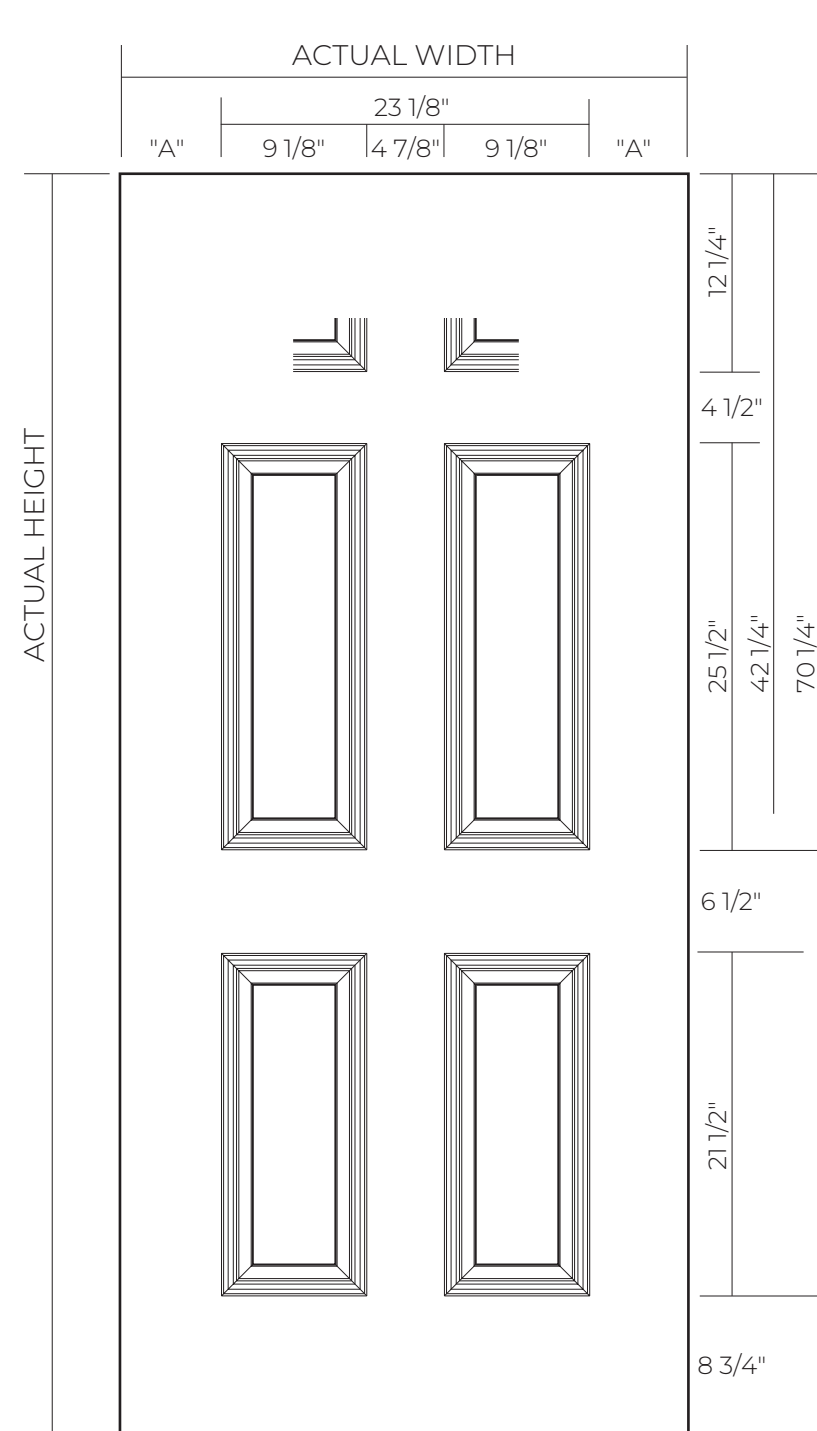

### DOOR WIDTH - WOOD EDGE

| NOMINAL | ACTUAL  | "A"     |
|---------|---------|---------|
| 2-8     | 31 3/4" | 4 5/16" |
| 2-10    | 33 3/4" | 5 5/16" |
| 3-0     | 35 3/4" | 6 5/16" |

### DOOR WIDTH - STEEL EDGE

| NOMINAL | ACTUAL    | "A"     |
|---------|-----------|---------|
| 2-8     | 31 11/16" | 4 9/32" |
| 2-10    | 33 11/16" | 5 9/32" |
| 3-0     | 35 11/16" | 6 9/32" |

### DOOR HEIGHT

| NOMINAL | ACTUAL | CYLINDRICAL PREP |
|---------|--------|------------------|
| 6-8     | 79"    | 45 7/8"          |

### GLASS OPTIONS

| SIZE         | CUTOUT      |
|--------------|-------------|
| 8 x 6 2L     | 9 x 7       |
| 8 x 36 2L    | 9 x 37      |
| 9 x 21 SUN** | 10 x 22 SUN |
| 22 x 10 AT** | 23 x 11 AT  |
| 22 x 36      | 23 x 37     |
| 22 x 36 RT** | 23 x 37 RT  |
| 22 x 38 AT** | 23 x 39 AT  |
| 22 x 64      | 23 x 65     |

\*\*Refer to page 144-145 for non-rectangular cutout dimensions

# 6'8" 3 PANEL

STEEL DOOR

WOOD EDGE | **STEEL MARK®** & **STEEL MARK® PLUS**  
 STEEL EDGE | **STEEL MARK®** & **STEEL MARK® PLUS**

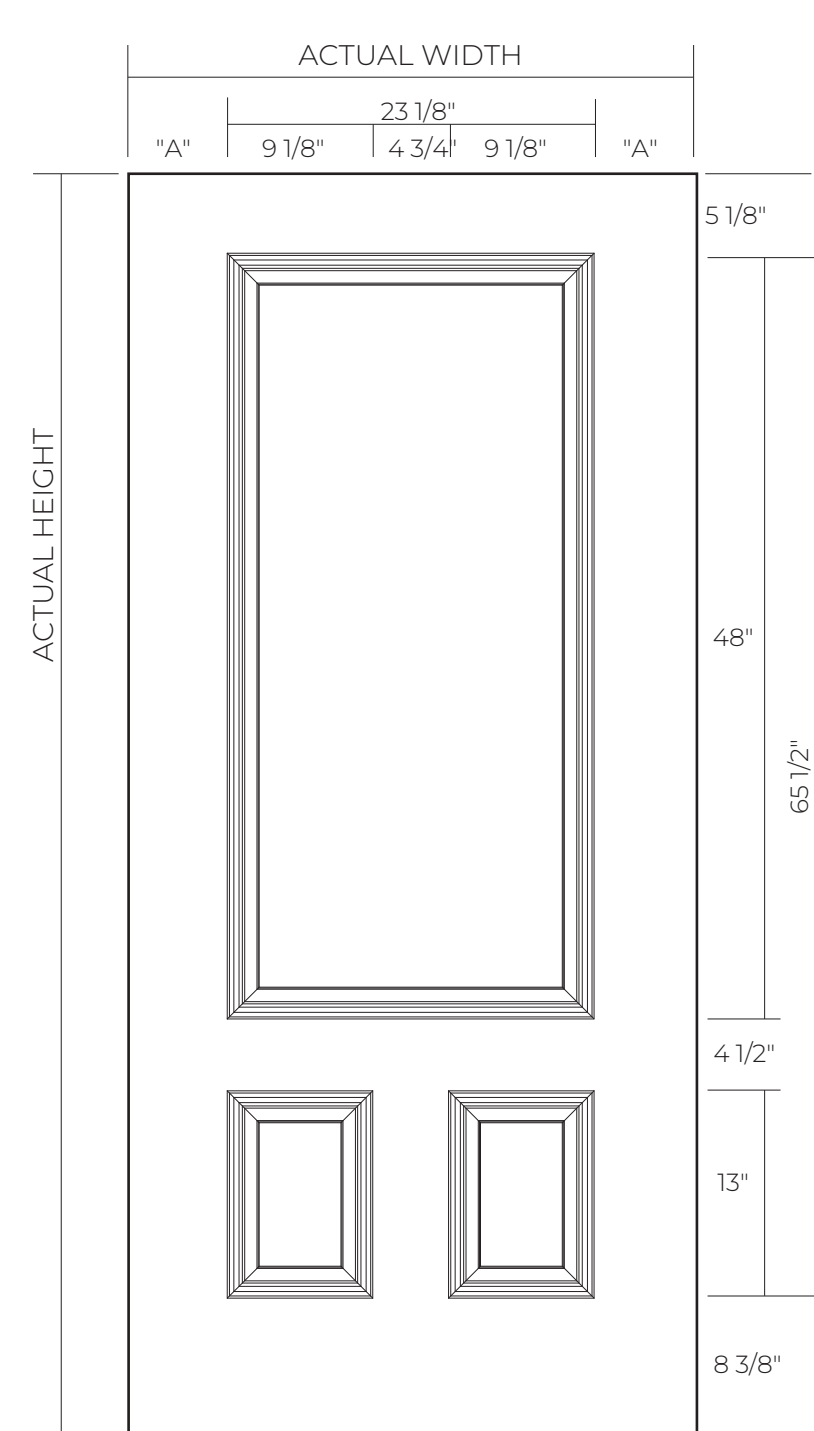

### DOOR WIDTH - WOOD EDGE

| NOMINAL | ACTUAL  | "A"     |
|---------|---------|---------|
| 2-8     | 31 3/4" | 4 5/16" |
| 2-10    | 33 3/4" | 5 5/16" |
| 3-0     | 35 3/4" | 6 5/16" |

### DOOR WIDTH - STEEL EDGE

| NOMINAL | ACTUAL    | "A"     |
|---------|-----------|---------|
| 2-8     | 31 11/16" | 4 9/32" |
| 2-10    | 33 11/16" | 5 9/32" |
| 3-0     | 35 11/16" | 6 9/32" |

### DOOR HEIGHT

| NOMINAL | ACTUAL | CYLINDRICAL PREP |
|---------|--------|------------------|
| 6-8     | 79"    | 45 7/8"          |

### GLASS OPTIONS

| SIZE           | CUTOUT       |
|----------------|--------------|
| 22 x 48        | 23 x 49      |
| 15 x 39 oval** | 16 x 40 oval |

\*\*Refer to page 144-145 for non-rectangular cutout dimensions

STEEL MARK® & STEEL MARK® PLUS

STEEL MARK® & STEEL MARK® PLUS



# 6'8" 2 PANEL 3/4 TOP

STEEL DOOR

WOOD EDGE | STEEL MARK® & STEEL MARK® PLUS  
STEEL EDGE | STEEL MARK® & STEEL MARK® PLUS

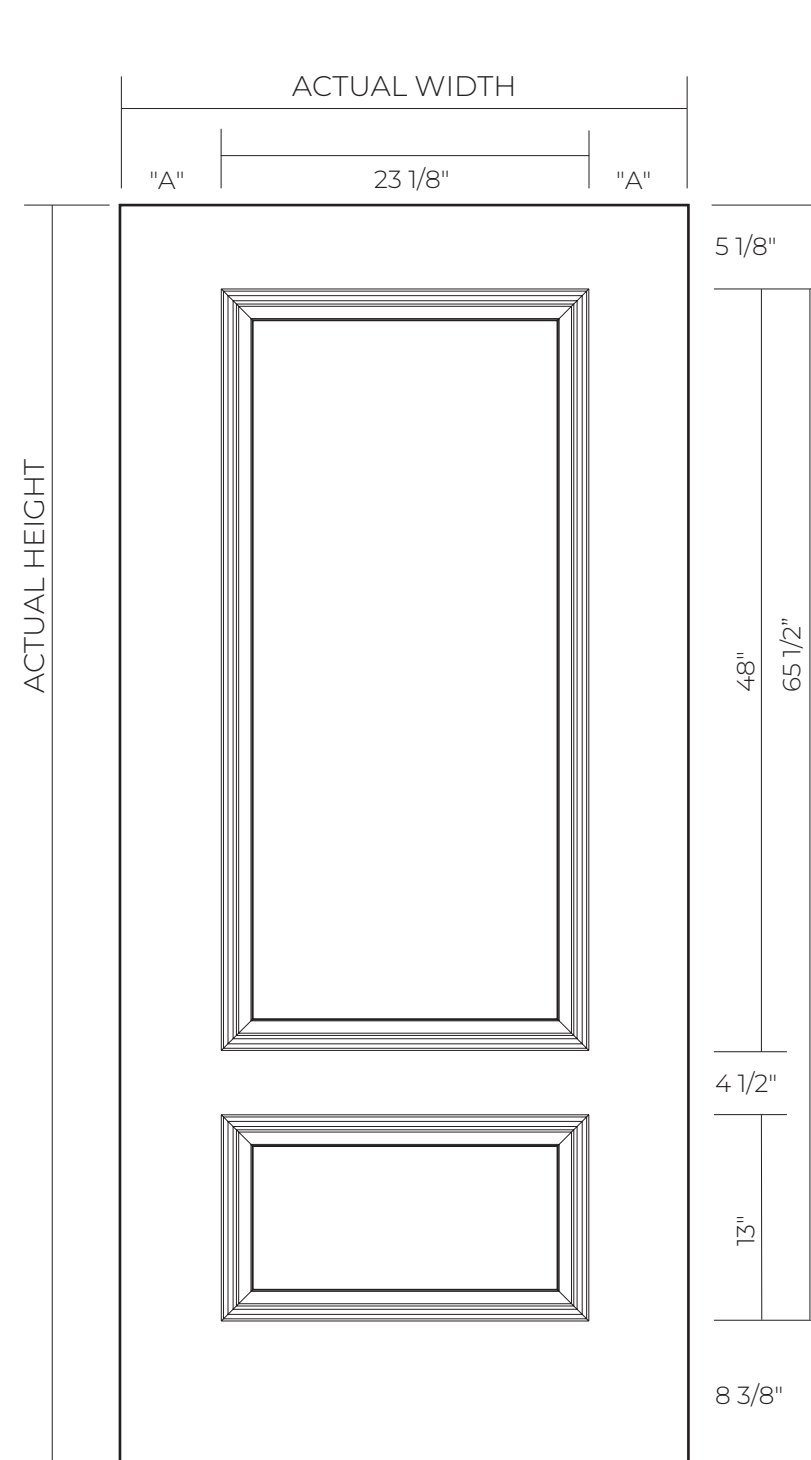

### DOOR WIDTH - WOOD EDGE

| NOMINAL | ACTUAL  | "A"     |
|---------|---------|---------|
| 2-8     | 31 3/4" | 4 5/16" |
| 2-10    | 33 3/4" | 5 5/16" |
| 3-0     | 35 3/4" | 6 5/16" |

### DOOR WIDTH - STEEL EDGE

| NOMINAL | ACTUAL    | "A"     |
|---------|-----------|---------|
| 2-8     | 31 11/16" | 4 9/32" |
| 2-10    | 33 11/16" | 5 9/32" |
| 3-0     | 35 11/16" | 6 9/32" |

### DOOR HEIGHT

| NOMINAL | ACTUAL | CYLINDRICAL PREP |
|---------|--------|------------------|
| 6-8     | 79"    | 45 7/8"          |

### GLASS OPTIONS

| SIZE           | CUTOUT       |
|----------------|--------------|
| 22 x 48        | 23 x 49      |
| 22 x 64        | 23 x 65      |
| 15 x 39 oval** | 16 x 40 oval |

\*\*Refer to page 144-145 for non-rectangular cutout dimensions

# 6'8" 2 PANEL SQUARE

STEEL DOOR

WOOD EDGE | STEEL MARK® & STEEL MARK® PLUS  
STEEL EDGE | STEEL MARK® & STEEL MARK® PLUS

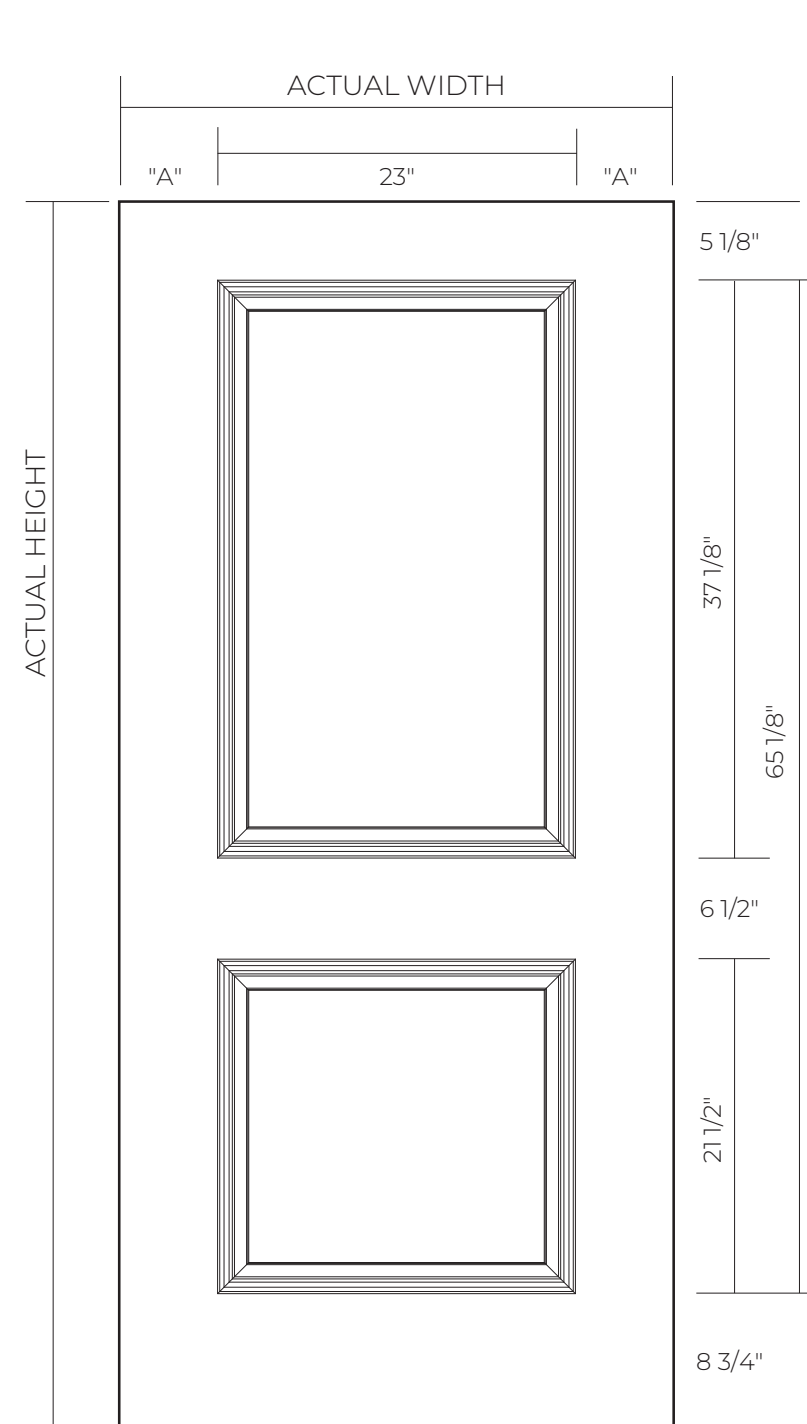

### DOOR WIDTH - WOOD EDGE

| NOMINAL | ACTUAL  | "A"    |
|---------|---------|--------|
| 2-8     | 31 3/4" | 4 3/8" |
| 2-10    | 33 3/4" | 5 3/8" |
| 3-0     | 35 3/4" | 6 3/8" |

### DOOR WIDTH - STEEL EDGE

| NOMINAL | ACTUAL    | "A"      |
|---------|-----------|----------|
| 2-8     | 31 11/16" | 4 11/32" |
| 2-10    | 33 11/16" | 5 11/32" |
| 3-0     | 35 11/16" | 6 11/32" |

### DOOR HEIGHT

| NOMINAL | ACTUAL | CYLINDRICAL PREP |
|---------|--------|------------------|
| 6-8     | 79"    | 45 7/8"          |

### GLASS OPTIONS

| SIZE    | CUTOUT  |
|---------|---------|
| 22 x 36 | 23 x 37 |
| 22 x 64 | 23 x 65 |

STEEL MARK® & STEEL MARK® PLUS

STEEL MARK® & STEEL MARK® PLUS

# 6'8" 2 PANEL CAMBER

STEEL DOOR

WOOD EDGE | STEEL MARK® & STEEL MARK® PLUS  
STEEL EDGE | STEEL MARK® & STEEL MARK® PLUS



### DOOR WIDTH - WOOD EDGE

| NOMINAL | ACTUAL  | "A"    |
|---------|---------|--------|
| 2-8     | 31 3/4" | 4 3/8" |
| 2-10    | 33 3/4" | 5 3/8" |
| 3-0     | 35 3/4" | 6 3/8" |

### DOOR WIDTH - STEEL EDGE

| NOMINAL | ACTUAL    | "A"      |
|---------|-----------|----------|
| 2-8     | 31 11/16" | 4 11/32" |
| 2-10    | 33 11/16" | 5 11/32" |
| 3-0     | 35 11/16" | 6 11/32" |

### DOOR HEIGHT

| NOMINAL | ACTUAL | CYLINDRICAL PREP |
|---------|--------|------------------|
| 6-8     | 79"    | 45 7/8"          |

### GLASS OPTIONS

| SIZE         | CUTOUT     |
|--------------|------------|
| 22 x 36      | 23 x 37    |
| 22 x 38 AT** | 23 x 39 AT |
| 22 x 64      | 23 x 65    |



\*\*Refer to page 144-145 for non-rectangular cutout dimensions

# 6'8" 2 PANEL CAMBER PLANK

STEEL DOOR

WOOD EDGE | STEEL MARK® & STEEL MARK® PLUS  
STEEL EDGE | STEEL MARK® & STEEL MARK® PLUS



### DOOR WIDTH - WOOD EDGE

| NOMINAL | ACTUAL  | "A"    |
|---------|---------|--------|
| 2-8     | 31 3/4" | 4 3/8" |
| 2-10    | 33 3/4" | 5 3/8" |
| 3-0     | 35 3/4" | 6 3/8" |

### DOOR WIDTH - STEEL EDGE

| NOMINAL | ACTUAL    | "A"      |
|---------|-----------|----------|
| 2-8     | 31 11/16" | 4 11/32" |
| 2-10    | 33 11/16" | 5 11/32" |
| 3-0     | 35 11/16" | 6 11/32" |

### DOOR HEIGHT

| NOMINAL | ACTUAL | CYLINDRICAL PREP |
|---------|--------|------------------|
| 6-8     | 79"    | 45 7/8"          |

### GLASS OPTIONS

| SIZE         | CUTOUT     |
|--------------|------------|
| 22 x 36      | 23 x 37    |
| 22 x 38 AT** | 23 x 39 AT |
| 22 x 64      | 23 x 65    |



\*\*Refer to page 144-145 for non-rectangular cutout dimensions

STEEL MARK® & STEEL MARK® PLUS

STEEL MARK® & STEEL MARK® PLUS

# 6'8" EUROLINE 6

STEEL DOOR

WOOD EDGE | STEEL MARK® & STEEL MARK® PLUS  
 STEEL EDGE | STEEL MARK® & STEEL MARK® PLUS

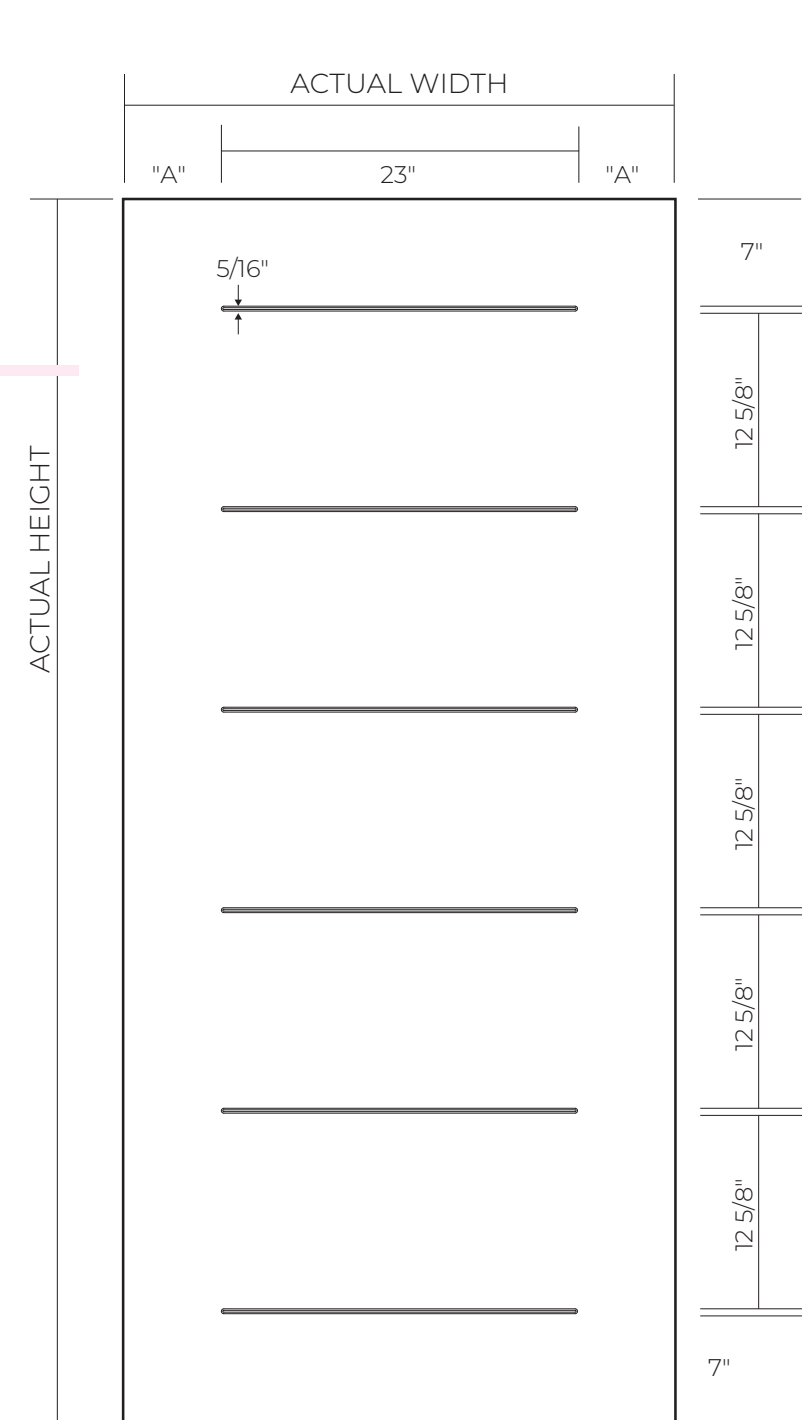

### DOOR WIDTH - WOOD EDGE

| NOMINAL | ACTUAL  | "A"    |
|---------|---------|--------|
| 2-8     | 31 3/4" | 4 3/8" |
| 2-10    | 33 3/4" | 5 3/8" |
| 3-0     | 35 3/4" | 6 3/8" |

### DOOR WIDTH - STEEL EDGE

| NOMINAL | ACTUAL    | "A"      |
|---------|-----------|----------|
| 2-8     | 31 11/16" | 4 11/32" |
| 2-10    | 33 11/16" | 5 11/32" |
| 3-0     | 35 11/16" | 6 11/32" |

### DOOR HEIGHT

| NOMINAL | ACTUAL | CYLINDRICAL PREP |
|---------|--------|------------------|
| 6-8     | 79"    | 45 7/8"          |

# 6'8" 4 PANEL URBAN

STEEL DOOR

WOOD EDGE | STEEL MARK® & STEEL MARK® PLUS  
 STEEL EDGE | STEEL MARK® & STEEL MARK® PLUS

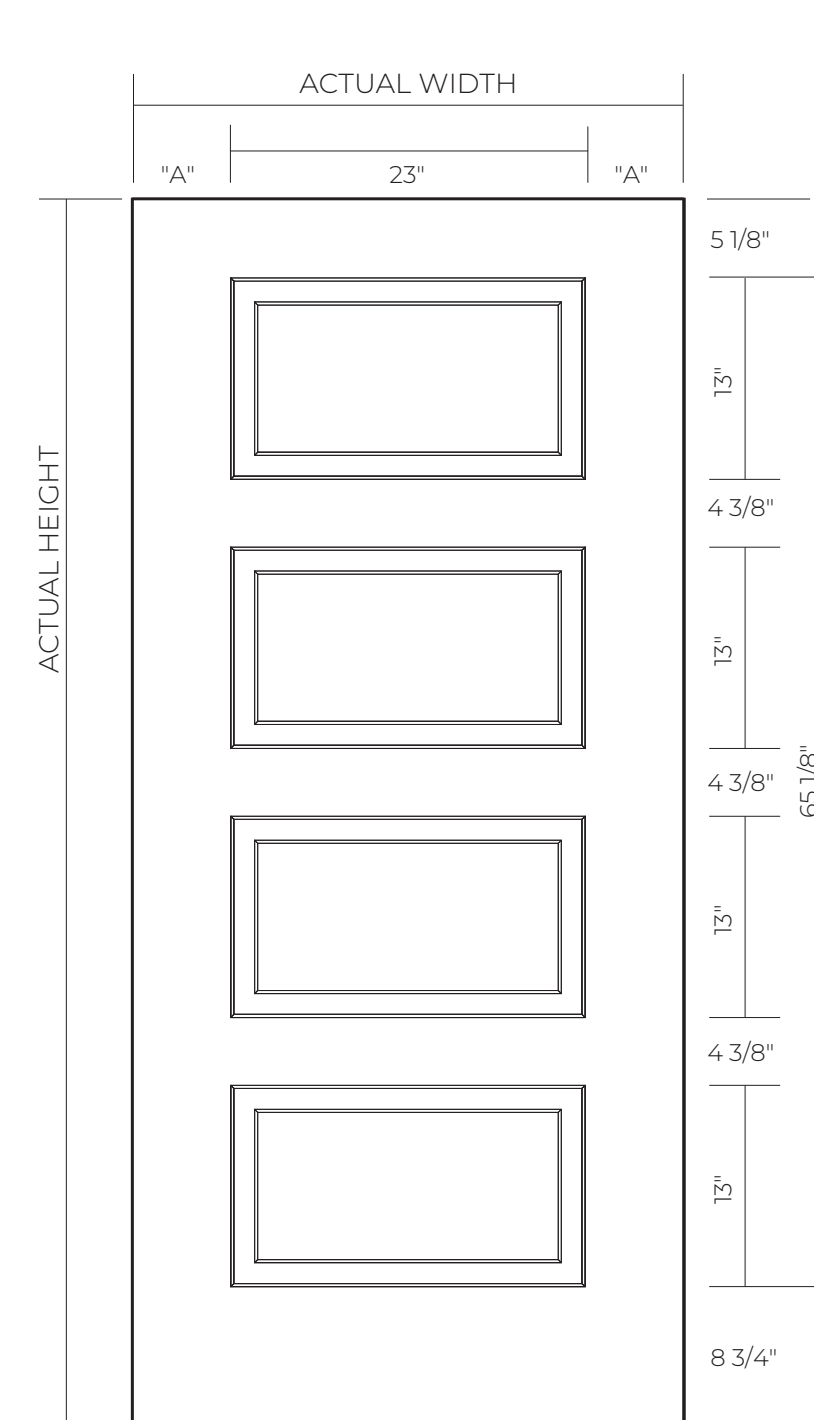

### DOOR WIDTH - WOOD EDGE

| NOMINAL | ACTUAL  | "A"    |
|---------|---------|--------|
| 2-8     | 31 3/4" | 4 3/8" |
| 2-10    | 33 3/4" | 5 3/8" |
| 3-0     | 35 3/4" | 6 3/8" |

### DOOR WIDTH - STEEL EDGE

| NOMINAL | ACTUAL    | "A"      |
|---------|-----------|----------|
| 2-8     | 31 11/16" | 4 11/32" |
| 2-10    | 33 11/16" | 5 11/32" |
| 3-0     | 35 11/16" | 6 11/32" |

### DOOR HEIGHT

| NOMINAL | ACTUAL | CYLINDRICAL PREP |
|---------|--------|------------------|
| 6-8     | 79"    | 45 7/8"          |

### GLASS OPTIONS

| SIZE    | CUTOUT  |
|---------|---------|
| 22 x 48 | 23 x 49 |
| 22 x 64 | 23 x 65 |

STEEL MARK® & STEEL MARK® PLUS

STEEL MARK® & STEEL MARK® PLUS

# 6'8" 3 PANEL URBAN

STEEL DOOR

WOOD EDGE | **STEEL MARK® & STEEL MARK® PLUS**  
 STEEL EDGE | **STEEL MARK® & STEEL MARK® PLUS**

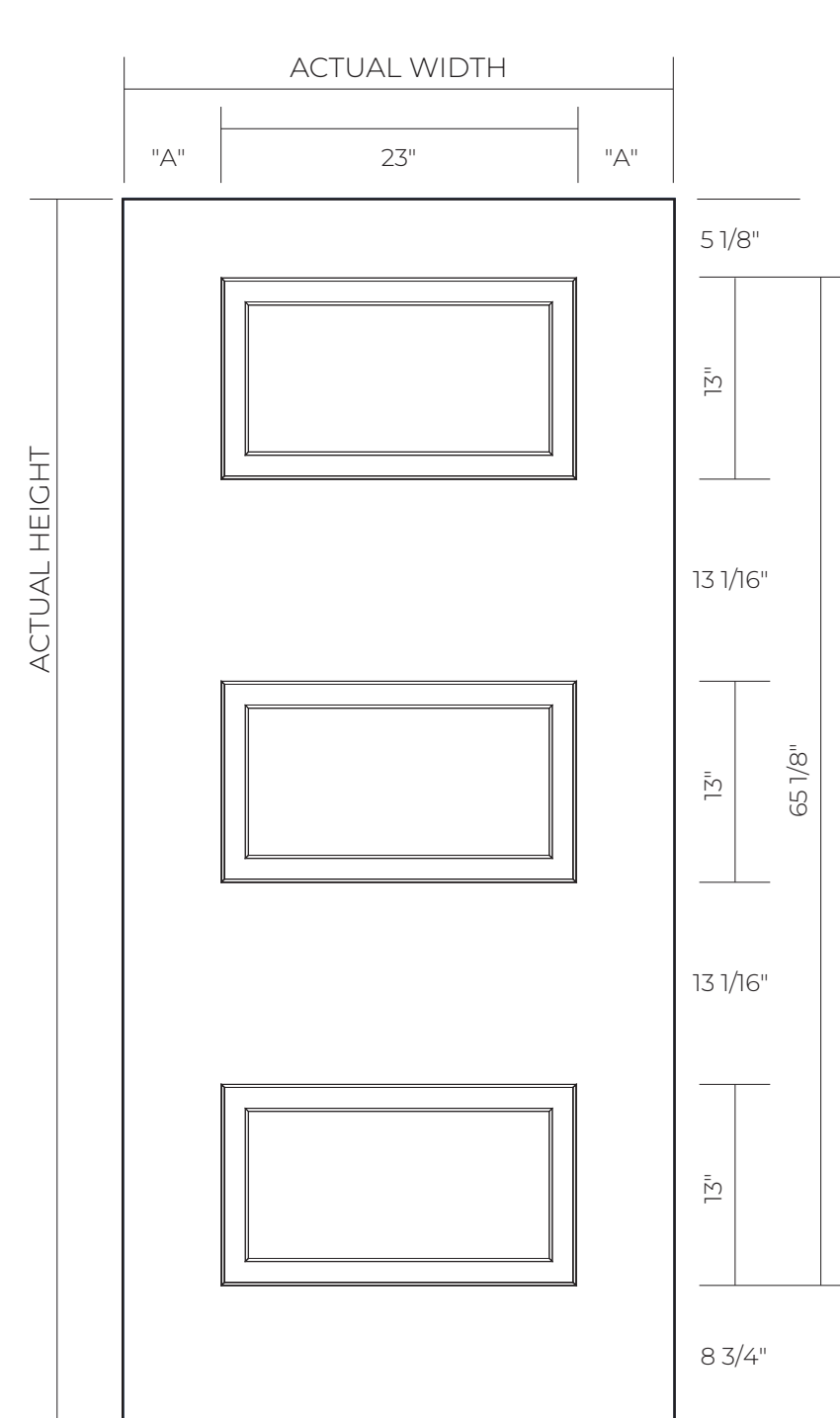

| DOOR WIDTH - WOOD EDGE |         |        |
|------------------------|---------|--------|
| NOMINAL                | ACTUAL  | "A"    |
| 2-8                    | 31 3/4" | 4 3/8" |
| 2-10                   | 33 3/4" | 5 3/8" |
| 3-0                    | 35 3/4" | 6 3/8" |

| DOOR WIDTH - STEEL EDGE |           |          |
|-------------------------|-----------|----------|
| NOMINAL                 | ACTUAL    | "A"      |
| 2-8                     | 31 11/16" | 4 11/32" |
| 2-10                    | 33 11/16" | 5 11/32" |
| 3-0                     | 35 11/16" | 6 11/32" |

| DOOR HEIGHT |        |                  |
|-------------|--------|------------------|
| NOMINAL     | ACTUAL | CYLINDRICAL PREP |
| 6-8         | 79"    | 45 7/8"          |

| GLASS OPTIONS |         |
|---------------|---------|
| SIZE          | CUTOUT  |
| 22 x 48       | 23 x 49 |
| 22 x 64       | 23 x 65 |



# 6'8" 3 PANEL URBAN CRAFTSMAN

STEEL DOOR

WOOD EDGE | **STEEL MARK® & STEEL MARK® PLUS**  
 STEEL EDGE | **STEEL MARK® & STEEL MARK® PLUS**

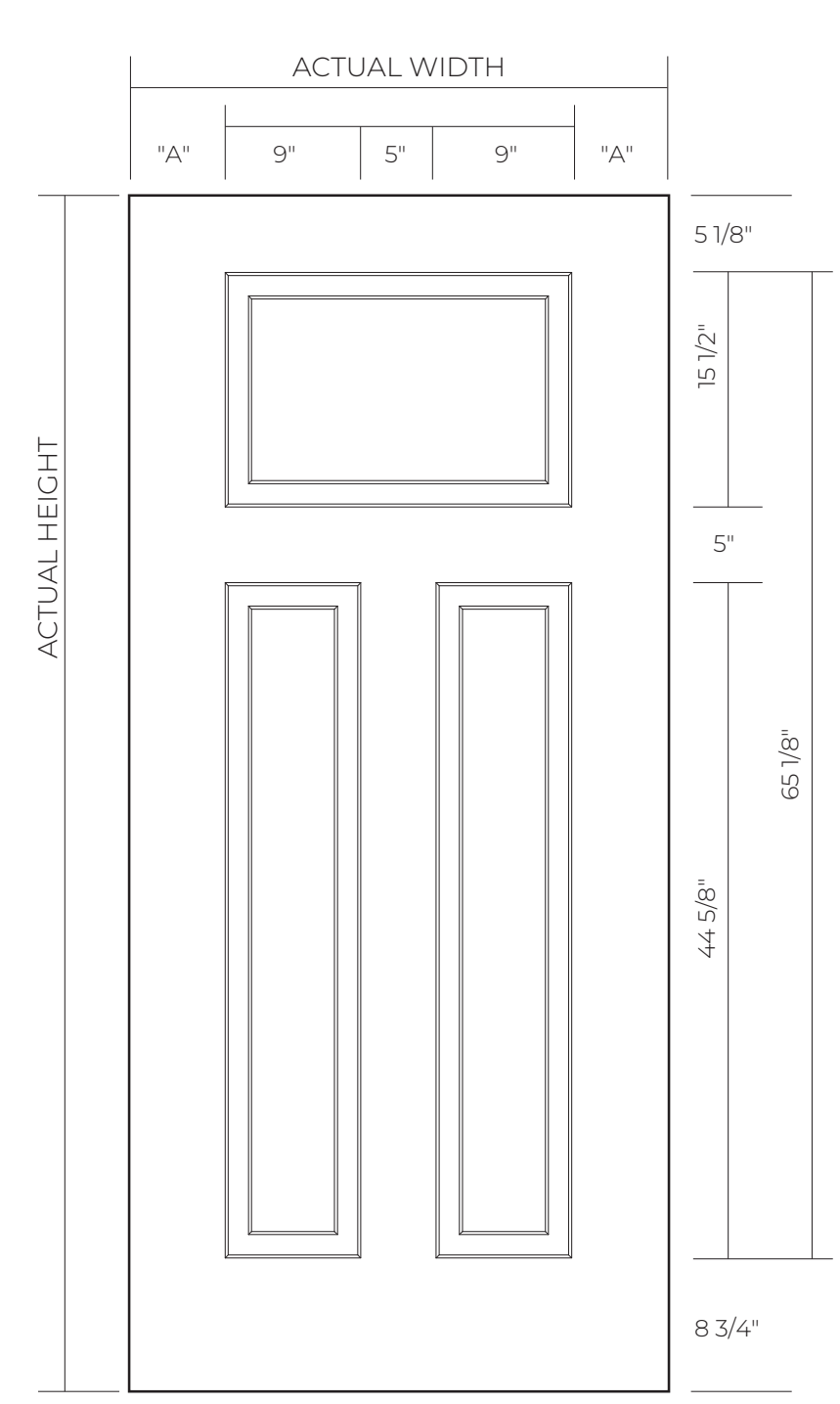

| DOOR WIDTH - WOOD EDGE |         |        |
|------------------------|---------|--------|
| NOMINAL                | ACTUAL  | "A"    |
| 2-8                    | 31 3/4" | 4 3/8" |
| 2-10                   | 33 3/4" | 5 3/8" |
| 3-0                    | 35 3/4" | 6 3/8" |

| DOOR WIDTH - STEEL EDGE |           |          |
|-------------------------|-----------|----------|
| NOMINAL                 | ACTUAL    | "A"      |
| 2-8                     | 31 11/16" | 4 11/32" |
| 2-10                    | 33 11/16" | 5 11/32" |
| 3-0                     | 35 11/16" | 6 11/32" |

| DOOR HEIGHT |        |                  |
|-------------|--------|------------------|
| NOMINAL     | ACTUAL | CYLINDRICAL PREP |
| 6-8         | 79"    | 45 7/8"          |

| GLASS OPTIONS |         |
|---------------|---------|
| SIZE          | CUTOUT  |
| 22 x 17       | 23x 18  |
| 22 x 64       | 23 x 65 |



STEEL MARK® & STEEL MARK® PLUS

STEEL MARK® & STEEL MARK® PLUS

# 6'8" FLUSH

## STEEL SIDELIGHT

WOOD EDGE | STEEL MARK® & STEEL MARK® PLUS

STEEL MARK® & STEEL MARK® PLUS

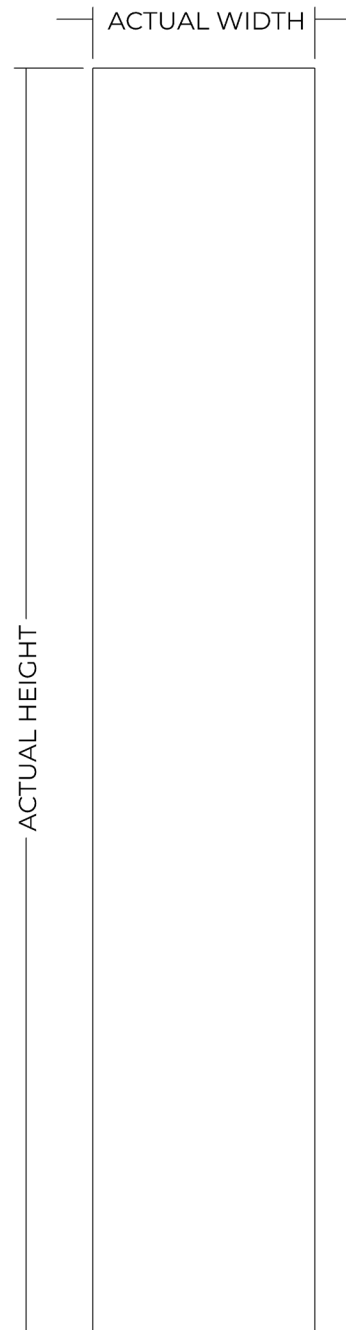

| SIDELIGHT WIDTH - WOOD EDGE |         |
|-----------------------------|---------|
| NOMINAL                     | ACTUAL  |
| 1-0                         | 11 7/8" |
| 1-2                         | 13 7/8" |
| 1-6                         | 17 7/8" |

| SIDELIGHT HEIGHT |        |
|------------------|--------|
| NOMINAL          | ACTUAL |
| 6-8              | 79"    |

| GLASS OPTIONS |        |
|---------------|--------|
| SIZE          | CUTOUT |
| 7 x 64        | 8 x 65 |
| 8 x 64        | 9 x 65 |

# 6'8" 2 PANEL REVERSE

## STEEL SIDELIGHT

WOOD EDGE | STEEL MARK® & STEEL MARK® PLUS

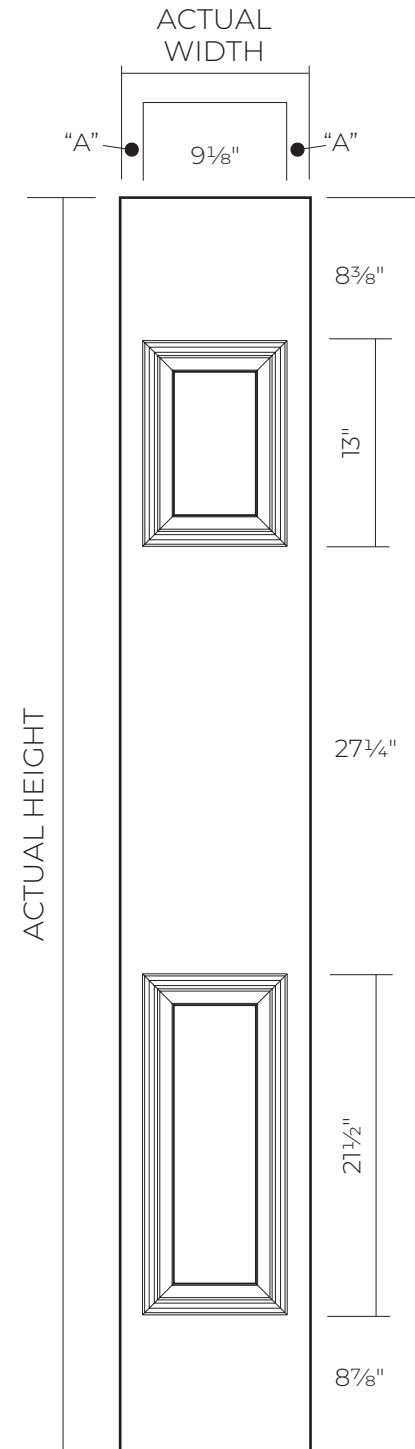

| SIDELIGHT WIDTH - WOOD EDGE |         |          |
|-----------------------------|---------|----------|
| NOMINAL                     | ACTUAL  | "A"      |
| 1-0                         | 11 7/8" | 17 7/16" |
| 1-2                         | 13 7/8" | 27 7/16" |
| 1-6                         | 17 7/8" | 47 7/16" |

| SIDELIGHT HEIGHT |        |
|------------------|--------|
| NOMINAL          | ACTUAL |
| 6-8              | 79"    |

| GLASS OPTIONS |        |
|---------------|--------|
| SIZE          | CUTOUT |
| 8 x 36        | 9 x 37 |
| 8 x 64        | 9 x 65 |

STEEL MARK® & STEEL MARK® PLUS

# 6'8" 2 PANEL REVERSE

STEEL SIDELIGHT

WOOD EDGE | STEEL MARK® & STEEL MARK® PLUS

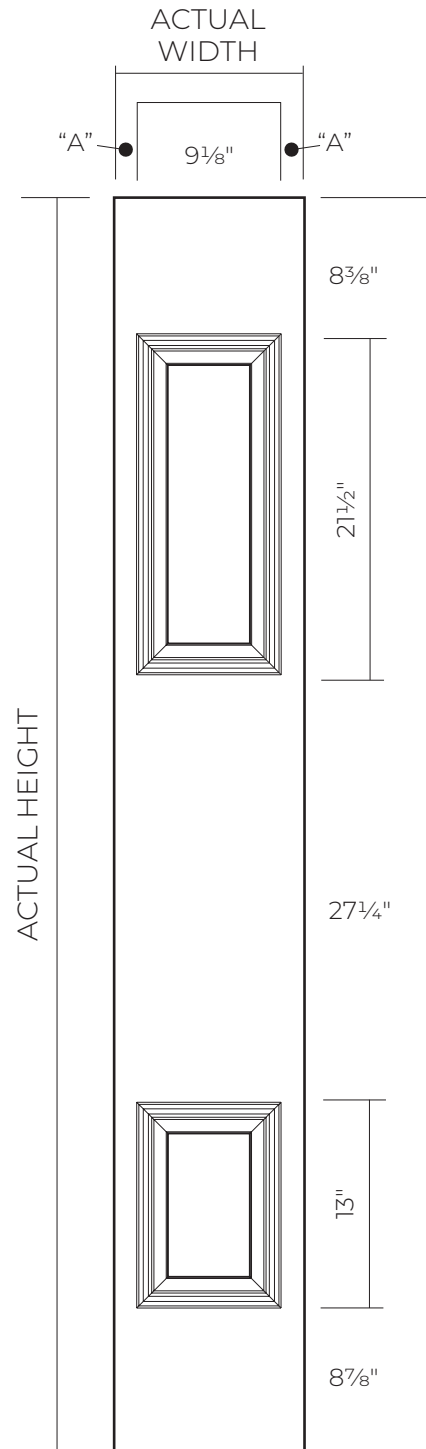

### SIDELIGHT WIDTH - WOOD EDGE

| NOMINAL | ACTUAL  | "A"     |
|---------|---------|---------|
| 1-0     | 11 7/8" | 1 7/16" |
| 1-2     | 13 7/8" | 2 7/16" |
| 1-6     | 17 7/8" | 4 7/16" |

### SIDELIGHT HEIGHT

| NOMINAL | ACTUAL |
|---------|--------|
| 6-8     | 79"    |

### GLASS OPTIONS

| SIZE   | CUTOUT |
|--------|--------|
| 8 x 48 | 9 x 49 |
| 8 x 64 | 9 x 65 |

# 6'8" FLUSH w/1 LIGHT CUTOUT

STEEL SIDELIGHT

WOOD EDGE | STEEL MARK® & STEEL MARK® PLUS

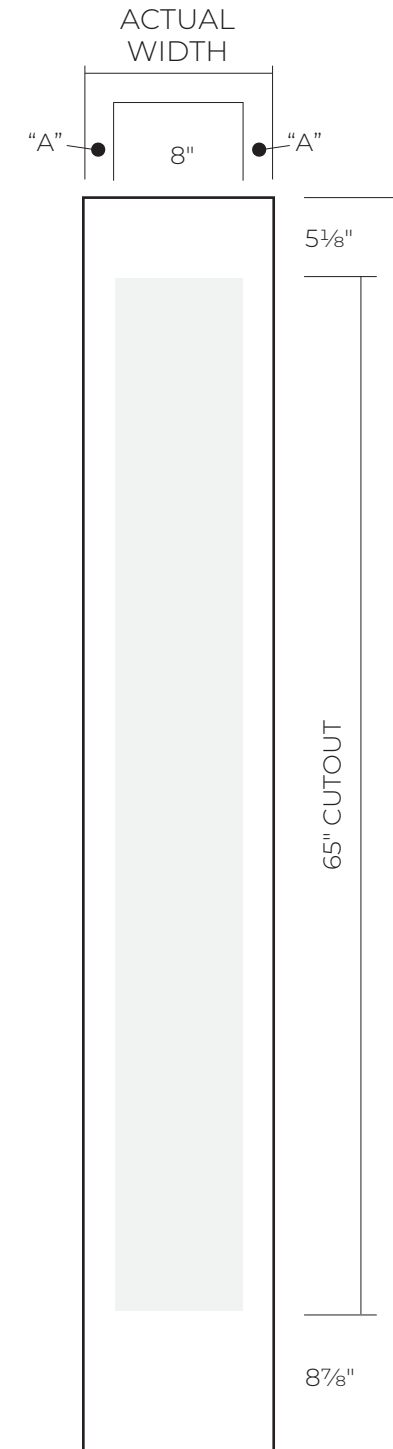

### SIDELIGHT WIDTH - WOOD EDGE

| NOMINAL | ACTUAL  | "A"     |
|---------|---------|---------|
| 1-0     | 11 7/8" | 1 7/16" |
| 1-2     | 13 7/8" | 2 7/16" |
| 1-6     | 17 7/8" | 4 7/16" |

### SIDELIGHT HEIGHT

| NOMINAL | ACTUAL |
|---------|--------|
| 6-8     | 79"    |

### GLASS OPTIONS

| SIZE   | CUTOUT |
|--------|--------|
| 7 x 64 | 8 x 65 |

# 6'8" 3/4 LIGHT w/9x49 CUTOUT

STEEL SIDELIGHT

WOOD EDGE | STEEL MARK® & STEEL MARK® PLUS

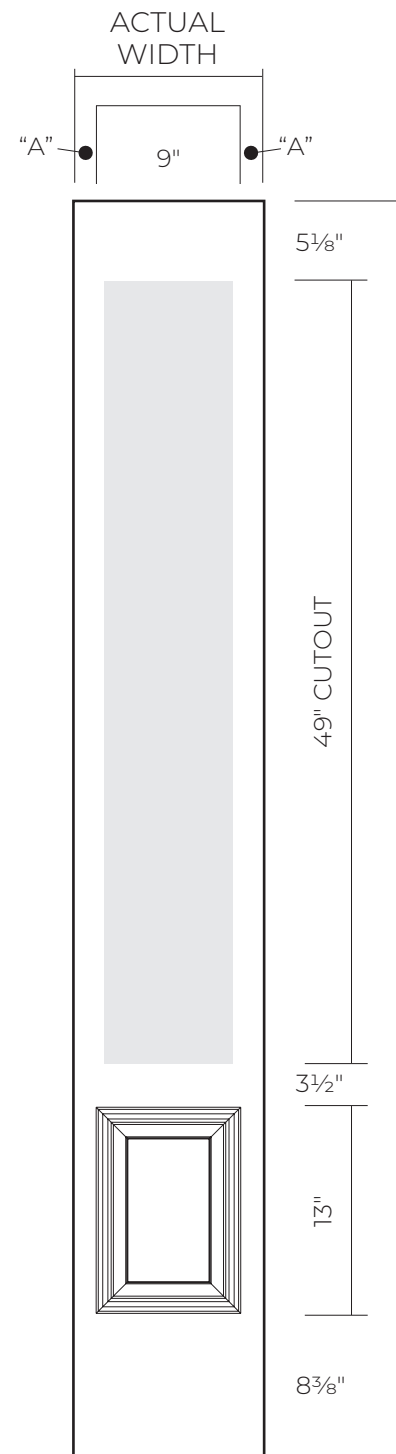

### SIDELIGHT WIDTH - WOOD EDGE

| NOMINAL | ACTUAL                           | "A"                               |
|---------|----------------------------------|-----------------------------------|
| 1-0     | 11 <sup>7</sup> / <sub>8</sub> " | 17 <sup>1</sup> / <sub>16</sub> " |
| 1-2     | 13 <sup>7</sup> / <sub>8</sub> " | 27 <sup>1</sup> / <sub>16</sub> " |
| 1-6     | 17 <sup>7</sup> / <sub>8</sub> " | 47 <sup>1</sup> / <sub>16</sub> " |

### SIDELIGHT HEIGHT

| NOMINAL | ACTUAL |
|---------|--------|
| 6-8     | 79"    |

### GLASS OPTIONS

| SIZE   | CUTOUT |
|--------|--------|
| 8 x 48 | 9 x 49 |

# 6'8" 1/2 LIGHT w/9x37 CUTOUT

STEEL SIDELIGHT

WOOD EDGE | STEEL MARK® & STEEL MARK® PLUS

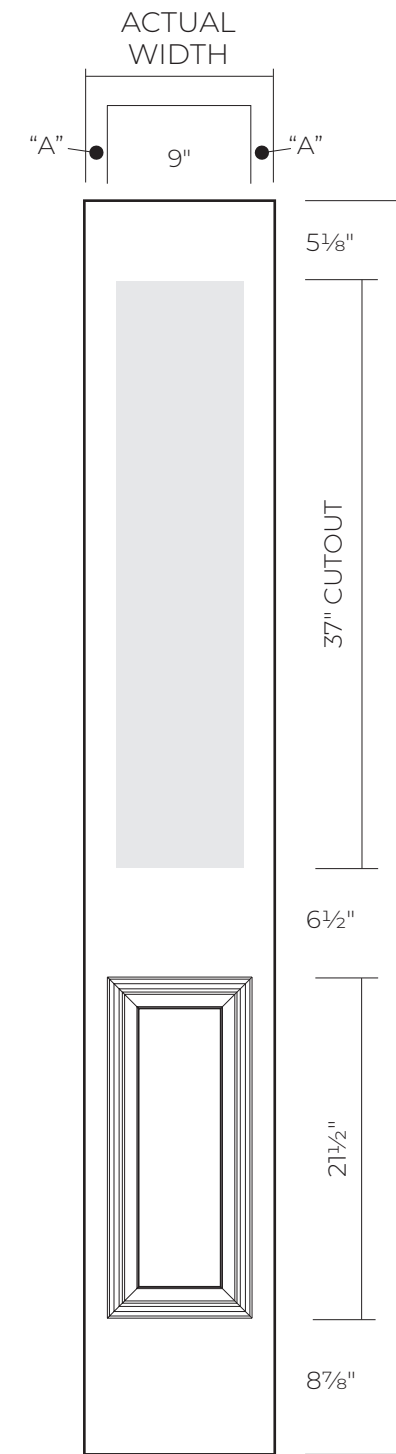

### SIDELIGHT WIDTH - WOOD EDGE

| NOMINAL | ACTUAL                           | "A"                               |
|---------|----------------------------------|-----------------------------------|
| 1-0     | 11 <sup>7</sup> / <sub>8</sub> " | 17 <sup>1</sup> / <sub>16</sub> " |
| 1-2     | 13 <sup>7</sup> / <sub>8</sub> " | 27 <sup>1</sup> / <sub>16</sub> " |
| 1-6     | 17 <sup>7</sup> / <sub>8</sub> " | 47 <sup>1</sup> / <sub>16</sub> " |

### SIDELIGHT HEIGHT

| NOMINAL | ACTUAL |
|---------|--------|
| 6-8     | 79"    |

### GLASS OPTIONS

| SIZE   | CUTOUT |
|--------|--------|
| 8 x 36 | 9 x 37 |

STEEL MARK® & STEEL MARK® PLUS

STEEL MARK® & STEEL MARK® PLUS

# 6'8" 3/4 URBAN w/9x49 CUTOUT

STEEL SIDELIGHT

WOOD EDGE | STEEL MARK® & STEEL MARK® PLUS

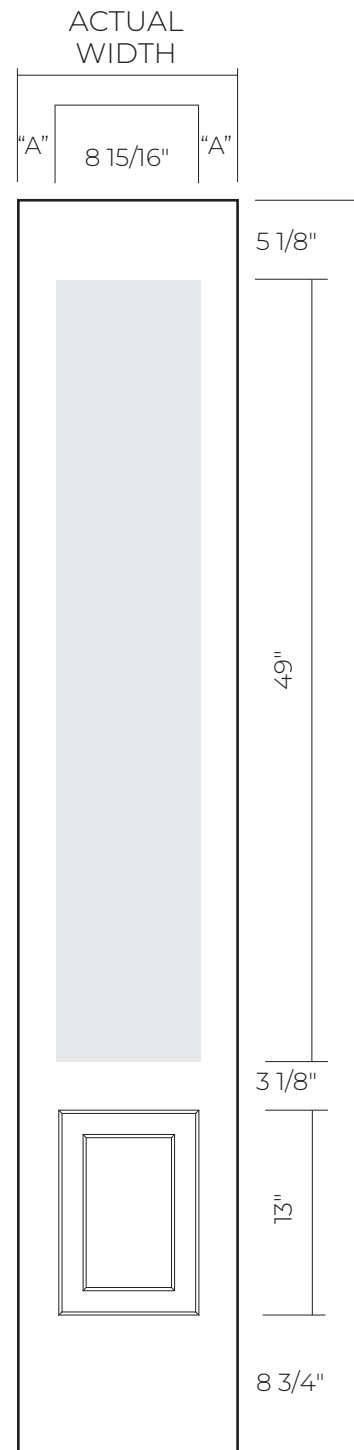

### SIDELIGHT WIDTH - WOOD EDGE

| NOMINAL | ACTUAL                           | "A"      |
|---------|----------------------------------|----------|
| 1-0     | 11 <sup>7</sup> / <sub>8</sub> " | 1 15/32" |
| 1-2     | 13 <sup>7</sup> / <sub>8</sub> " | 2 15/32" |
| 1-6     | 17 <sup>7</sup> / <sub>8</sub> " | 4 15/32" |

### SIDELIGHT HEIGHT

| NOMINAL | ACTUAL |
|---------|--------|
| 6-8     | 79"    |

### GLASS OPTIONS

| SIZE   | CUTOUT |
|--------|--------|
| 8 x 48 | 9 x 49 |

# 6'8" 1/4 URBAN w/9x15 1/2 CUTOUT

STEEL SIDELIGHT

WOOD EDGE | STEEL MARK® & STEEL MARK® PLUS

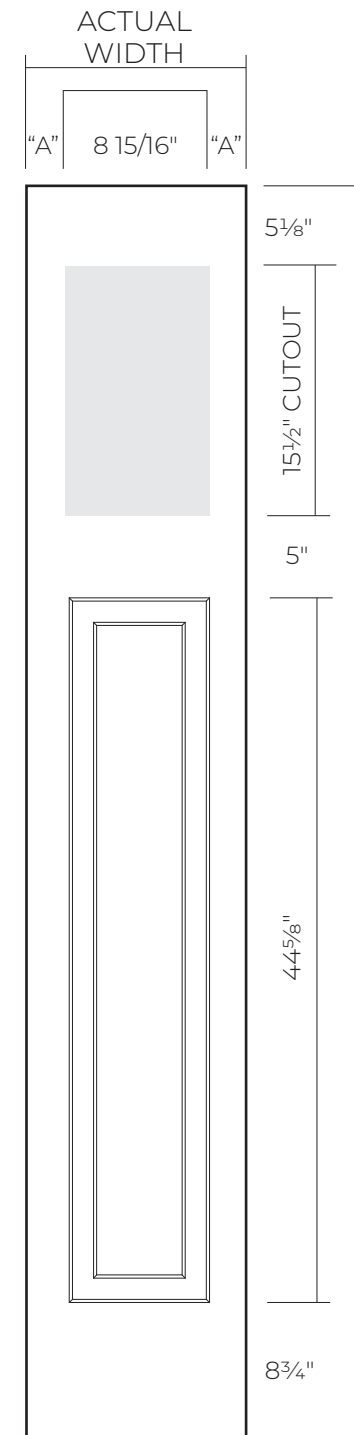

### SIDELIGHT WIDTH - WOOD EDGE

| NOMINAL | ACTUAL                           | "A"      |
|---------|----------------------------------|----------|
| 1-0     | 11 <sup>7</sup> / <sub>8</sub> " | 1 15/32" |
| 1-2     | 13 <sup>7</sup> / <sub>8</sub> " | 2 15/32" |
| 1-6     | 17 <sup>7</sup> / <sub>8</sub> " | 4 15/32" |

### SIDELIGHT HEIGHT

| NOMINAL | ACTUAL |
|---------|--------|
| 6-8     | 79"    |

### GLASS OPTIONS

| SIZE   | CUTOUT |
|--------|--------|
| 8 x 17 | 9 x 18 |

STEEL MARK® & STEEL MARK® PLUS

STEEL MARK® & STEEL MARK® PLUS



# 7'0" FLUSH

STEEL DOOR

WOOD EDGE | STEEL MARK® & STEEL MARK® PLUS

STEEL MARK® & STEEL MARK® PLUS

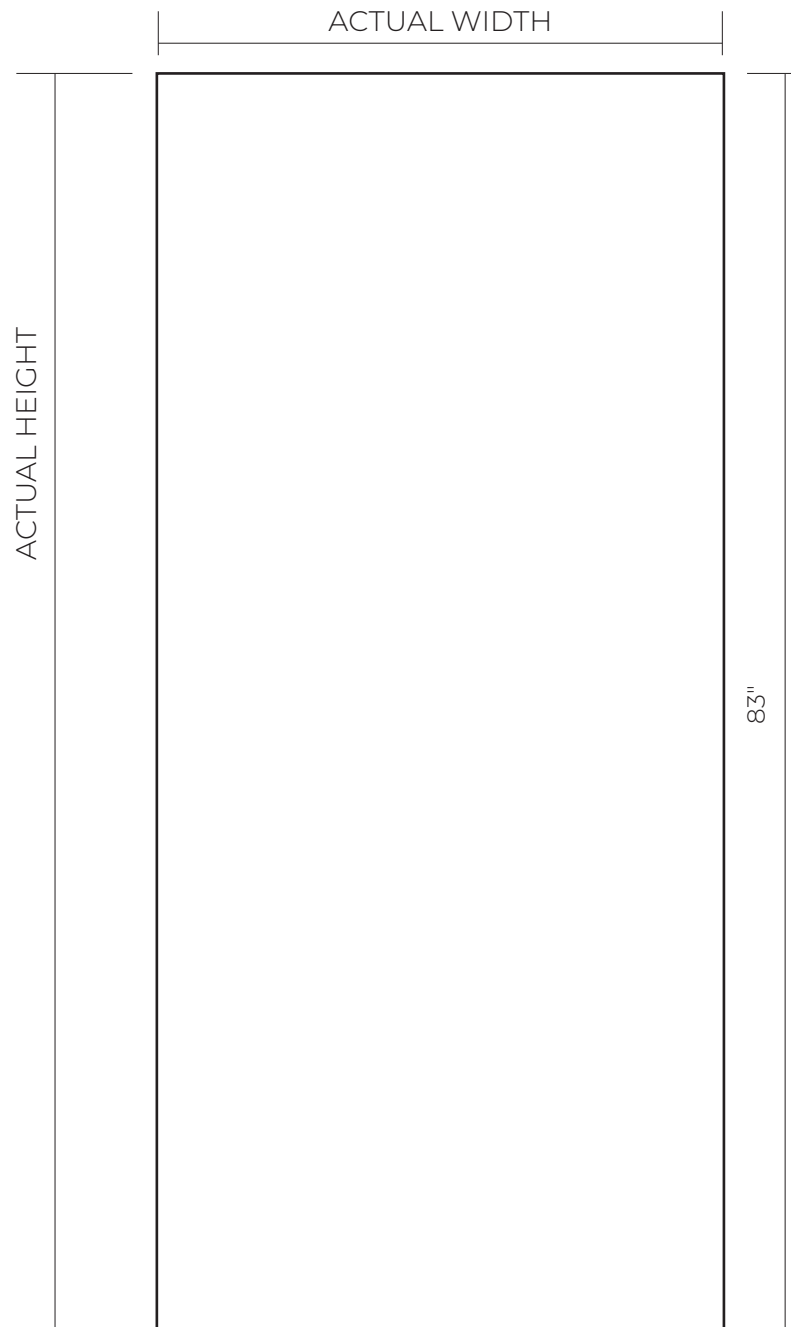

### DOOR WIDTH - WOOD EDGE

| NOMINAL | ACTUAL  |
|---------|---------|
| 2-6     | 29 3/4" |
| 2-8     | 31 3/4" |
| 2-10    | 33 3/4" |
| 3-0     | 35 3/4" |
| 3-6     | 41 3/4" |

### DOOR HEIGHT

| NOMINAL | ACTUAL | CYLINDRICAL PREP |
|---------|--------|------------------|
| 7-0     | 83"    | 49 7/8"          |

### GLASS OPTIONS

| SIZE           | CUTOUT       |
|----------------|--------------|
| 8 x 64         | 9 x 65       |
| 20 x 56 oval** | 21 x 57 oval |
| 22 x 36        | 23 x 37      |
| 22 x 36 RT**   | 23 x 37 RT   |
| 22 x 64        | 23 x 65      |
| 22 x 64 RT**   | 23 x 65 RT   |
| 22 x 17 3L     | 23 x 18      |
| 14 x 64        | 15 x 65      |

GARDEN DOOR SIZES AVAILABLE

\*\*Refer to page 144-145 for non-rectangular cutout dimensions

# 7'0" 6 PANEL

STEEL DOOR

WOOD EDGE | STEEL MARK® & STEEL MARK® PLUS

STEEL MARK® & STEEL MARK® PLUS

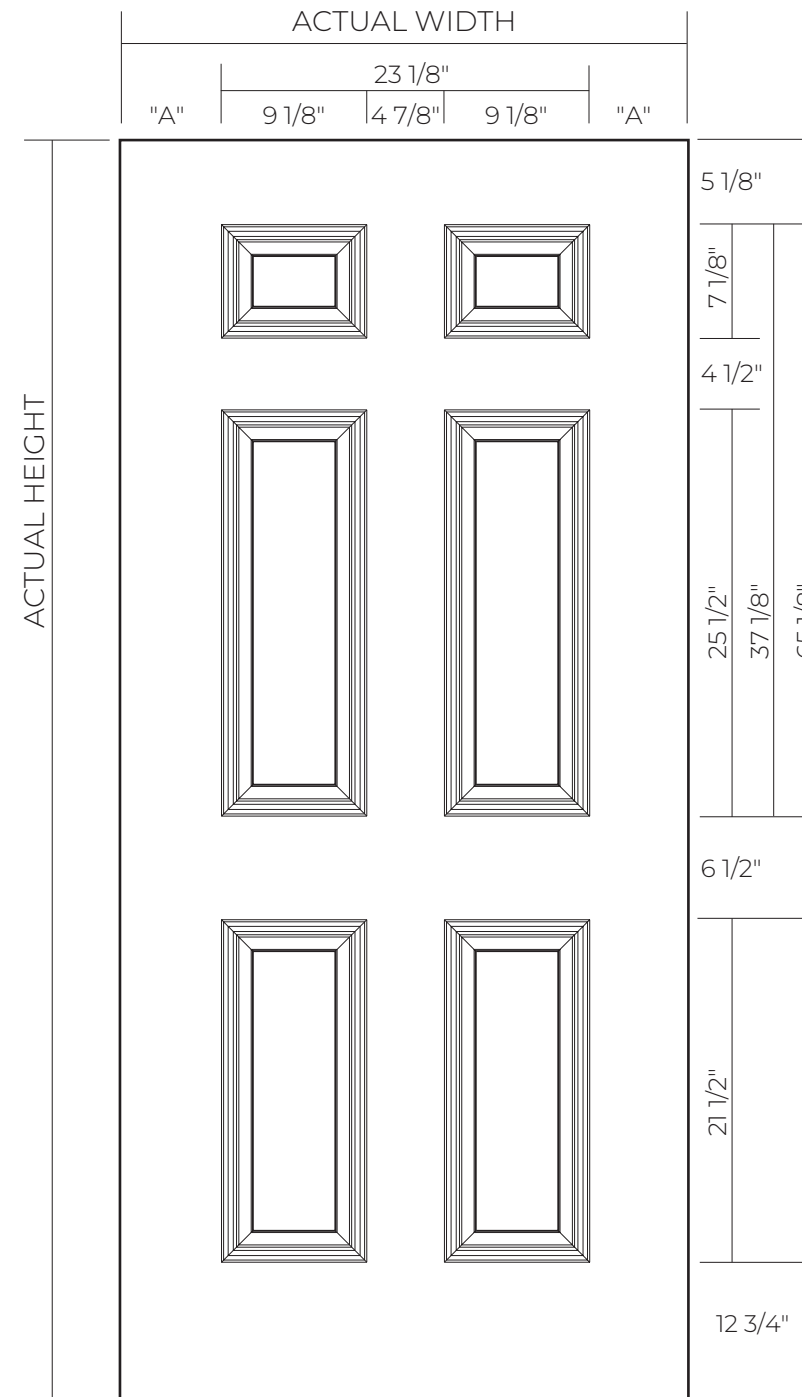

### DOOR WIDTH - WOOD EDGE

| NOMINAL | ACTUAL  | "A"     |
|---------|---------|---------|
| 2-8     | 31 3/4" | 4 5/16" |
| 2-10    | 33 3/4" | 5 5/16" |
| 3-0     | 35 3/4" | 6 5/16" |

### DOOR HEIGHT

| NOMINAL | ACTUAL | CYLINDRICAL PREP |
|---------|--------|------------------|
| 7-0     | 83"    | 49 7/8"          |

### GLASS OPTIONS

| SIZE      | CUTOUT  |
|-----------|---------|
| 8 x 6 2L  | 9 x 7   |
| 8 x 36 2L | 9 x 37  |
| 22 x 36   | 23 x 37 |
| 22 x 64   | 23 x 65 |

# 7'0" 4 PANEL

STEEL DOOR

WOOD EDGE | STEEL MARK® & STEEL MARK® PLUS

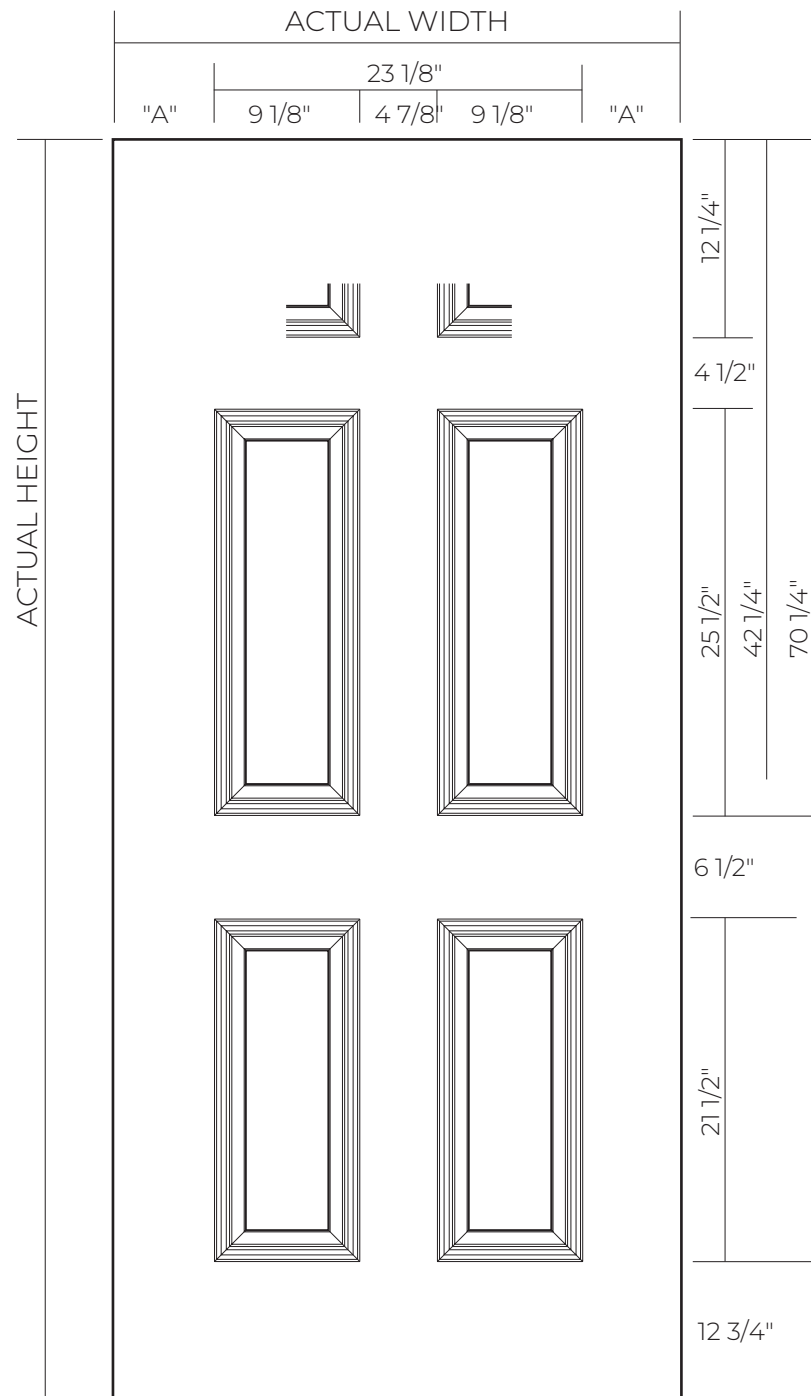

### DOOR WIDTH - WOOD EDGE

| NOMINAL | ACTUAL  | "A"     |
|---------|---------|---------|
| 2-8     | 31 3/4" | 4 5/16" |
| 2-10    | 33 3/4" | 5 5/16" |
| 3-0     | 35 3/4" | 6 5/16" |

### DOOR HEIGHT

| NOMINAL | ACTUAL | CYLINDRICAL PREP |
|---------|--------|------------------|
| 7-0     | 83"    | 49 7/8"          |

### GLASS OPTIONS

| SIZE         | CUTOUT      |
|--------------|-------------|
| 8 x 6 2L     | 9 x 7       |
| 8 x 36 2L    | 9 x 37      |
| 22 x 10 AT** | 23 x 11 AT  |
| 22 x 36      | 23 x 37     |
| 22 x 36 RT** | 23 x 37 RT  |
| 22 x 64      | 23 x 65     |
| 22 x 64 RT** | 23 x 65 RT  |
| 22 x 38 AT** | 23 x 39 AT  |
| 9 x 21 SUN** | 10 x 22 SUN |

\*\*Refer to page 144-145 for non-rectangular cutout dimensions

# 7'0" 2 PANEL 3/4 TOP

STEEL DOOR

WOOD EDGE | STEEL MARK® & STEEL MARK® PLUS

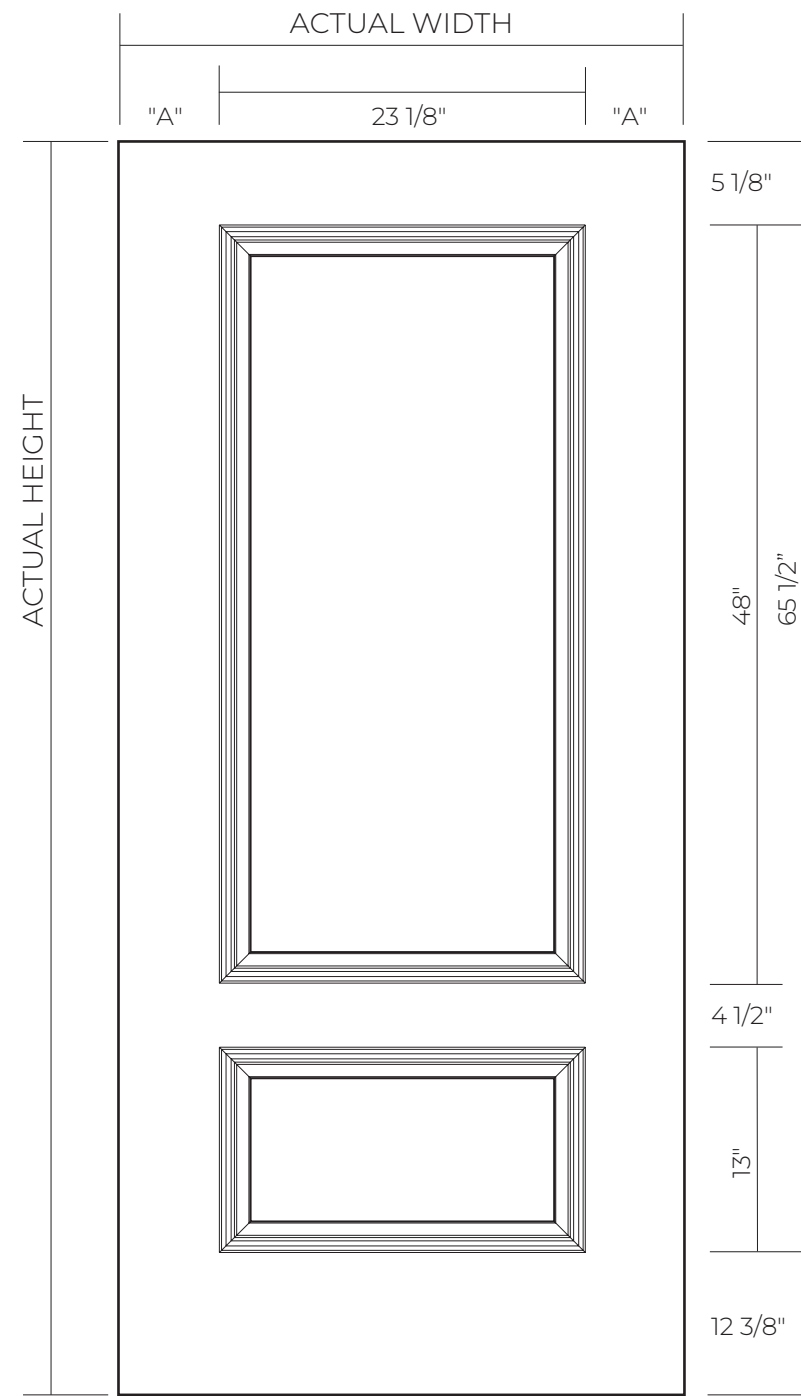

### DOOR WIDTH - WOOD EDGE

| NOMINAL | ACTUAL  | "A"     |
|---------|---------|---------|
| 2-8     | 31 3/4" | 4 5/16" |
| 2-10    | 33 3/4" | 5 5/16" |
| 3-0     | 35 3/4" | 6 5/16" |

### DOOR HEIGHT

| NOMINAL | ACTUAL | CYLINDRICAL PREP |
|---------|--------|------------------|
| 7-0     | 83"    | 49 7/8"          |

### GLASS OPTIONS

| SIZE           | CUTOUT       |
|----------------|--------------|
| 22 x 48        | 23 x 49      |
| 22 x 64        | 23 x 65      |
| 15 x 39 oval** | 16 x 40 oval |

\*\*Refer to page 144-145 for non-rectangular cutout dimensions

STEEL MARK® & STEEL MARK® PLUS

STEEL MARK® & STEEL MARK® PLUS

# 7'0" FLUSH

## STEEL SIDELIGHT

WOOD EDGE | STEEL MARK® & STEEL MARK® PLUS

STEEL MARK® & STEEL MARK® PLUS

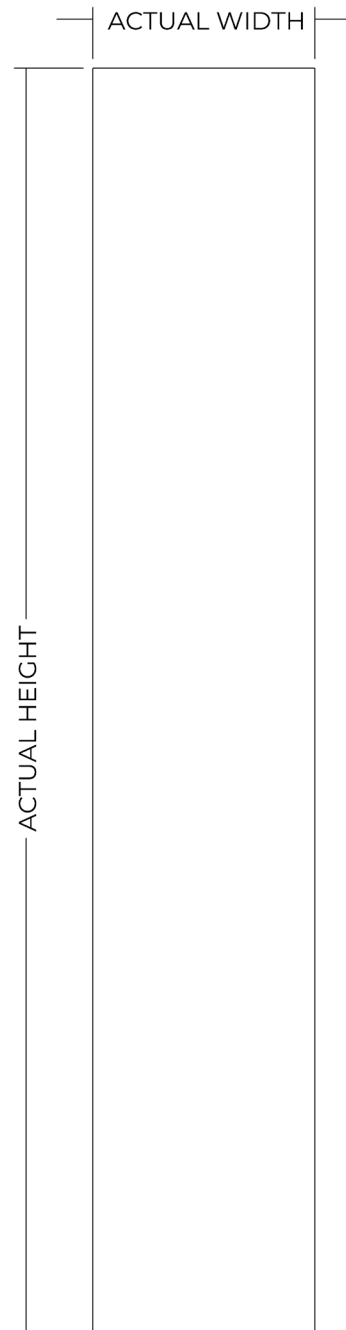

| SIDELIGHT WIDTH - WOOD EDGE |                                  |
|-----------------------------|----------------------------------|
| NOMINAL                     | ACTUAL                           |
| 1-0                         | 11 <sup>7</sup> / <sub>8</sub> " |
| 1-2                         | 13 <sup>7</sup> / <sub>8</sub> " |
| 1-6                         | 17 <sup>7</sup> / <sub>8</sub> " |

| DOOR HEIGHT |        |
|-------------|--------|
| NOMINAL     | ACTUAL |
| 6-8         | 79"    |
| 7-0         | 83"    |

| GLASS OPTIONS |        |
|---------------|--------|
| SIZE          | CUTOUT |
| 7 x 64        | 8 x 65 |
| 8 x 64        | 9 x 65 |

# 8'0" FLUSH

## STEEL DOOR

WOOD EDGE | STEEL MARK® & STEEL MARK® PLUS

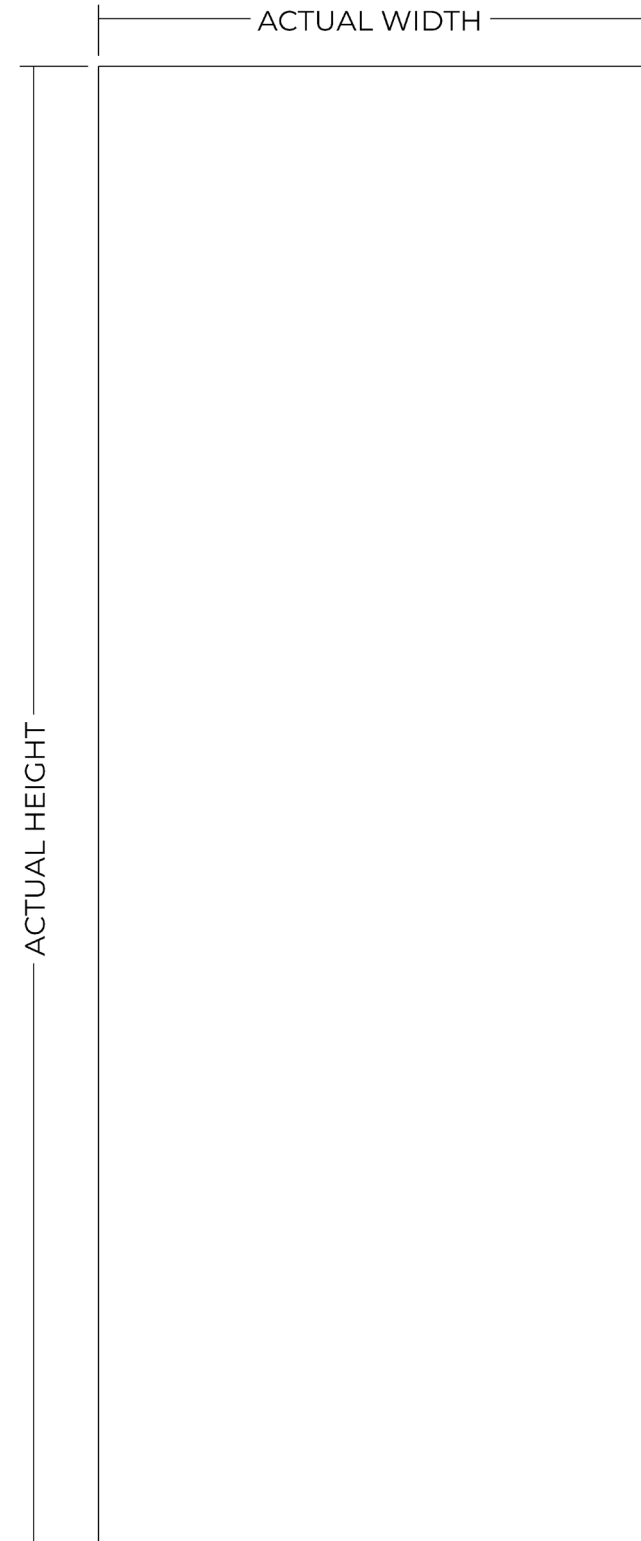

| DOOR WIDTH - WOOD EDGE |         |
|------------------------|---------|
| NOMINAL                | ACTUAL  |
| 2-6                    | 29 3/4" |
| 2-8                    | 31 3/4" |
| 2-10                   | 33 3/4" |
| 3-0                    | 35 3/4" |
| 3-6                    | 41 3/4" |

| DOOR HEIGHT |        |                  |
|-------------|--------|------------------|
| NOMINAL     | ACTUAL | CYLINDRICAL PREP |
| 8-0         | 95"    | 59"              |

| GLASS OPTIONS  |              |
|----------------|--------------|
| SIZE           | CUTOUT       |
| 22 x 80        | 23 x 81      |
| 22 x 36        | 23 x 37      |
| 22 x 64        | 23 x 65      |
| 22 x 17 3L     | 23 x 18      |
| 20 x 56 oval** | 21 x 57 oval |
| 22 x 64 RT**   | 23 x 65 RT   |
| 14 x 80        | 15 x 81      |
| 20 x 80        | 21 x 81      |

STEEL MARK® & STEEL MARK® PLUS

\*\*Refer to page 144-145 for non-rectangular cutout dimensions

# 8'0" 6 PANEL

STEEL DOOR

WOOD EDGE | STEEL MARK® & STEEL MARK® PLUS

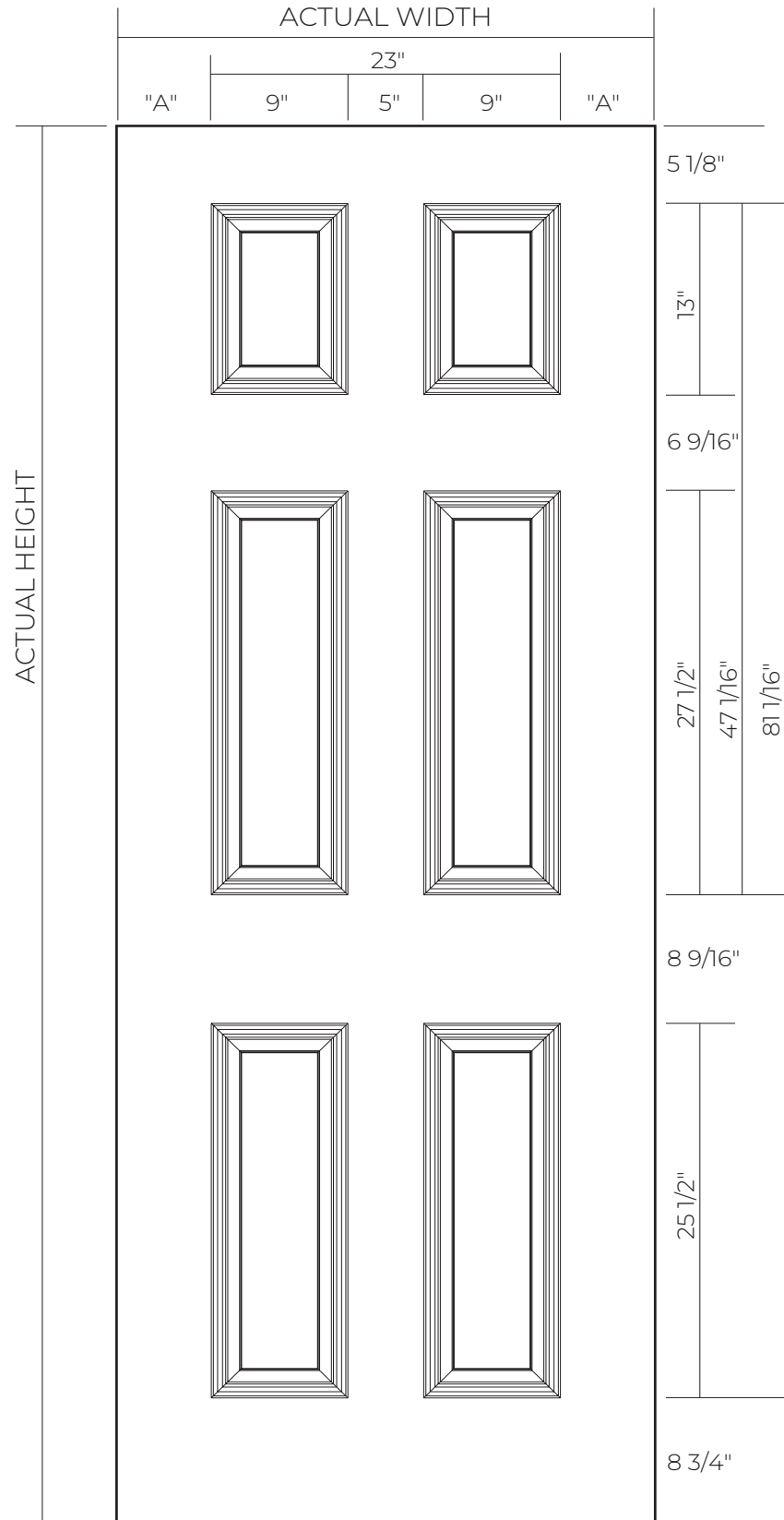

### DOOR WIDTH - WOOD EDGE

| NOMINAL | ACTUAL  | "A"    |
|---------|---------|--------|
| 2-8     | 31 3/4" | 4 3/8" |
| 2-10    | 33 3/4" | 5 3/8" |
| 3-0     | 35 3/4" | 6 3/8" |

### DOOR HEIGHT

| NOMINAL | ACTUAL | CYLINDRICAL PREP |
|---------|--------|------------------|
| 8-0     | 95"    | 59"              |

### GLASS OPTIONS

| SIZE      | CUTOUT  |
|-----------|---------|
| 8 x 48 2L | 9 x 49  |
| 22 x 48   | 23 x 49 |
| 22 x 80   | 23 x 81 |

# 8'0" 2 PANEL SQUARE

STEEL DOOR

WOOD EDGE | STEEL MARK® & STEEL MARK® PLUS

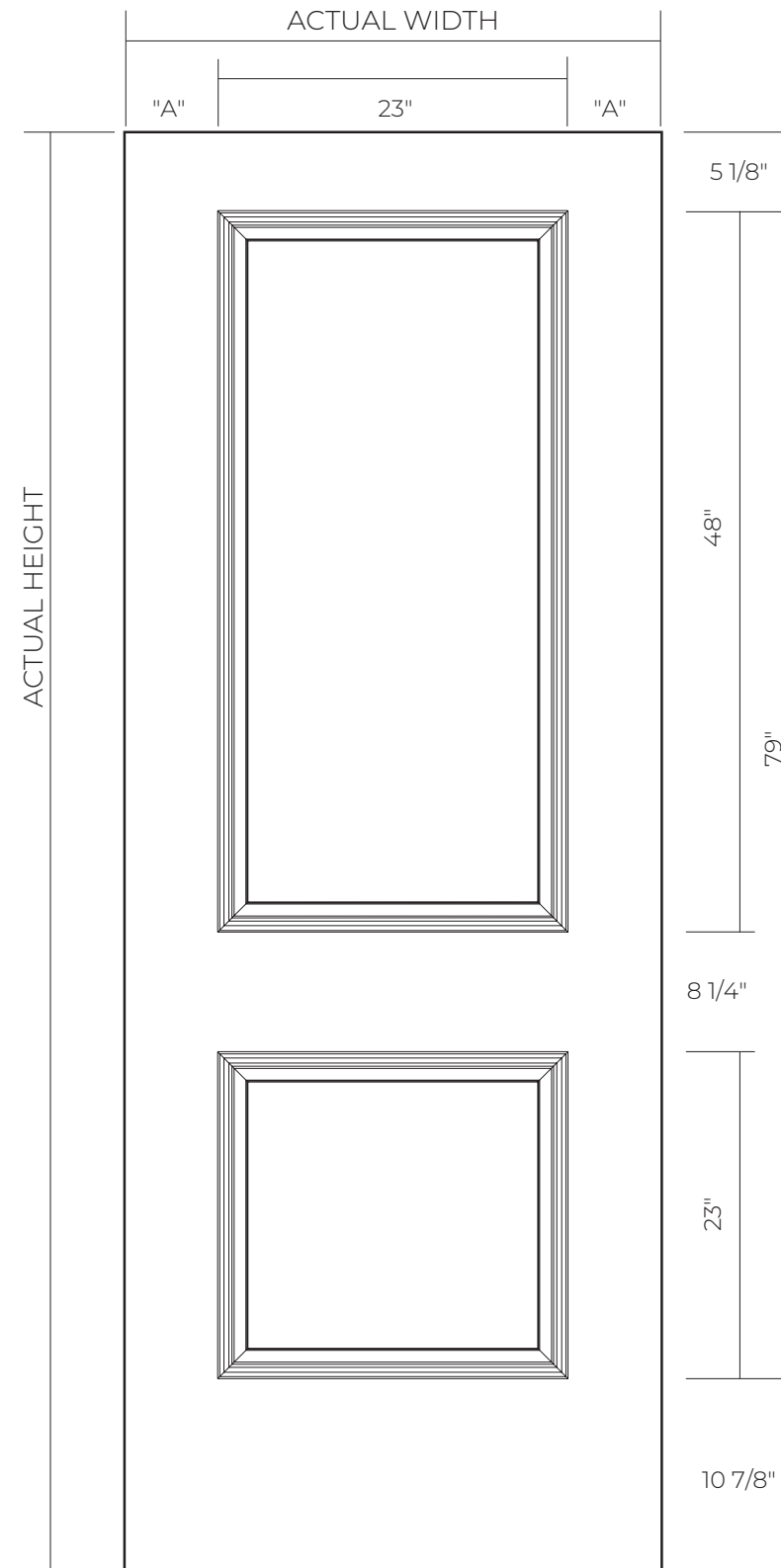

### DOOR WIDTH - WOOD EDGE

| NOMINAL | ACTUAL  | "A"    |
|---------|---------|--------|
| 2-8     | 31 3/4" | 4 3/8" |
| 2-10    | 33 3/4" | 5 3/8" |
| 3-0     | 35 3/4" | 6 3/8" |

### DOOR HEIGHT

| NOMINAL | ACTUAL | CYLINDRICAL PREP |
|---------|--------|------------------|
| 8-0     | 95"    | 59"              |

### GLASS OPTIONS

| SIZE    | CUTOUT  |
|---------|---------|
| 22 x 48 | 23 x 49 |
| 22 x 80 | 23 x 81 |

STEEL MARK® & STEEL MARK® PLUS

STEEL MARK® & STEEL MARK® PLUS

# 8'0" EUROLINE 8

STEEL DOOR

WOOD EDGE | STEEL MARK® & STEEL MARK® PLUS

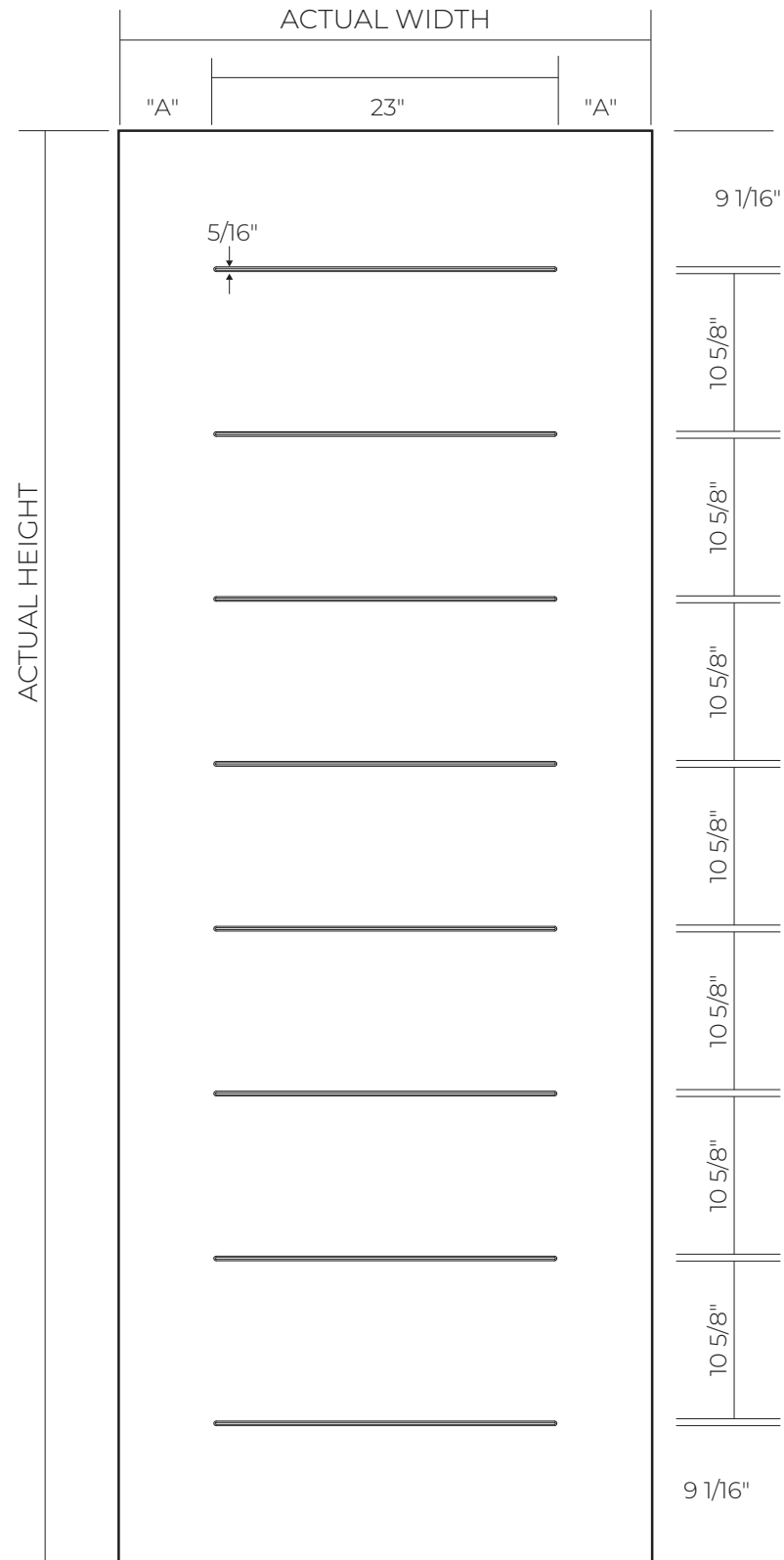

### DOOR WIDTH - WOOD EDGE

| NOMINAL | ACTUAL  | "A"    |
|---------|---------|--------|
| 2-8     | 31 3/4" | 4 3/8" |
| 2-10    | 33 3/4" | 5 3/8" |
| 3-0     | 35 3/4" | 6 3/8" |

### DOOR HEIGHT

| NOMINAL | ACTUAL | CYLINDRICAL PREP |
|---------|--------|------------------|
| 8-0     | 95"    | 59"              |

# 8'0" 2 PANEL w/23x65 CUTOUT

STEEL DOOR

WOOD EDGE | STEEL MARK® & STEEL MARK® PLUS

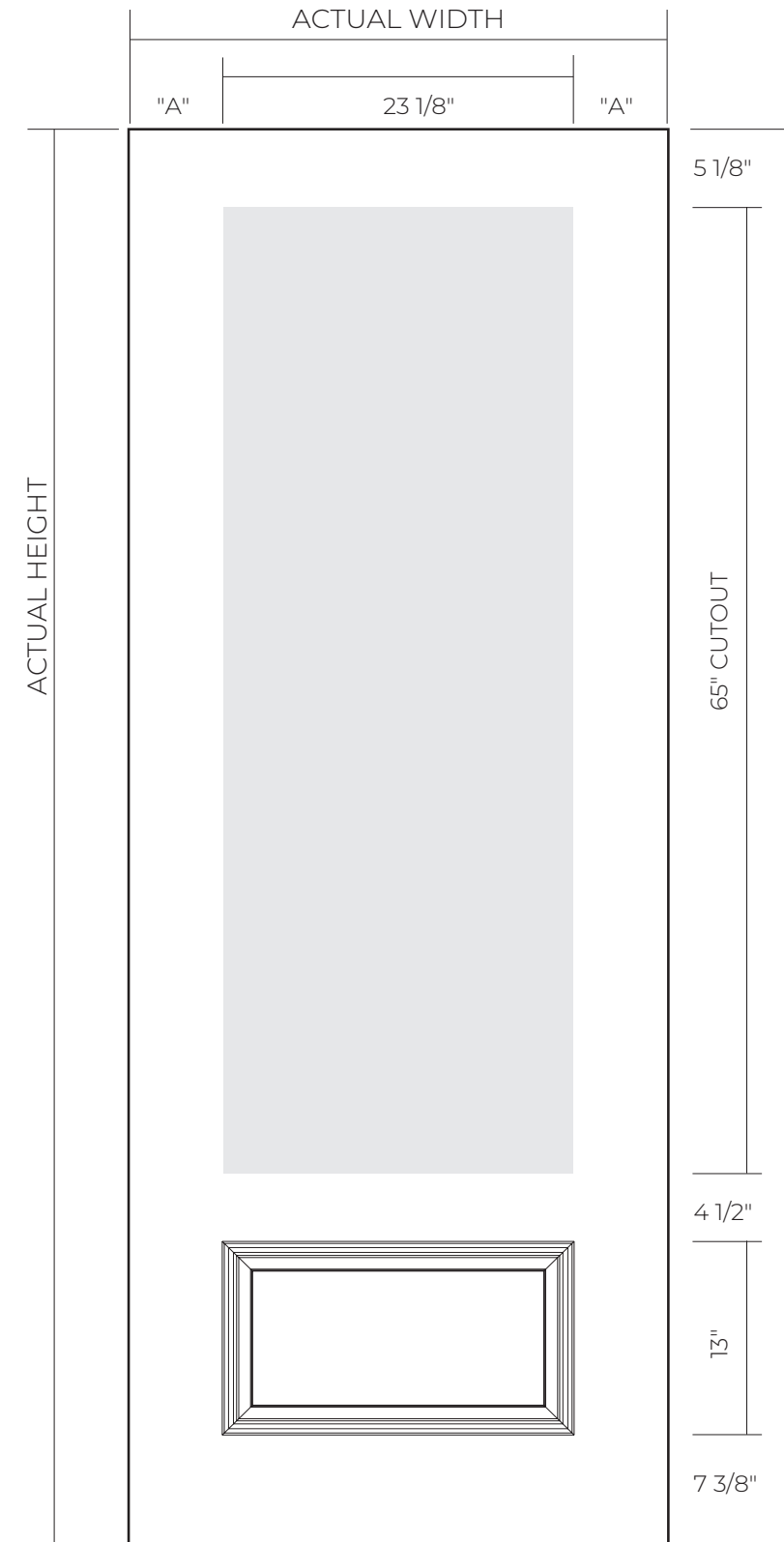

### DOOR WIDTH - WOOD EDGE

| NOMINAL | ACTUAL  | "A"     |
|---------|---------|---------|
| 2-8     | 31 3/4" | 4 5/16" |
| 2-10    | 33 3/4" | 5 5/16" |
| 3-0     | 35 3/4" | 6 5/16" |

### DOOR HEIGHT

| NOMINAL | ACTUAL | CYLINDRICAL PREP |
|---------|--------|------------------|
| 8-0     | 95"    | 59"              |

### GLASS OPTIONS

| SIZE    | CUTOUT  |
|---------|---------|
| 22 x 64 | 23 x 65 |

STEEL MARK® & STEEL MARK® PLUS

STEEL MARK® & STEEL MARK® PLUS

# 8'0" FLUSH

## STEEL SIDELIGHT

WOOD EDGE | STEEL MARK® & STEEL MARK® PLUS

STEEL MARK® & STEEL MARK® PLUS

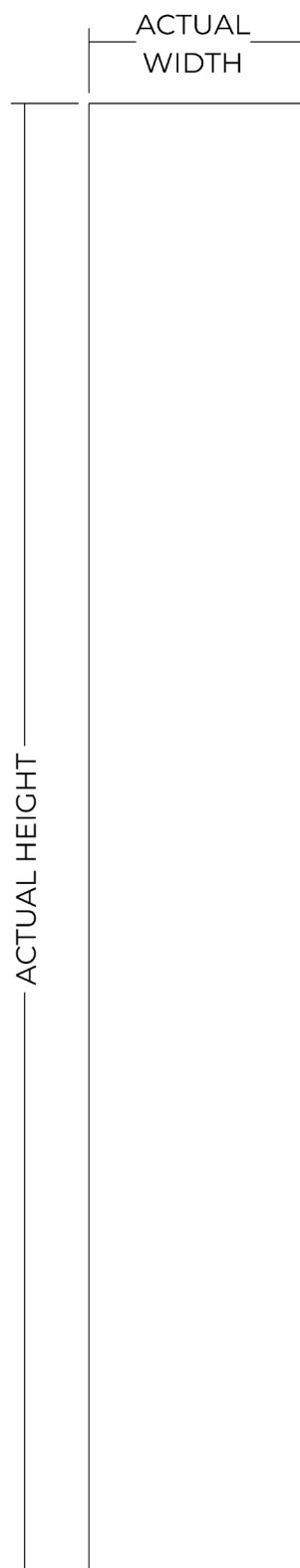

| SIDELIGHT WIDTH |         |
|-----------------|---------|
| NOMINAL         | ACTUAL  |
| 1-0             | 11 7/8" |
| 1-2             | 13 7/8" |
| 1-6             | 17 7/8" |

| SIDELIGHT HEIGHT |        |
|------------------|--------|
| NOMINAL          | ACTUAL |
| 8-0              | 95"    |

| GLASS OPTIONS |        |
|---------------|--------|
| SIZE          | CUTOUT |
| 8 x 80        | 9 x 81 |

# STEEL PRO®

## WOOD-EDGE DOORS AND SIDELIGHTS



# 6'8" FLUSH

STEEL DOOR

WOOD EDGE | STEEL PRO®

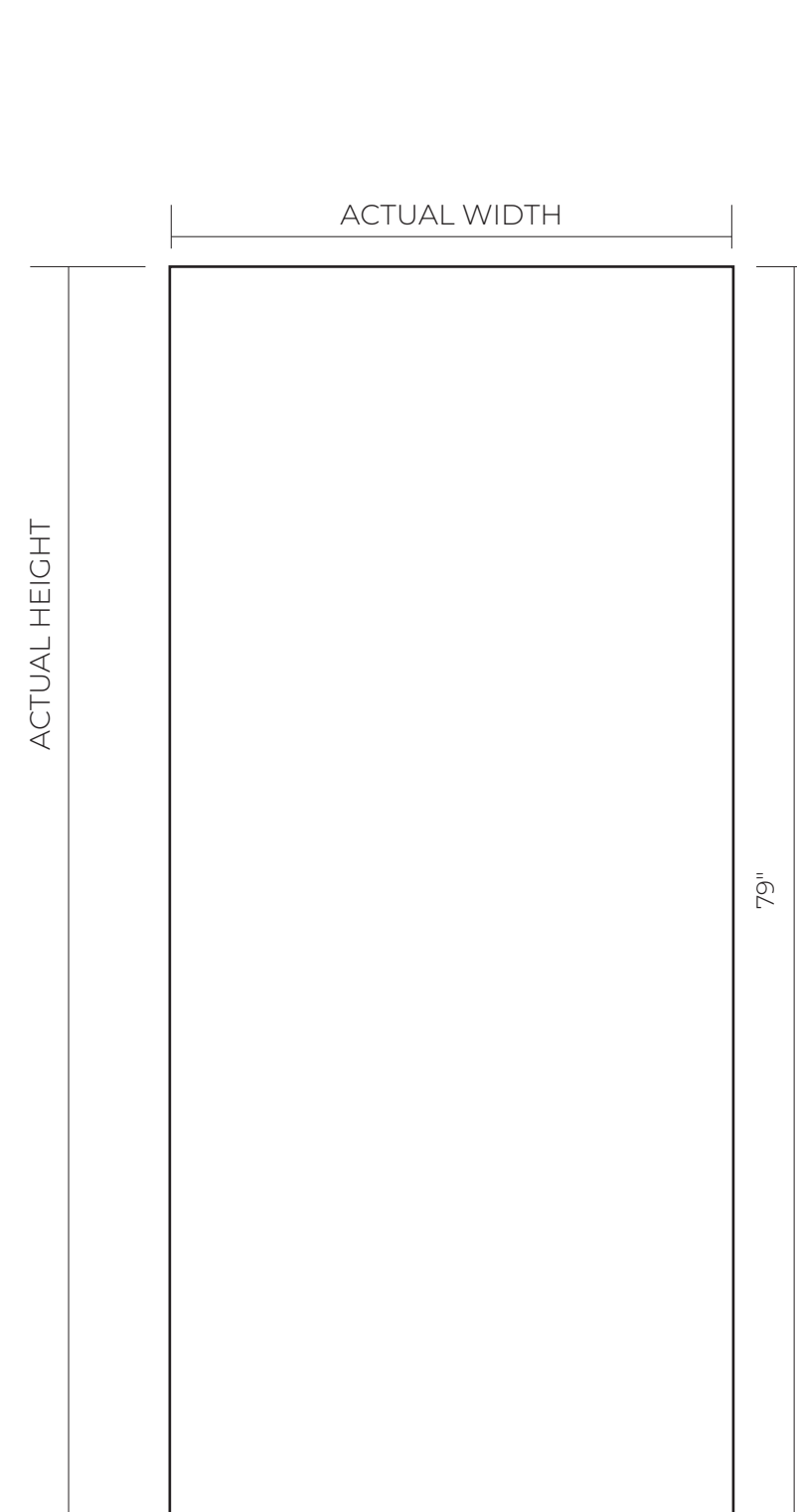

### DOOR WIDTH - WOOD EDGE

| NOMINAL | ACTUAL  |
|---------|---------|
| 2-6     | 29 3/4" |
| 2-8     | 31 3/4" |
| 2-10    | 33 3/4" |
| 3-0     | 35 3/4" |

### DOOR HEIGHT

| NOMINAL | ACTUAL | CYLINDRICAL PREP |
|---------|--------|------------------|
| 6-8     | 79"    | 45 7/8"          |

### GLASS OPTIONS

| SIZE           | CUTOUT       |
|----------------|--------------|
| 7 x 64         | 8 x 65       |
| 11 x 5 3L      | 12 x 6 3L    |
| 12 x 12 3L     | 13 x 13 3L   |
| 22 x 3.5 5L    | 23 x 4.5 5L  |
| 22 x 10 3L     | 23 x 11 3L   |
| 22 x 36        | 23 x 37      |
| 22 x 64        | 23 x 65      |
| 22 x 64 RT**   | 23 x 65 RT   |
| 20 x 56 oval** | 21 x 57 oval |

GARDEN DOOR SIZES AVAILABLE

\*\*Refer to page 144-145 for non-rectangular cutout dimensions

# 6'8" 6 PANEL

STEEL DOOR

WOOD EDGE | STEEL PRO®

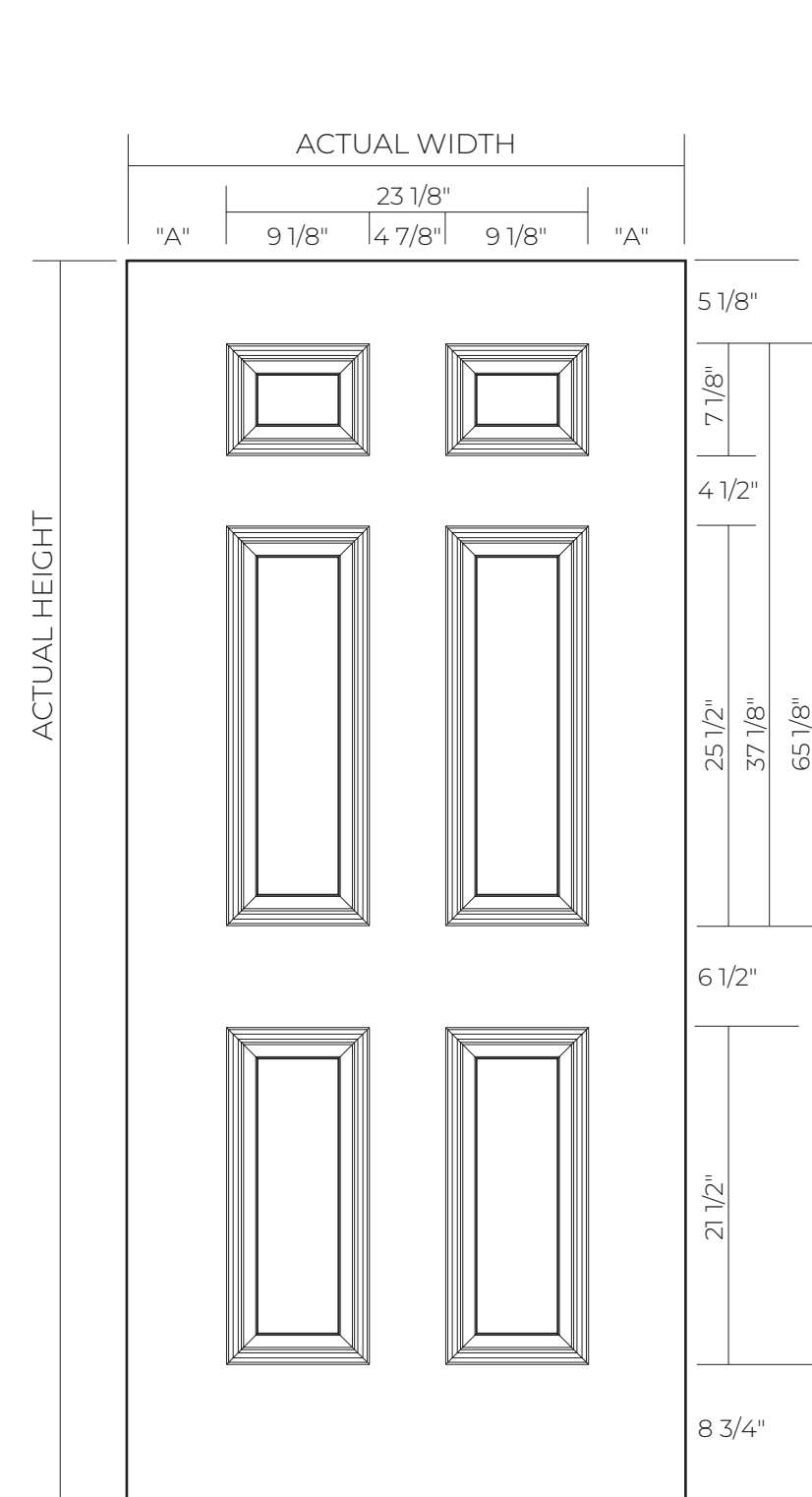

### DOOR WIDTH - WOOD EDGE

| NOMINAL | ACTUAL  | "A"     |
|---------|---------|---------|
| 2-8     | 31 3/4" | 4 5/16" |
| 2-10    | 33 3/4" | 5 5/16" |
| 3-0     | 35 3/4" | 6 5/16" |

### DOOR HEIGHT

| NOMINAL | ACTUAL | CYLINDRICAL PREP |
|---------|--------|------------------|
| 6-8     | 79"    | 45 7/8"          |

### GLASS OPTIONS

| SIZE      | CUTOUT  |
|-----------|---------|
| 8 x 6 2L  | 9 x 7   |
| 8 x 36 2L | 9 x 37  |
| 22 x 36   | 23 x 37 |
| 22 x 64   | 23 x 65 |

# 6'8" 4 PANEL

STEEL DOOR

WOOD EDGE | STEEL PRO®

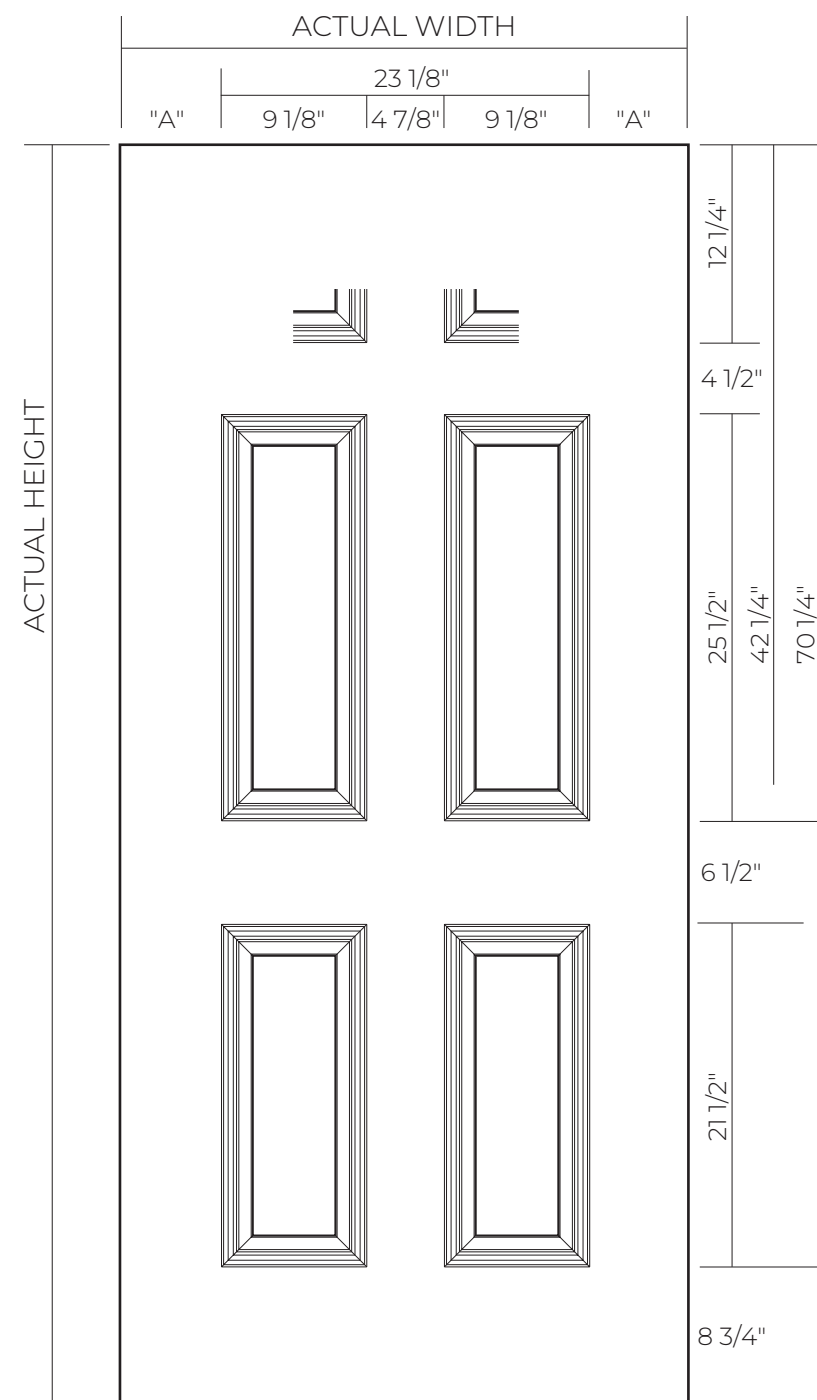

### DOOR WIDTH - WOOD EDGE

| NOMINAL | ACTUAL  | "A"     |
|---------|---------|---------|
| 2-8     | 31 3/4" | 4 5/16" |
| 2-10    | 33 3/4" | 5 5/16" |
| 3-0     | 35 3/4" | 6 5/16" |

### DOOR HEIGHT

| NOMINAL | ACTUAL | CYLINDRICAL PREP |
|---------|--------|------------------|
| 6-8     | 79"    | 45 7/8"          |

### GLASS OPTIONS

| SIZE         | CUTOUT      |
|--------------|-------------|
| 8 x 6 2L     | 9 x 7       |
| 8 x 36 2L    | 9 x 37      |
| 22 x 10 AT** | 23 x 11 AT  |
| 22 x 36      | 23 x 37     |
| 22 x 38 AT** | 23 x 39 AT  |
| 22 x 36 RT** | 23 x 37 RT  |
| 22 x 64      | 23 x 65     |
| 22 x 64 RT** | 23 x 65 RT  |
| 9 x 21 SUN** | 10 x 22 SUN |

\*\*Refer to page 144-145 for non-rectangular cutout dimensions

# ADDITIONAL RESOURCES

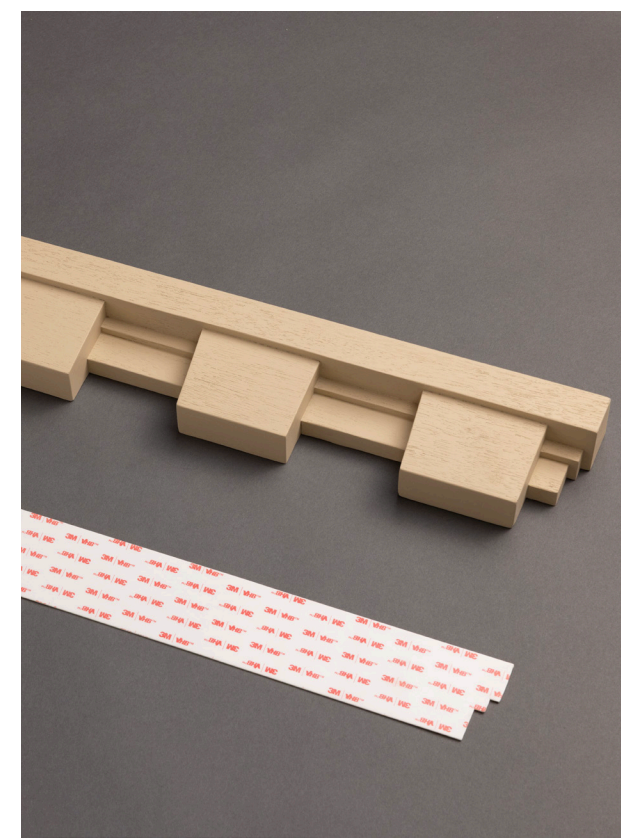

STEEL PRO®



# SHAPED DOORGLASS CUTOUT DIMENSIONS

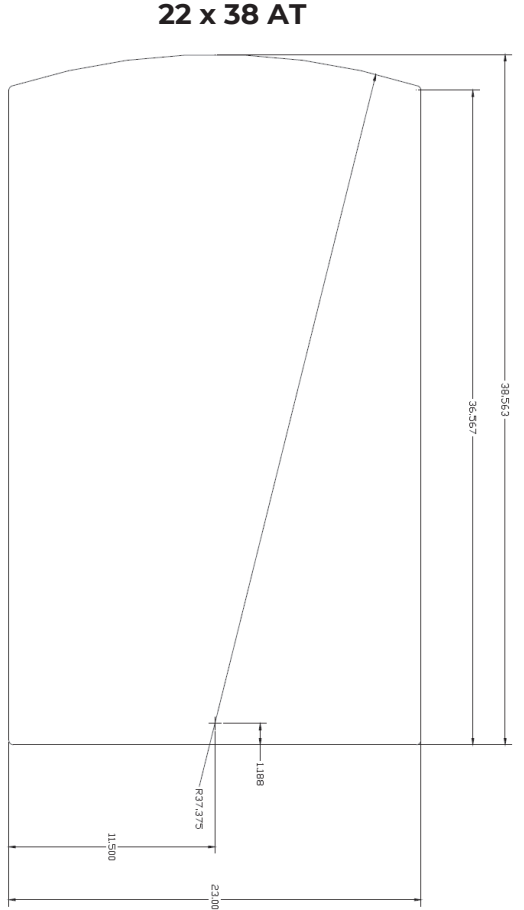
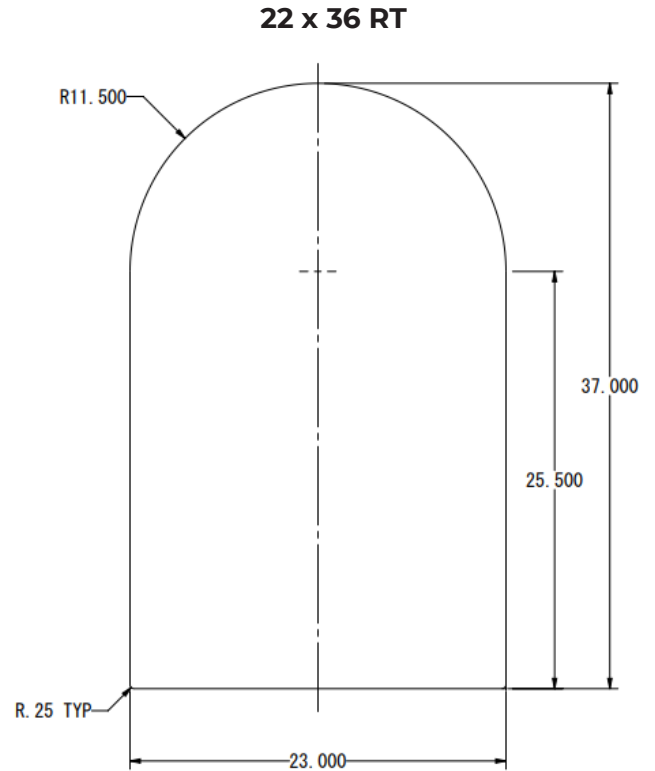
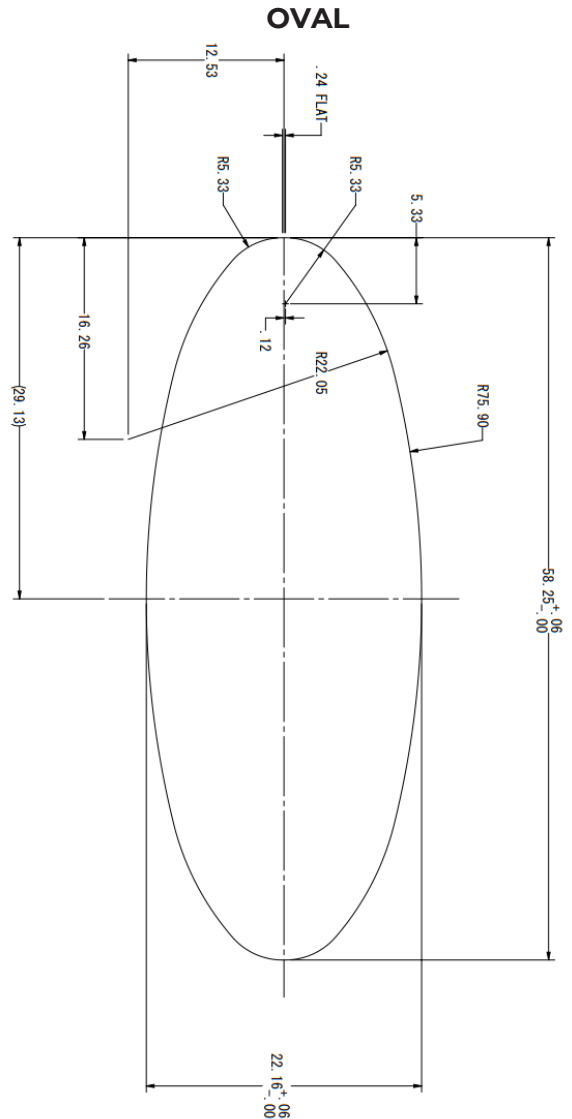
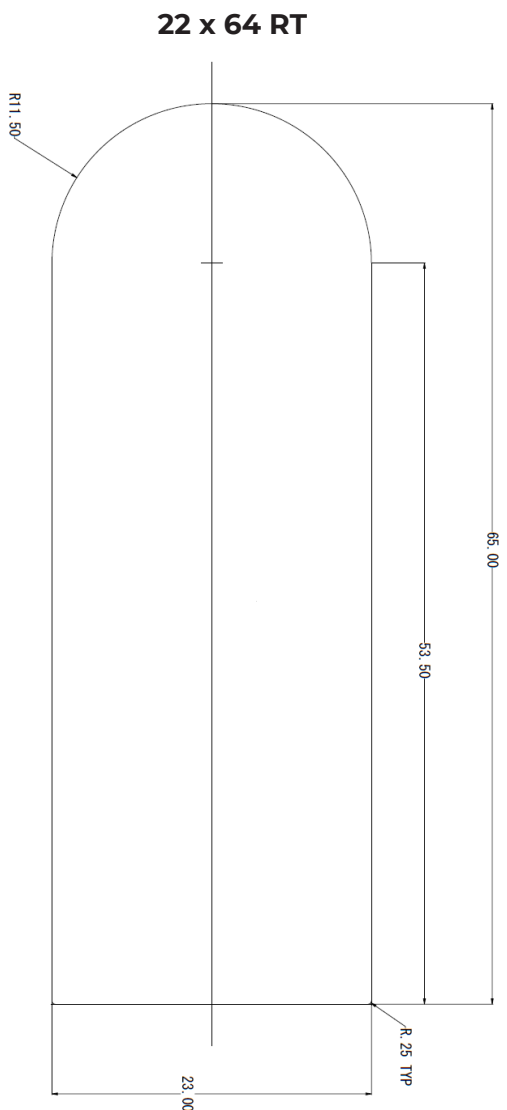
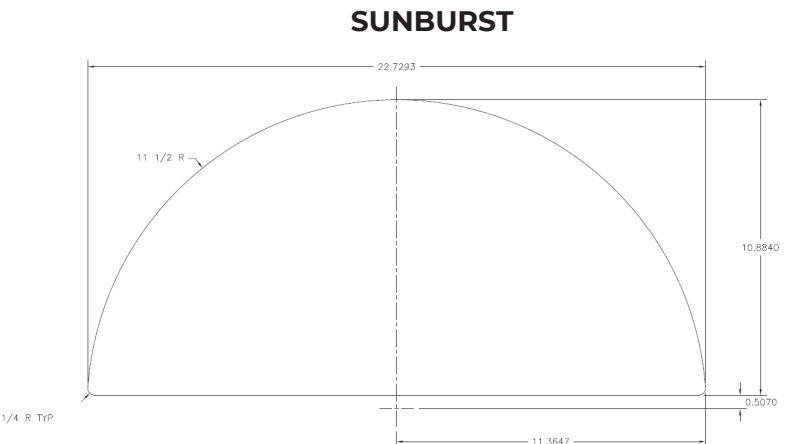
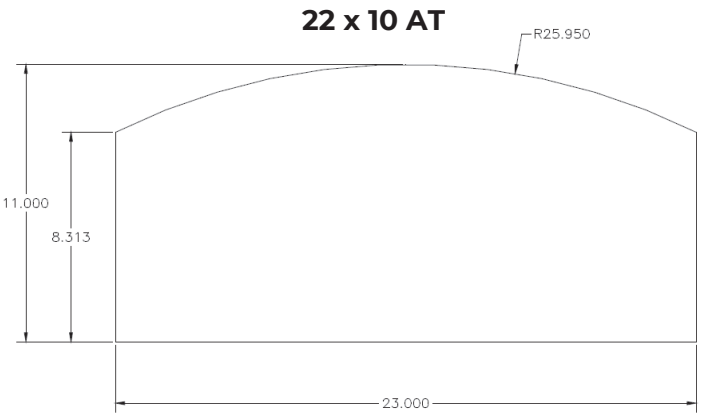

# FIRE RATED OPTIONS

## FIBERGLASS DOORS

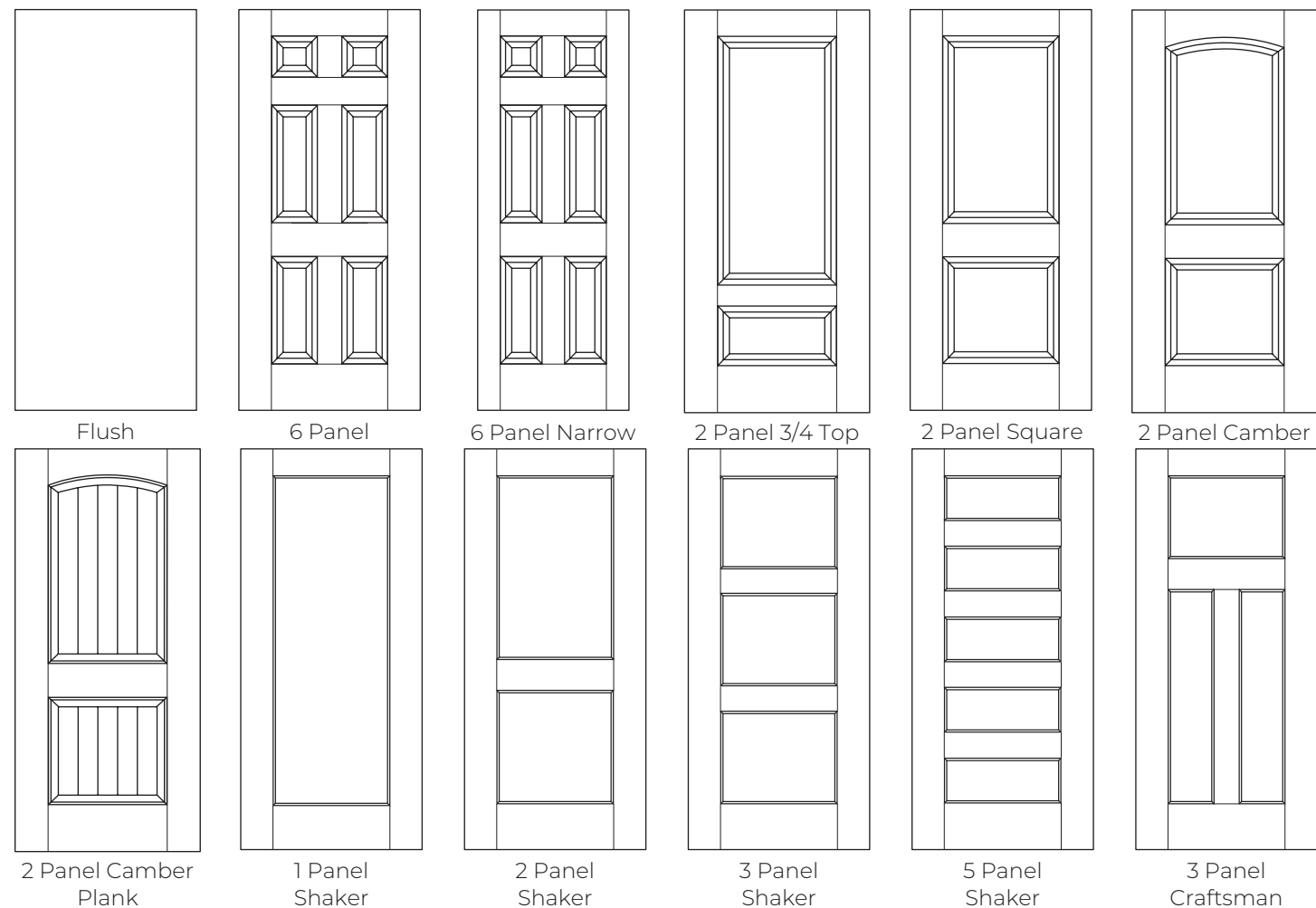

**PRODUCT:**

ODL Fiberglass Satin Smooth Texture Fire Rated Door.

**FIRE CLASS AND FEATURED STANDARDS:**

20 minute Fire Rated Category B door; UL 10C; UL 10B; NFPA 252 (US).

**FIRE RESISTANCE AND APPLICATION:**

20 minute Positive Pressure without Hose Stream.

Must be installed in accordance with NFPA 80.

Category "B" Door requires a listed category "C" gasket in positive pressure applications.

Smoke and Draft door rating requires a listed category "H" gasket.

**PRODUCT DESCRIPTION:**

Fiberglass face, fire-resistant PU foam core door.

4" LSL stiles with maple wood caps.

Flush and embossed door designs.

20 minute mylar fire label applied or custom label for authorized customers.

**SIZES:**

Max size opening: 3'0" wide x 6'8" high, door thickness: 1 3/4".

**LIMITATIONS:**

Single units only. Approved for cylindrical latch and dead bolt—maximum 2 3/4" backset.

Permitted surface mounted listed and labeled hardware.

# FIRE RATED OPTIONS

## WOOD-EDGE & STEEL-EDGE STEEL DOORS

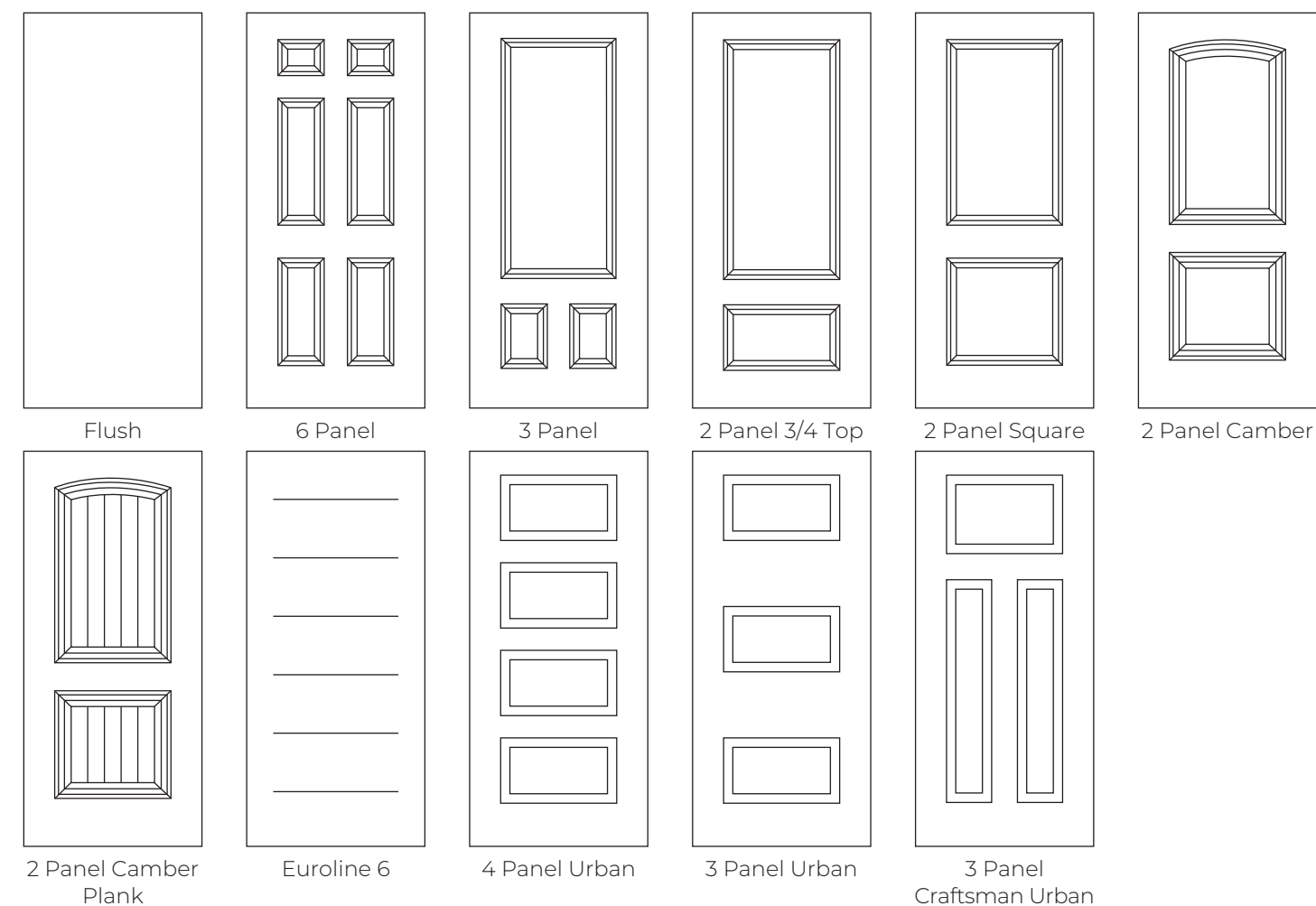

**PRODUCT:**

ODL Steel Mark® and Steel Mark® Plus Wood Edge and Steel Edge options with PU Foam Core.

**FIRE CLASS AND FEATURED STANDARDS:**

20 minute Fire Rated Category B door; UL 10C; UL 10B; NFPA 252 (US).

**FIRE RESISTANCE AND APPLICATION:**

Wood Edge: 20 minute Positive Pressure with Hose Stream.

Steel Edge: 20 minute Positive Pressure without Hose Stream.

Must be installed in accordance with NFPA 80.

Category "B" Door requires a listed category "C" gasket in positive pressure applications.

Smoke and Draft door rating requires a listed category "H" gasket.

**PRODUCT DESCRIPTION:**

Steel skin 24ga wood edge door with PU foam core.

Flush and embossed door designs.

20 minute metal fire label applied or custom label for authorized customers.

**SIZES:**

Max size opening: 3'0" wide x 6'8" high, door thickness: 1 3/4".

**LIMITATIONS:**

Single units only. Approved for cylindrical latch and dead bolt—maximum 2 3/4" backset.

Permitted surface mounted listed and labeled hardware.

# ADA OPTIONS

AMERICANS WITH DISABILITIES ACT  
COMPLIANT FIBERGLASS DOORS

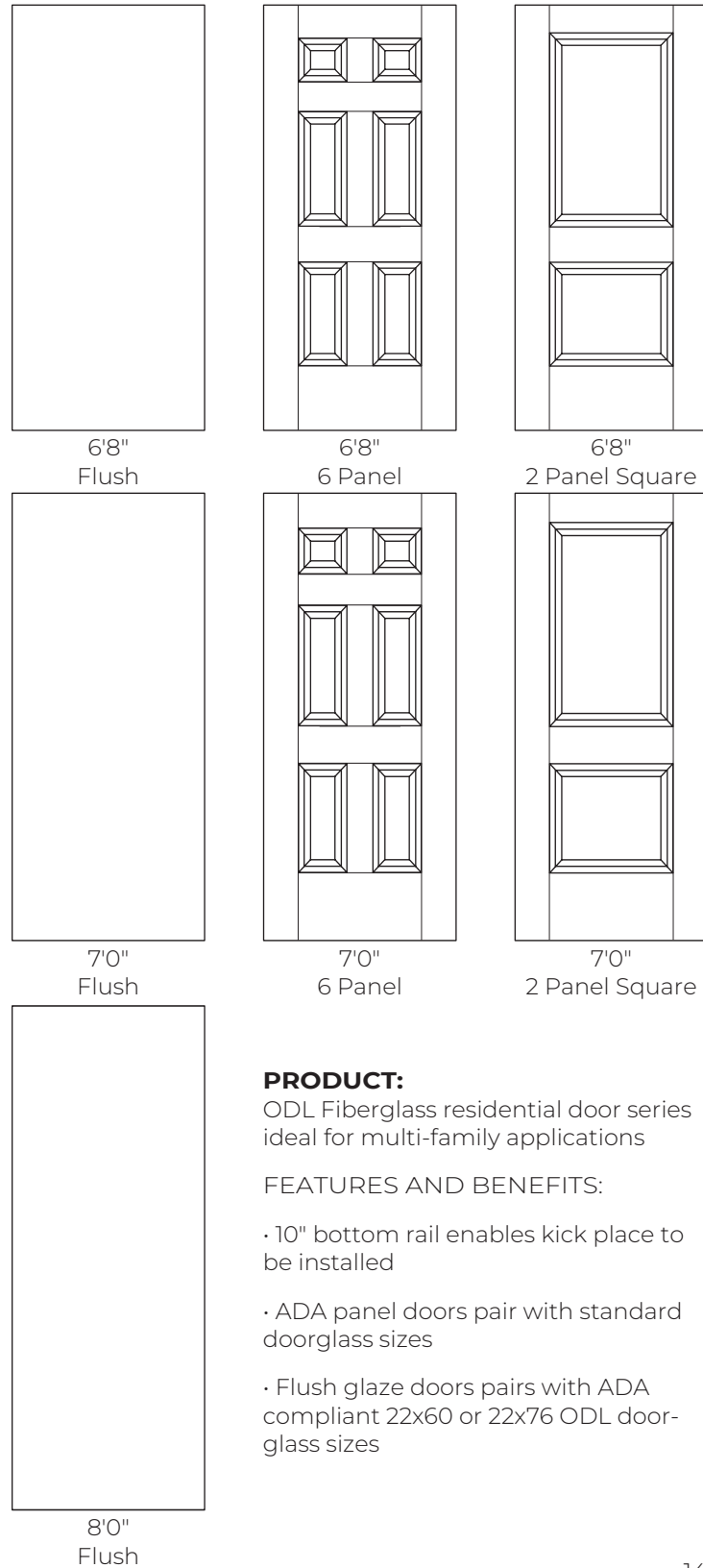

**PRODUCT:**

ODL Fiberglass residential door series ideal for multi-family applications

**FEATURES AND BENEFITS:**

- 10" bottom rail enables kick plate to be installed
- ADA panel doors pair with standard doorglass sizes
- Flush glaze doors pairs with ADA compliant 22x60 or 22x76 ODL door-glass sizes



# SDL KITS

FIBERGLASS DOOR ACCESSORIES

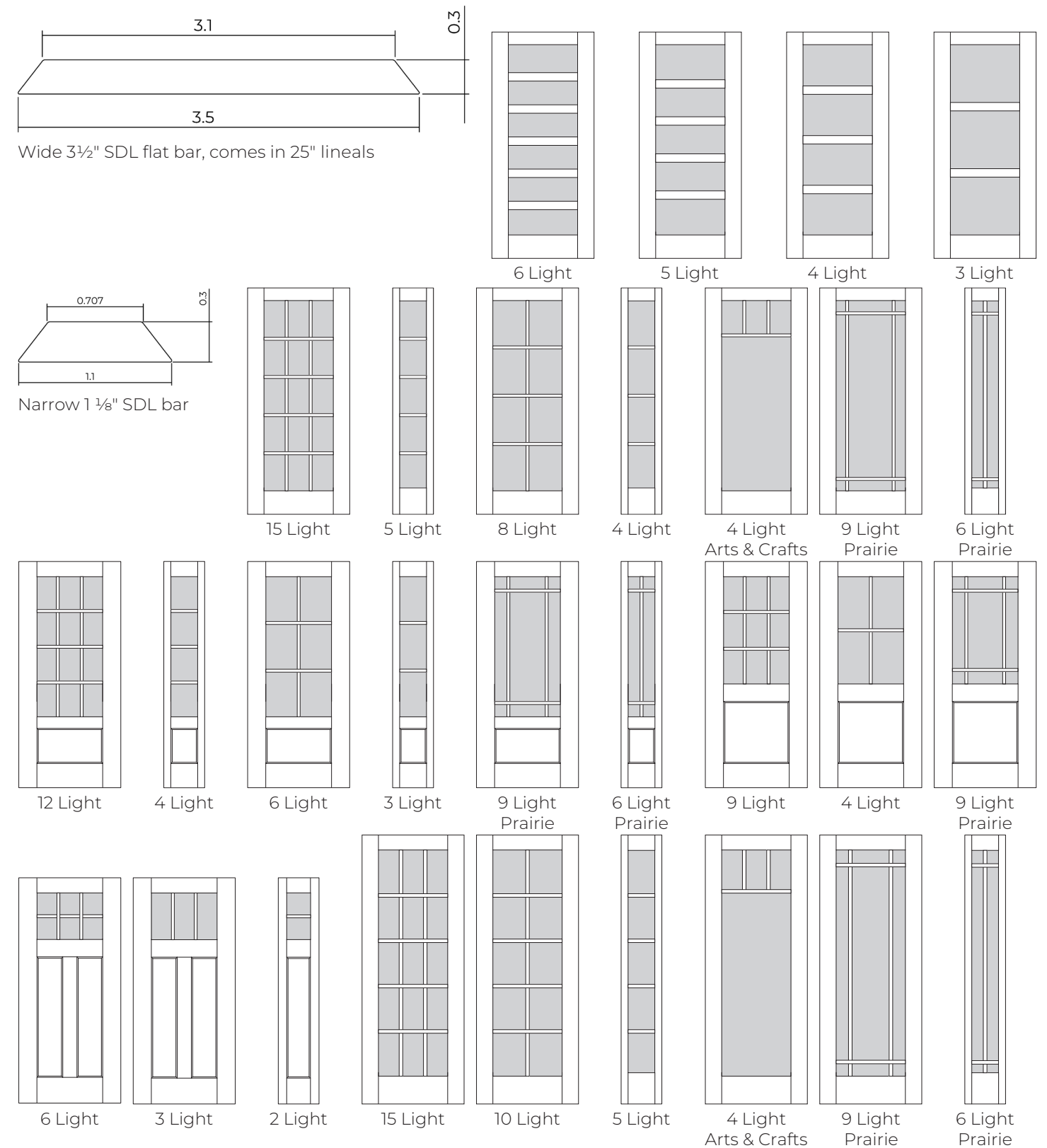

# DENTIL SHELVES

## FIBERGLASS DOOR ACCESSORIES



4 Block Dentil Shelf  
23 1/2" x 3 1/2"

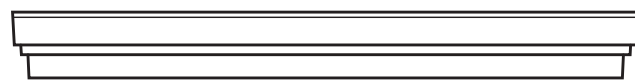

2 Tier Dentil Shelf  
23 3/4" x 2 1/2"

### DENTIL SHELF INSTALLATION

#### FIBERGLASS AND HD STEEL CRAFTSMAN DOORS

STEP 1. Lay the door on a clean, flat surface with the exterior of the door facing up.

Clean the door to remove all dirt and debris using a mild soap and water solution. Thoroughly rinse the door with clean water to remove any soap residue. Door must be completely dry prior to dentil shelf installation.

STEP 2. Before applying the adhesive tape, place the dentil shelf at the desired location on the door panel. The shelf should be centered on the width of the door and parallel to the glass opening. The shelf should also be centered between the glass opening (flush glazed doors), or doorglass frame and the vertical embossments on the panel. Once located, lightly mark the position on the door with a graphite pencil along the top and sides of the shelf.  
See Fig. 1.

STEP 3. Lightly sand ONLY the backside of the dentil shelf where the adhesive strip will be applied. Ensure the surface is dry and free of all dust, dirt, and debris. Without removing the adhesive liner place the adhesive strip against the shelf to determine correct fit. Any protruding portions of the adhesive strip should be trimmed prior to installation.

STEP 4. Remove the protective liner on one side only of the adhesive strip and carefully align the adhesive strip with the dentil shelf. Ensure good contact of the adhesive strip and the dentil shelf by applying pressure.

STEP 5. Remove the other side of the protective liner and using the pencil marks, locate the shelf on the door panel. Apply firm pressure to the dentil shelf to ensure proper adhesion.  
See Fig. 2.

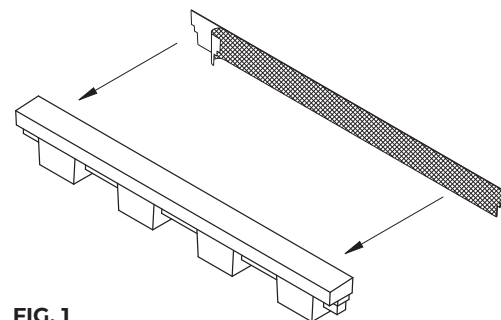

FIG. 1

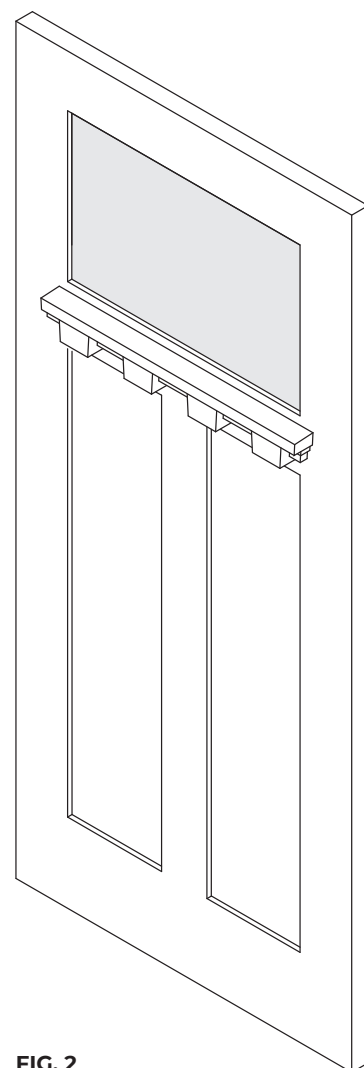

FIG. 2

# CLEANING & FINISHING INSTRUCTIONS



Scan to see details or visit  
[www.odl.com/owners-information](http://www.odl.com/owners-information)

### TIMING

Time allotted to finish door in order to comply with warranty:

- 4 weeks from installation date on Steel.
- 6 months from installation date on Fiberglass.

### DOOR PREP

Door may be finished while hanging in the door frame or removed from the jamb (ODL recommends finishing the door out of the frame on a flat, horizontal surface). If finished in the door frame, remove all hardware including weatherstrip. Weatherstrip may be removed by gently pulling it out. Reinsert by pushing back in once the door has completely dried.

- To remove door from the frame, use hammer and center punch to remove door pins from the hinges.
- For outswing doors the hinge leaf must be removed.
- We recommend finishing doors:
  - In a horizontal position on a padded surface.
  - Out of direct sunlight.
  - In a dust-free environment.
- Allow doors to acclimate to local conditions for at least 24 hours.
- Clean all Steel door surfaces with lint free rag, mild detergent and water or TSP (Tri-sodium phosphate solution) and allow to fully dry.
- Clean all Fiberglass door surfaces with lint free rag and denatured alcohol then allow to fully dry.
- If the door contains glass insert and exhibits excess sealant or squeeze out, follow the guidelines below:
  - Spray the area with standard glass cleaner.
  - Carefully score the the excess sealant with a utility knife at a 45 degree angle
  - Use caution not to scratch the glass.
- Never use sand paper or lacquer thinner on Fiberglass doors.

### MATERIALS NEEDED

The following list of materials is a general list required for finishing doors properly. Not all materials and tools may be required based on the finishing project.

#### Painting:

- Safety Glasses & Rubber/Latex Gloves
- Dust Mask/Respirator Suitable for Painting
- 2 Stir Sticks
- Screwdriver
- Hammer
- Punch
- Utility Knife
- Paintbrush/Roller
- Sprayer
- Denatured Alcohol
- Masking Tape
- Sandpaper (400 grit) or Fine Steel Wool (#0000)
- Clean Lint Free Cloth
- Paint Thinner or Mineral Spirits (Clean-Up)

#### Staining:

- Safety Glasses & Rubber/Latex Gloves
- Dust Mask/Respirator Suitable for Painting
- 2 Stir Sticks
- Screwdriver
- Hammer
- Punch
- Utility Knife
- Synthetic Paintbrush (One 2 1/2", One 1")
- Foam Brush
- Denatured Alcohol
- Masking Tape
- Clean Lint Free Cloth
- Paint Thinner or Mineral Spirits (Clean-up)
- Stain (Gel or Opaque Heavily Pigmented Oil Base)
- Polyurethane Top-Coat with UV Inhibitor

### PAINTING

- Use high-quality acrylic latex house paint. Outside surfaces require exterior grade paints.
- All 6 sides of door must be finished to comply with warranty.
- Apply paint when door and air are above 50 degrees and below 90 degrees Fahrenheit.
- For maximum paint adhesion, lightly scuff ODL Steel Doors with 400 grit sandpaper or fine steel wool.
- ODL Satin Smooth Fiberglass Doors are manufactured with a brush-stroke finish which promotes superior paint-adherence. No sanding is required.
- Paint application may be applied by spray, roller or brush. Refer to paint manufacturer's instructions for best results by application.
- If the door contains glass insert, follow door glass frame finishing instructions.
- If painted door is exposed to direct sunlight, darker color finishes may deteriorate quickly and require frequent inspection and maintenance.

# CLEANING & FINISHING INSTRUCTIONS

## STAINING

- Once door has been prepped, put on protective gloves.
- Using a gel stain or opaque, heavily pigmented oil base stain, mix contents thoroughly according to stain manufacturer's directions.
- Working in the prescribed order detailed in Image 1, work stain into door in a circular motion with staining rag or foam brush.

### STAINING TIP:

ODL recommends using a staining rag for superior application.

### STAINING TIP:

Only stain one area at a time. (1 Panel, 1 Horizontal, 1 Stile, etc.)



Image 1:

1. Panels & Sticking
2. Vertical Center Areas
3. Horizontal Areas
4. Face Stiles
5. Door Outer Edges

- Using a clean, dry rag remove stain by wiping in the direction of the grain. Pressure on the rag will determine the amount of stain that is removed from the door.
- Using a dry paintbrush, blend stain with light brush strokes. Stain will tend to gather in the panel corners and the brush will allow stain to be blended. Frequently clean brush with dry rag to remove stain from bristles.

### STAINING TIP:

When staining panels, excess stain will invariably get on vertical and horizontal surfaces. Before stain has a chance to dry, wipe clean with clean rag dampened with mineral spirits.

- Allow stain to fully dry per manufacturer's instructions.
- Flip door on to clean, padded surface and repeat process for second side.

## PROTECTIVE TOP-COAT

- Using a clean, dry rag remove stain by wiping in the direction of the grain. Pressure on the rag will determine the amount of stain that is removed from the door.
- Using a dry paintbrush, blend stain with light brush strokes. Stain will tend to gather in the panel corners and the brush will allow stain to be blended. Frequently clean brush with dry rag to remove stain from bristles.

### STAINING TIP:

Use light strokes to apply top coat. Bristles should bend slightly. Brush a maximum of 2 to 3 light strokes in the direction of the grain to reduce visible brush marks.

- Soapy water may be used to clean brush if polyurethane is water-based. If oil based, follow manufacturer's instructions for brush clean-up. Make sure brush is completely dry before proceeding.
- Follow top coat manufacturer's directions for applying second and third coats. A minimum of 2 coats is required to seal door. Remember to seal top and bottom edges of the door.

### CLEAN-UP TIP:

Please use caution during the clean-up phase of the staining process. Stains, paints and top-coats may contain flammable materials. Please follow all safety precautions prescribed by the manufacturer's of each product prior, during and after the finishing process.

## CONTINUED MAINTENANCE

- All finished doors will require maintenance over time. The frequency of maintenance will be based on exposure to the sun, climatic weathering and air pollutants.
- When the top-coat gloss has lost its sheen and/or the surface feels rough to the touch, it is time for the door to be top-coated.

# ADJUSTABLE HINGE INSTRUCTIONS

## STEEL EDGE DOORS

### TOOLS AND MATERIALS NEEDED

- Pencil
- Phillips Head Screwdriver
- Pry Bar
- Measuring Tape
- Safety Glasses

### STEP 1. ADD REFERENCE MARKS

Determine proper fit and use a pencil to make reference marks between the door and top and side of hinge. See Fig. 1.



FIG. 1

### STEP 2. LOOSEN HINGE SCREWS

Loosen hinge screws using a Phillips head screwdriver (**do not completely remove screws**).

### STEP 3. BREAK TEMPORARY BOND

The door is prepped for hinges using factory preset locations that are temporarily bonded in place place.

To adjust your door it is necessary to break the temporary bond by using a pry bar at the bottom **hinge side** of the door. Apply force upwards. Use caution to avoid damage to the door sweep. Once the bond is broken the hinge reinforcement plates in the door will move freely. See Fig. 2.



FIG. 2  
FACTORY PRESET



FIG. 3  
UP ADJUSTMENT



FIG. 4  
DOWN ADJUSTMENT



FIG. 5  
IN ADJUSTMENT



FIG. 6  
OUT ADJUSTMENT

### STEP 4. ADJUSTMENT DETAILS

The door can be vertically adjusted 5/8" and 1/8" in or out.

### STEP 5. UP/DOWN ADJUSTMENTS

To adjust up or down use the pry bar to lift the door to desired height then tighten the screws on all three hinges. See Fig. 3 & 4.

### STEP 6. TOP IN/OUT ADJUSTMENTS

For top in/out adjustment, use the pry bar to lift the door to desired height then tighten all screws on the bottom hinge. Adjust door in/out as needed then tighten screws on remaining hinges. See Fig. 5 & 6.

### STEP 7. BOTTOM IN/OUT ADJUSTMENTS

For bottom in/out adjustment, use the pry bar to lift the door to desired height then tighten all screws on the top hinge. Adjust door in/out as needed then tighten screws on remaining hinges. See Fig. 5 & 6.

### STEP 8. FINAL STEP

When complete, double check that all hinge screws are sufficiently secure.



215 E ROOSEVELT AVE  
ZEELAND, MI 49464  
800.253.3900 · odl.com/catalog

